

Honeywell

LYNX Touch L5210/L7000 Series Security Systems

Installation and Setup Guide

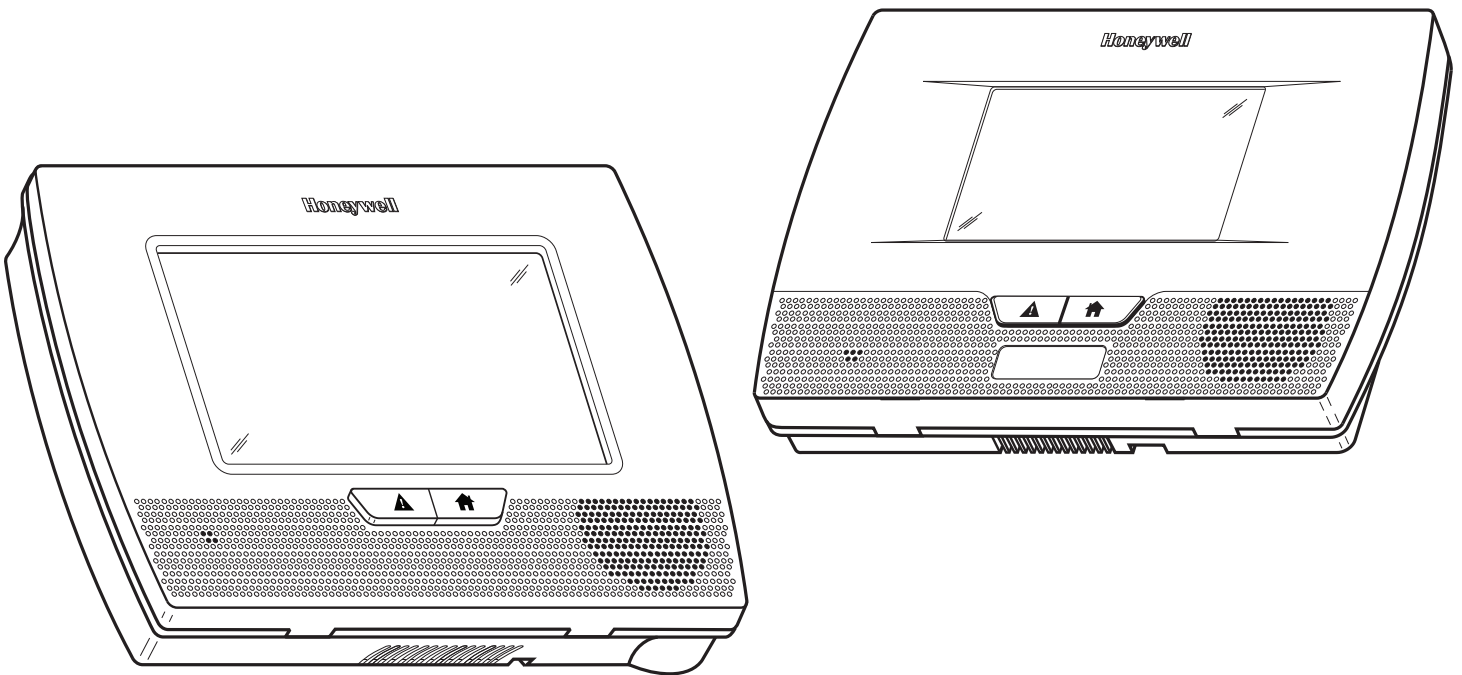

RECOMMENDATIONS FOR PROPER PROTECTION

The Following Recommendations for the Location of Fire and Burglary Detection Devices Help Provide Proper Coverage for the Protected Premises.

Recommendations for Smoke and Heat Detectors

With regard to the number and placement of smoke/heat detectors, we subscribe to the recommendations contained in the National Fire Protection Association's (NFPA) Standard #72 noted below.

- Early warning fire detection is best achieved by the installation of fire detection equipment in all rooms and areas of the household as follows: For minimum protection a smoke detector should be installed outside of each separate sleeping area, and on each additional floor of a multi-floor family living unit, including basements. The installation of smoke detectors in kitchens, attics (finished or unfinished), or in garages is not normally recommended.
- For additional protection the NFPA recommends that you install heat or smoke detectors in the living room, dining room, bedroom(s), kitchen, hallway(s), attic, furnace room, utility and storage rooms, basements and attached garages.

In addition, we recommend the following:

- Install a smoke detector inside every bedroom where a smoker sleeps.
- Install a smoke detector inside every bedroom where someone sleeps with the door partly or completely closed. Smoke could be blocked by the closed door. Also, an alarm in the hallway outside may not wake up the sleeper if the door is closed.
- Install a smoke detector inside bedrooms where electrical appliances (such as portable heaters, air conditioners or humidifiers) are used.
- Install a smoke detector at both ends of a hallway if the hallway is more than 40 feet (12 meters) long.
- Install smoke detectors in any room where an alarm control is located, or in any room where alarm control connections to an AC source or phone lines are made. If detectors are not so located, a fire within the room could prevent the control from reporting a fire or an intrusion.

THIS CONTROL COMPLIES WITH NFPA REQUIREMENTS FOR TEMPORAL PULSE SOUNDING OF FIRE NOTIFICATION APPLIANCES.

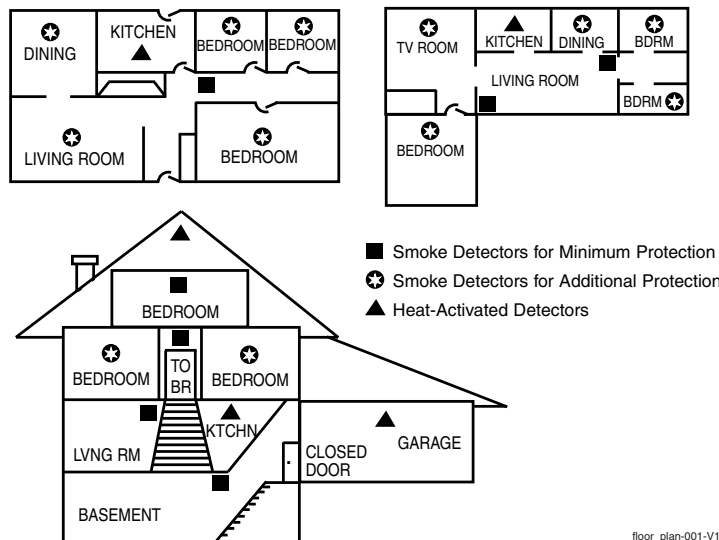

Recommendations For Proper Intrusion Protection

- For proper intrusion coverage, sensors should be located at every possible point of entry to a home or premises. This would include any skylights that may be present, and the upper windows in a multi-level building.
- In addition, we recommend that radio backup be used in a security system. This will ensure that alarm signals can be sent to the alarm monitoring station in the event that the telephone lines are out of order (alarm signals are normally sent over the phone lines, if connected to an alarm monitoring station).

Table of Contents

System Features	5
Installing the Control	7
Wall Mounting	7
Desktop Mounting	7
Wiring Overview	8
Wiring Connections	9
AC Power and Backup Battery	9
General	10
Installing the Rechargeable Backup Battery	10
Replacing the Rechargeable Backup Battery	10
Battery Selection	10
Installing/Configuring Communications & Home Automation Modules	12
General	12
Connecting and Configuring Communications Modules	12
Installing the 4GL/4GLC or 3GL/3GLC	12
Installing the ILP5	14
Installing the L5100-WiFi Module	15
Installing the L5100-ZWAVE Module	15
Installing Wireless Zones	17
General Information	17
Zones	17
Range	17
Transmitters	17
House Identification	17
Transmitter Supervision	17
Transmitter Input Types	17
Transmitter Battery Life	17
RF Sniffer Test Mode	18
Go-No-Go Test Mode	18
5800 Series Transmitter Loop Numbers	19
Mechanics of Programming	20
Navigating Menus	20
Touchscreen Display	20
Navigation Keys	21
Home Screen	21
Security Screen	22
Security Menus	22
Installer Tools Menu	22
User Tools Menu	22
General Programming Information	23
Programming	23
Enter Installer Programming Mode	23
Loading Factory Defaults	24
Select a Default Configuration	24
Exiting Programming Mode	24
Zone Response Type Definitions	25
General Information	25
Programming the Control	27
Enter Installer Programming Mode without using Installer Code	27
Change Installer Code	27
Select a Language	27
System Type	27
Program Date and Time	30
Program the Communications Module	31
Program the Z-Wave Module	34
Program Zones	35
Program Keys	38
Program Reporting	40
Program Sounder	47
Program System Settings	48
Communications Diagnostics	51
Communications Status	51
Ethernet Information	51
GSM Information	51

Table of Contents (Continued)

Communications ID Numbers	52
Test Communications	52
Setup Communications	52
Registering the LYNX Touch	52
Register through AlarmNet Direct Website	53
Register by Phone	53
Register through LYNX Touch Diagnostics	53
Register Device with PIN	54
Update Server	55
Enroll the L5100-WiFi Module	55
Enroll Using Scan Access Points	56
Manually Configure Access Points	56
WiFi Protected Set-up (WPS)	57
Factory Defaults	57
Remote Programming/Control (Downloading)	58
General Information	58
Remote Programming Information	58
Remote Programming Advisory Notes	59
System Operation	60
Key/Touchscreen Operation	60
Panic Key/Icons	60
Security Codes	60
Installer Code	60
Master Code	60
Enter/Change the Master Code by Installer	60
Secondary User Codes	61
Reset Master Code	61
Security Code Notes	61
“Follow Me” System Announcement Feature (L5210/L5210CN only)	62
“Follow Me” Reminder Feature (L5210/L5210CN only)	63
Remote Phone Control Feature (L5210/L5210CN only)	63
System Displays	64
Zone Status Displays	64
Audio Alarm Verification (Two-Way Voice Feature)	65
Activation	65
Operator Commands	65
Event Log	66
Contact ID & SIA Event Log Codes	66
Central Station Messages	67
Testing the System	68
Test Modes	68
Testing the System	68
Armed System Test	68
Dialer Test	69
Zone Discovery Mode	69
Rebooting the System	69
LYNX Touch (L5210/L7000) Programming Default Values	70
LYNX Touch (L5210CN/L7000CN) Canada Programming Default Values	73
Zone Programming Default Values	76
Zone Response Type Matrix	77
Regulatory Agency Statements	78
Limitations of this System Statement	79
UL Notices	80
SIA Quick Reference Guide	81
Specifications	82
Contacting Technical Support	83
Glossary	84
Index	85
Summary of Connections Diagram	87
Support & Warranty Information	Rear Cover

System Features

The LYNX Touch L5210 and L7000 series controls are self-contained, rechargeable wireless control/communicator that features easy installation and usage. A built-in speaker provides voice announcement of system status along with voice descriptors of each zone. An internal module (if provided) allows the LYNX Touch to communicate with the Central Station via the Internet or GSM Cellular Wireless.

UL LYNX Touch is not intended for UL985 Household Fire applications unless a 24-hour backup battery (P/N 300-03866/LYNXRCHKIT-SHA) is installed.

System Features	L5210	L7000
• 4.7-inch color graphic touch screen	✓	n/a
• 7.0-inch color graphic touch screen	n/a	✓
• Message center (for user recorded messages)	✓	✓
• Voice announcement of system and zone status	✓	✓
• User-selectable voice chimes	10	10
• Reminders	✓	✓
• Automatic stay arming	✓	✓
• Night stay arming	✓	✓
• Remote phone control	✓	n/a
• Speaker phone operation	✓	n/a
• "Follow me" reminder and system announcements	✓	n/a
• User Codes (Installer, Master, Guest, Duress)	32	48
• Panic Functions (Police, Fire, Medical)	✓	✓
• Programmable reminders	16	16
• Video Camera Control (requires installation of a L5100 WiFi Module)	1	4
• Supports Mobile Devices (Tablet, iPad, etc.) that duplicate functions of the LYNX Touch (i.e.; Security, Web Content Home Automation and Video Control)	4	4
Home Automation (requires installation of a L5100 Z-Wave Module)		
• Control Z-Wave Home Automation devices	✓	✓
- Thermostats	3	4
- Door locks	4	6
- Devices (outlets, switches, lamps/appliances)	40	40
• Supports Garage Door Feature (5877 Relay Receiver)	3	4
• Programmable scheduled events, rules and scenes	20	20
• Supports Z-Wave Network Wide Inclusion (NWI) Mode	✓	✓
Zones and Devices		
• Hardwire Zone (EOLR, N/C, N/O)	1	1
• Wireless Zones (5800 Series transmitters)	63	79
• Wireless Button (Keyfob) Zones (5800 Series transmitters)	16	24
• Garage Door Zones	3	4
• Temperature Zones	6	8
• Resident Monitor Zone Types	2	2
• Supports Wireless Keypads	✓	✓
• Built-in Case tamper	✓	✓

System Features

	L5210	L7000
Communication		
• ADEMCO Contact ID	✓	✓
• SIA (DC-03)	✓	✓
• Internet Central Station communication	✓	✓
• GSM cellular Central Station communication	✓	✓
• WiFi Central station communication	✓	✓
• Two-way voice communication	✓	✓
• Supports AlarmNet remote services	✓	✓
System Power		
• Primary Power: Plug-in Power Supply, 110VAC to 9VDC, 2.7A output P/N 300-04705V1 or 300-04065V1 (300-04063V1 or 300-04064V1 in Canada)	✓	✓
• Backup battery: Rechargeable nickel-metal hydride battery pack rated at 7.2Vdc. (P/N 300-03864-1/LYNXRCHKIT-SC or 300-03866/LYNXRCHKIT-SHA)	✓	✓
Alarm Output		
• Built-in sounder	✓	✓
• Steady output for burglary/panic	✓	✓
• Temporal (3) pulse output for fire alarms	✓	✓
• Temporal (4) pulse output for carbon monoxide alarms	✓	✓
• Long Range Radio (GSM)/Audio Alarm Verification	✓	✓
• Trigger output	✓	✓
Programming		
• Options stored in EEROM	✓	✓
• Can be uploaded, downloaded or controlled via IBM-compatible computer using Compass downloader software and specified HAYES or Honeywell CIA modem or via capable GSM, IP or WiFi communications module	✓	✓*
* L7000 requires GSM, IP or WiFi communications		
• Flash downloading	✓	✓
Other Features		
• Exit error feature (detects difference between an actual alarm and exit alarm caused by leaving a door open after the exit delay expires)	✓	✓
• Event log storage (total events)	128	256
• RF jam detection	✓	✓
• Installer programmable user (Follow Me) phone numbers	2	n/a
• Advanced Protection Logic™ (APL) (Minimizes the likelihood of the system being disabled before notification can be sent to the Central Station indicating that the premise has been compromised.)	✓	✓
• Displays web content including Local News, Weather and Traffic (requires Total Connect Service)	✓	✓
• Dealer/Central Station messages (requires Total Connect Service)	✓	✓

Installing the Control

Wall Mounting

For wall mounting follow the steps below and refer to the appropriate figure for the LYNX Touch L5210 OR L7000 control.

1. Release the front case assembly from the back case by depressing the two locking tabs at the top of the unit with the blade of a medium size screwdriver.
2. Separate the front and back case assemblies by rotating the front case so that it is perpendicular to the back case and unsnapping (releasing) the two hooks from the back case.
3. Feed the field wiring through the appropriate openings in the back case. Use tie-wraps to secure the wiring to the built-in wire loops as needed.
4. Mount the back case to a sturdy wall.
5. If required, install an additional mounting screw in the case tamper (see Detail A).
6. Attach the front and back cases by connecting the hooks on the front case to the attachments on the rear case. Once attached, the hooks will support the front case and allow you to make the wiring connections.
7. After all wiring connections have been made, snap the front case and back case closed and ensure that the control is secured by the locking tabs.

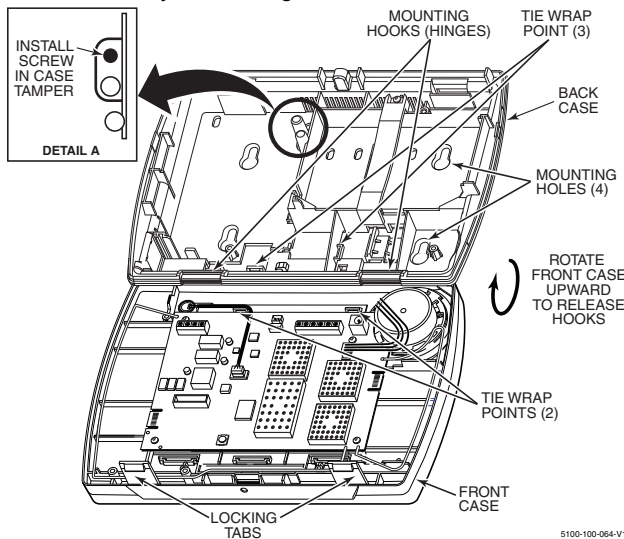

L5210 Wall Mounting

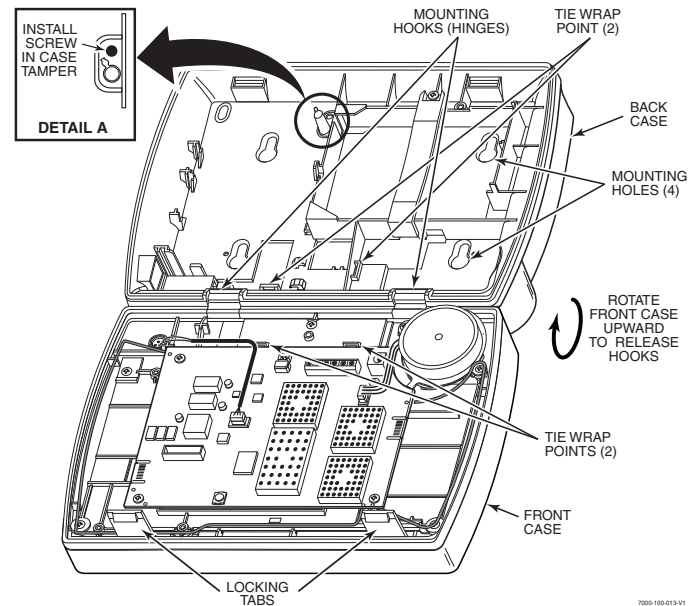

L7000 Wall Mounting

Desktop Mounting

For desktop mounting, the optional mounting base (model L5000DM OR L7000DM, purchased separately) must be used.

1. Slide the Control Panel onto the mounting base locking tabs.
2. Bring all wiring through the bottom of the mounting base, using one of the wire entry locations, before making connections to the Control Panel.
3. Use tie-wraps to secure the wiring to the built-in wire loops as needed.
4. Use the supplied screws to secure the Control Panel to the mounting base.

Installing the Control

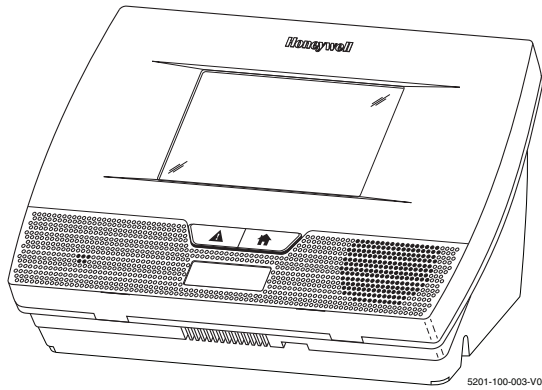

L5210 Desk Mount

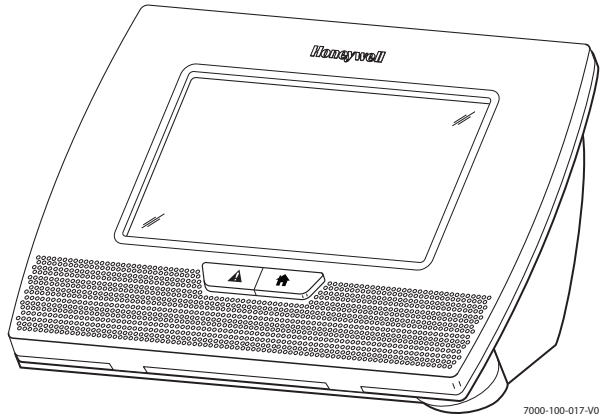

L7000 Desk Mount

Wiring Overview

The following summarizes the electrical connections associated with the L5210/L5210CN and L7000/L7000CN. Refer to the Wiring Connections paragraph and the Summary of Connections diagram on the inside back cover when making connections.

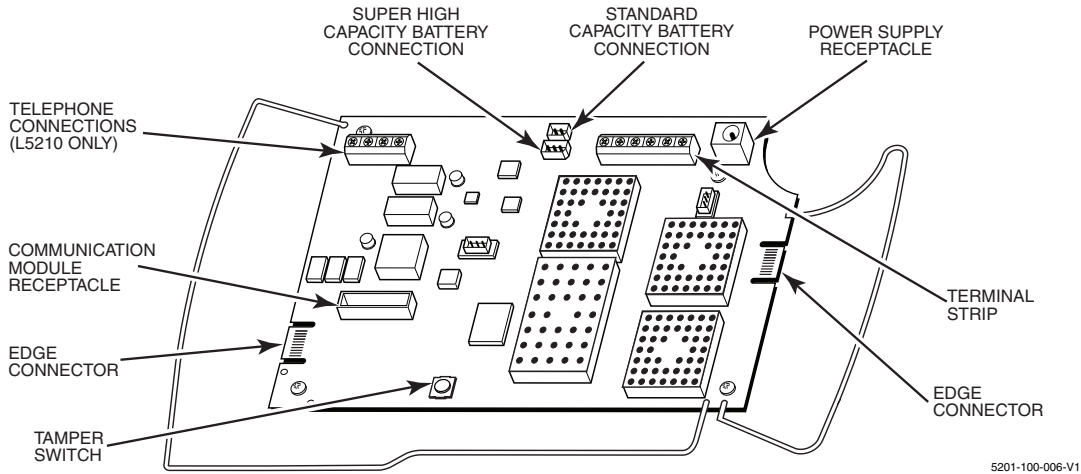

5201-100-006-V1

Wiring Connections

1. **Make Earth Ground Connection** - The designated earth ground terminal EGND must be terminated in a good earth ground for the lightning transient protective devices in this product to be effective. The following are examples of good earth grounds available at most installations:

Metal Cold Water Pipe - Secure a non-corrosive metal strap (copper is recommended) to the pipe that is electrically connected and secured to which the ground lead is electrically connected and secured.

AC Power Outlet Ground - Available from 3-prong, 120VAC power outlets only. To test the integrity of the ground terminal, use a three-wire circuit tester with neon lamp indicators, such as the UL Listed Ideal Model 61-035, or equivalent, available at most electrical supply stores.

- a. Connect terminal EGND to a good earth ground as shown on the Summary of Connections.

2. **Make Phone Line Connections** - For local or full line seizure follow the appropriate steps below.

Local Seizure

- a. Connect the incoming phone line to the terminals TIP and RING on the Control as shown on the Summary of Connections.
- b. Connect the handset phone lines to terminals H/S T (TIP) and H/S R (RING) as shown in the diagram.

Full Line Seizure: The control must be placed in series with the incoming phone line. Plugging the Direct Connect Cord directly into the RJ31X jack, allows the control to seize the phone line when an alarm occurs and normal phone line usage by the premises phones if the plug needs to be removed.

- c. Cut the incoming RING and TIP phone lines (typically red and green, respectively) and connect them to RJ31X terminals 4 (red) and 5 (green).

- d. Connect the premises end of the cut RING and TIP wires to RJ31X terminals 1 (grey) and 8 (brown) respectively.

- e. Wire the flying leads of a Direct Connect Cord to the control's phone terminals as shown in the diagram.

- f. Plug the Direct Connect Cord into the RJ31X jack.



HARDWIRED ZONE: If the EOLR is not at the end of the loop, the zone will not be properly supervised, and the system may not respond to an open circuit on the zone.

3. **Hardwired Zone Connections** - One EOLR supervised zone supports both open circuit and closed circuit devices and has a response time of 350msec. Maximum zone resistance: 300 ohms, plus EOLR

Note: The hardwire zone cannot be used as a fire zone.

- a. Connect sensors/contacts to the hardwired zone terminals GND (-) and HWZ1 (+). Refer to the Summary of Connections diagram.
- b. Connect closed circuit devices in series in the high (+) side of the loop. The EOL resistor must be connected in series with the devices, following the last device.
- c. Connect open circuit devices in parallel across the loop. The 2000-ohm EOLR must be connected across the loop at the last device.

4. **AC Power Connections** - Connect the Power Supply to the receptacle on the Control.

OR

Connect wires from the Power Supply to +9VDC and EGND terminals as shown on the summary of connections diagram.

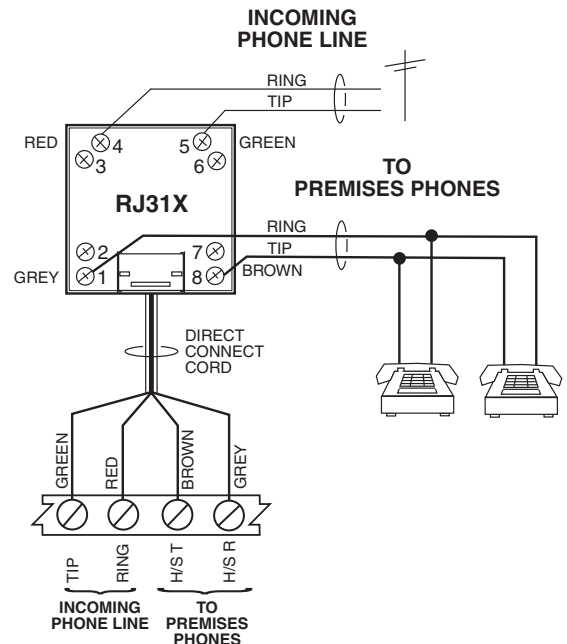

FULL LINE SEIZURE CONNECTIONS

WIRING TABLE

MAXIMUM DISTANCE BETWEEN POWER SUPPLY AND CONTROL	WIRE GAUGE
Up to 11 feet	# 22
Up to 20 feet	# 20
Up to 26 feet	# 18

5000-100-094-V4

AC Power and Backup Battery

General

The system is powered by a 9 Volt DC, 2.7 Amp Plug-in Power Supply, 300-04705V1, or 300-04065V1 (300-04063V1 or 300-04064V1 in Canada). Refer to the wiring table below for wire gauge and length. In the event of an AC power loss, the system is supported by a long life backup battery that is supervised for connection and for low voltage conditions. If the battery is missing, or a low battery condition is detected, a “low battery” message is displayed and a report is sent to the Central Station. In addition, the system will beep once every 45 seconds to audibly indicate a low battery condition (press any key to stop the beeping).



Use only the provided 300-04705V1, or 300-04065V1 (300-04063V1 or 300-04064V1 Canada) Power Supply. Do not plug the power supply into the AC outlet until after all wiring connections have been made. Ensure the cover is snapped closed prior to applying AC power.

The LYNX Touch is equipped with an integral, replaceable, rechargeable battery pack rated at 7.2Vdc. Select the appropriate battery pack, based on the installation’s requirement, and install the battery pack. Refer to the appropriate figure for the LYNX Touch L5210 OR L7000 control.

Installing the Rechargeable Backup Battery

1. Remove battery retainer.
2. Insert battery pack into back case.
3. Install battery retainer.
4. Secure battery retainer with the provided screw.
5. Secure battery wiring in the wire routing clips (3).
6. Connect the battery connector to the receptacle on the PC board.
7. After the wiring connection has been made, snap the front and the back case closed.
8. Plug the power supply into a 24-hour, 110VAC unswitched outlet. Upon power-up, the system will display “Checking System Integrity” and then the “System Standby!” screen will be displayed.

Replacing the Rechargeable Backup Battery

1. When battery replacement is required, unplug the power supply from the wall outlet, and open the Control Panel cover.
2. Disconnect the battery pack connector from the receptacle on the PC board.
3. Remove the screw that secures the battery retainer and remove the battery retainer.
4. Remove the battery pack from the back plate.
5. Install a replacement battery pack (P/N 300-0364-1/LYNXRCHKIT-SC OR P/N 300-0366/LYNXRCHKIT-SHA) into the back case.
6. Route the battery cable through the channel (cutout) on the left side of the compartment.
7. Install the battery retainer.
8. Secure battery retainer with the provided screw.
9. Secure battery wiring in the wire routing clips (3).
10. Connect the battery connector to the receptacle on the PC board.
11. After the wiring connection has been made, snap the front and the back case closed.
12. Plug the power supply into a 24-hour, 110VAC unswitched outlet. Upon power-up, the system will display “Checking System Integrity” and then the “System Standby!” screen will be displayed.



Ensure the Control Panel assembly is snapped closed prior to applying AC power. Rechargeable batteries may take up to 48-hours to fully charge. The “Low Battery” message should clear within four hours or by entering Test Mode.

Battery Selection

The LYNX Touch L5210 and L7000 controls are equipped with an integral, replaceable, rechargeable battery pack rated at 7.2Vdc. Select the appropriate battery pack, based on the installation’s requirement, and install the battery pack.

Battery Part Number	Battery StandbyTime	Low Battery Notification
300-03864-1/LYNXRCHKIT-SC	4-hours (minimum)	Approximately 1-hour before battery depletion
300-03866/LYNXRCHKIT-SHA	24-hours (minimum)	At least 1-hour before battery depletion

AC Power and Backup Battery

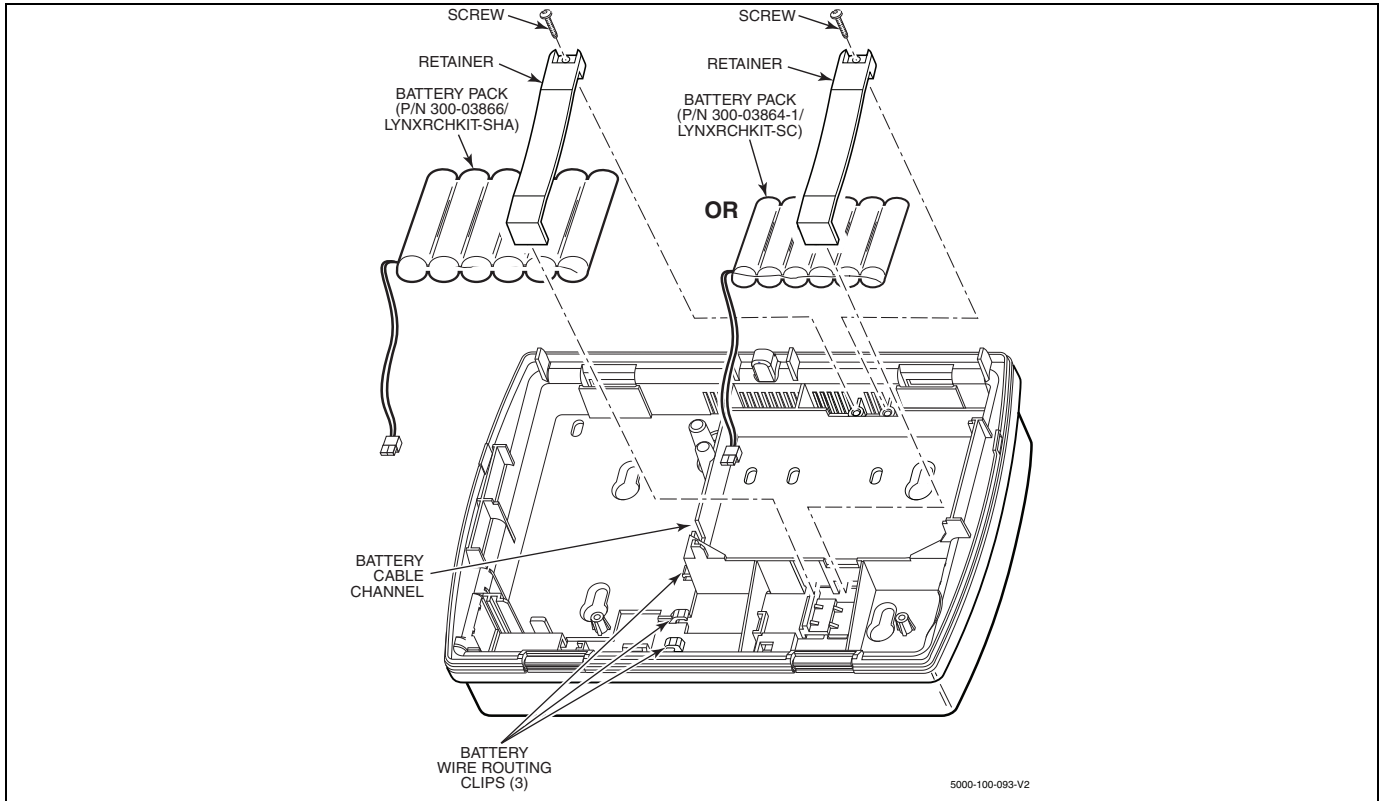

L5210 Battery Installation

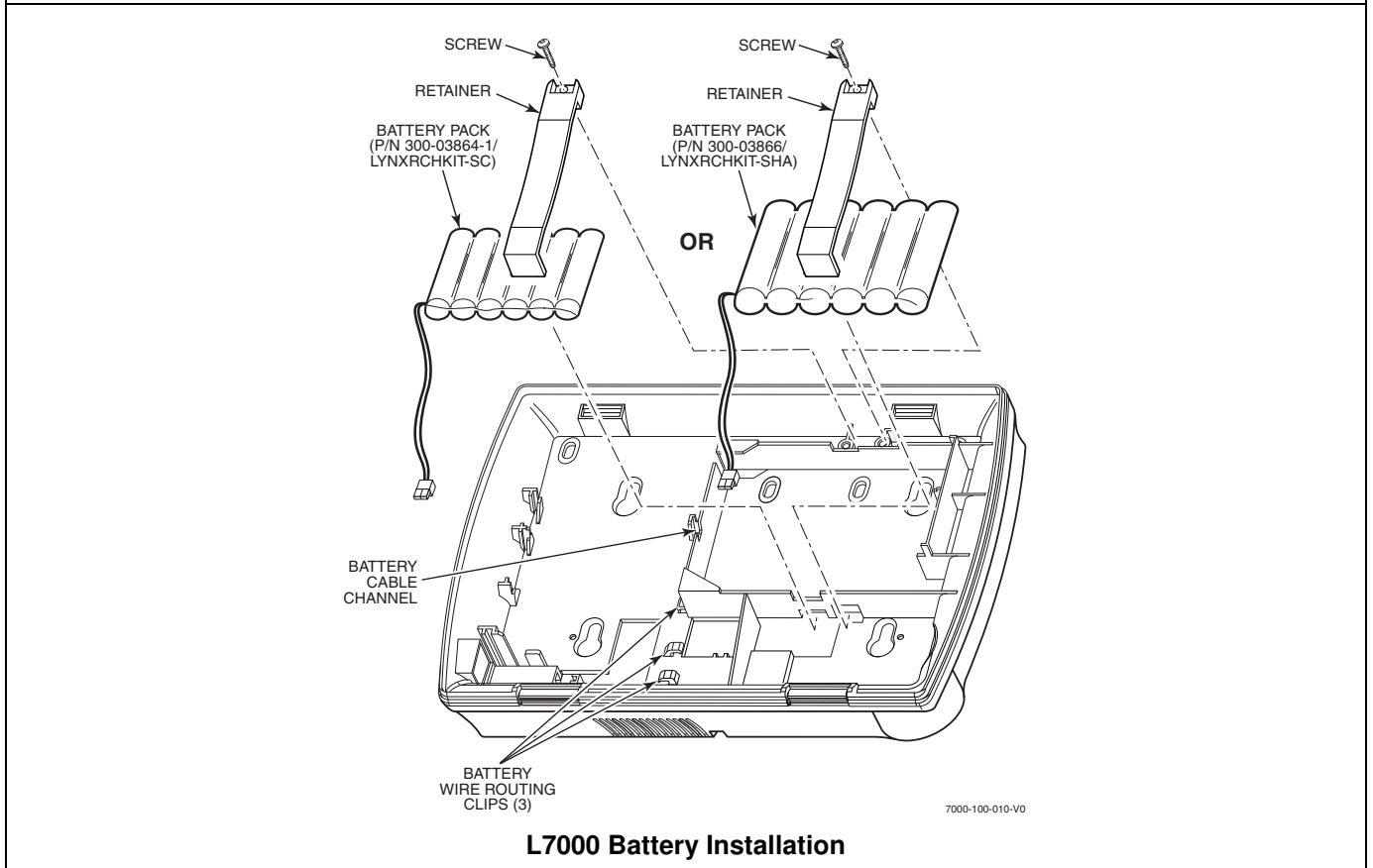

L7000 Battery Installation

Installing/Configuring Communication & Home Automation Modules

General

This LYNX Touch controls support Central Station reporting using wireless/cellular (GSM) WiFi and hardwire (IP) communications modules. They also support upload/download programming capability via the Internet or a Private local area network (Intranet). This allows site maintenance independent of Central Station monitoring, and modification to sites globally via the Internet or through a private LAN. Refer to the instructions provided with the GSM, WiFi or IP Communications Module being installed for additional information regarding its installation, programming, and registration. Additionally, the installation of a Z-Wave module allows the control to support Home Automation functions. (refer to the Home Automation Guide (P/N 800-19979 for additional information.) The controls are compatible with the following AlarmNet Communications and Home Automation Modules:

- 4GL/4GLC or 3GL/GLC GSM Communication Module
- ILP5 Ethernet Communications Module
- L5100-WiFi WiFi Communications Module
- L5100-ZWAVE Home Automation Module

Refer to the appropriate figure for the LYNX Touch L5210 OR L7000 control when installing the selected Communication and/or Automation Module(s).

Communications Module 24-Hour Standby Power

If 24-hour standby is required, the Super High Capacity battery (P/N 300-03866/LYNX-RCHB-SHA) must be installed in the control.



RF Exposure

WARNING: The LYNX Touch must be installed to provide a separation distance of at least 7.8 in (20 cm) from all persons and not co-located or operated in conjunction with any other transmitter except in accordance with FCC multi-transmitter product procedures.

Connecting and Configuring GSM and IP Communication Modules

Connect and configure the communications GSM or IP module as follows:

Installing the 4GL/4GLC or 3GL/3GLC Communications Module



Ensure that SIM card and the connector board are securely installed in the 4GL/4GLC or 3GL/3GLC before installing the communications module in the LYNX Touch.

1. Install the communications module into the LYNX Touch control front case. Ensure that the connector board is properly seated into the receptacle on the control.
2. Secure the communications module with the three provided screws.
3. Enable the communications module device, configure alarm reporting and module supervision and register the device. Refer to the "Program the Communications Module" and "Communications Diagnostics" sections.



The communications module must be registered with AlarmNet before downloading or alarm reporting can take place.

Installing/Configuring Communication & Home Automation Modules

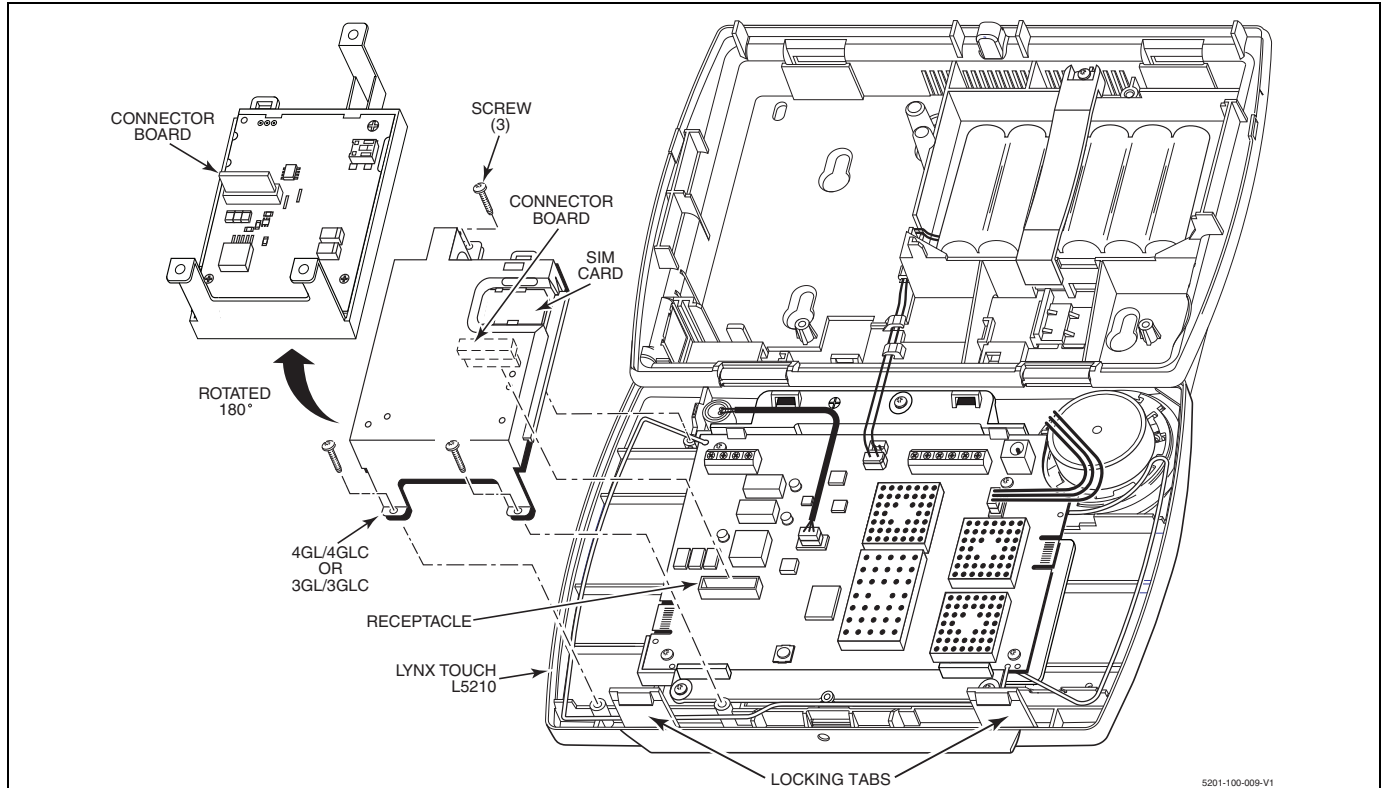

L5210 GSM Communications Installation

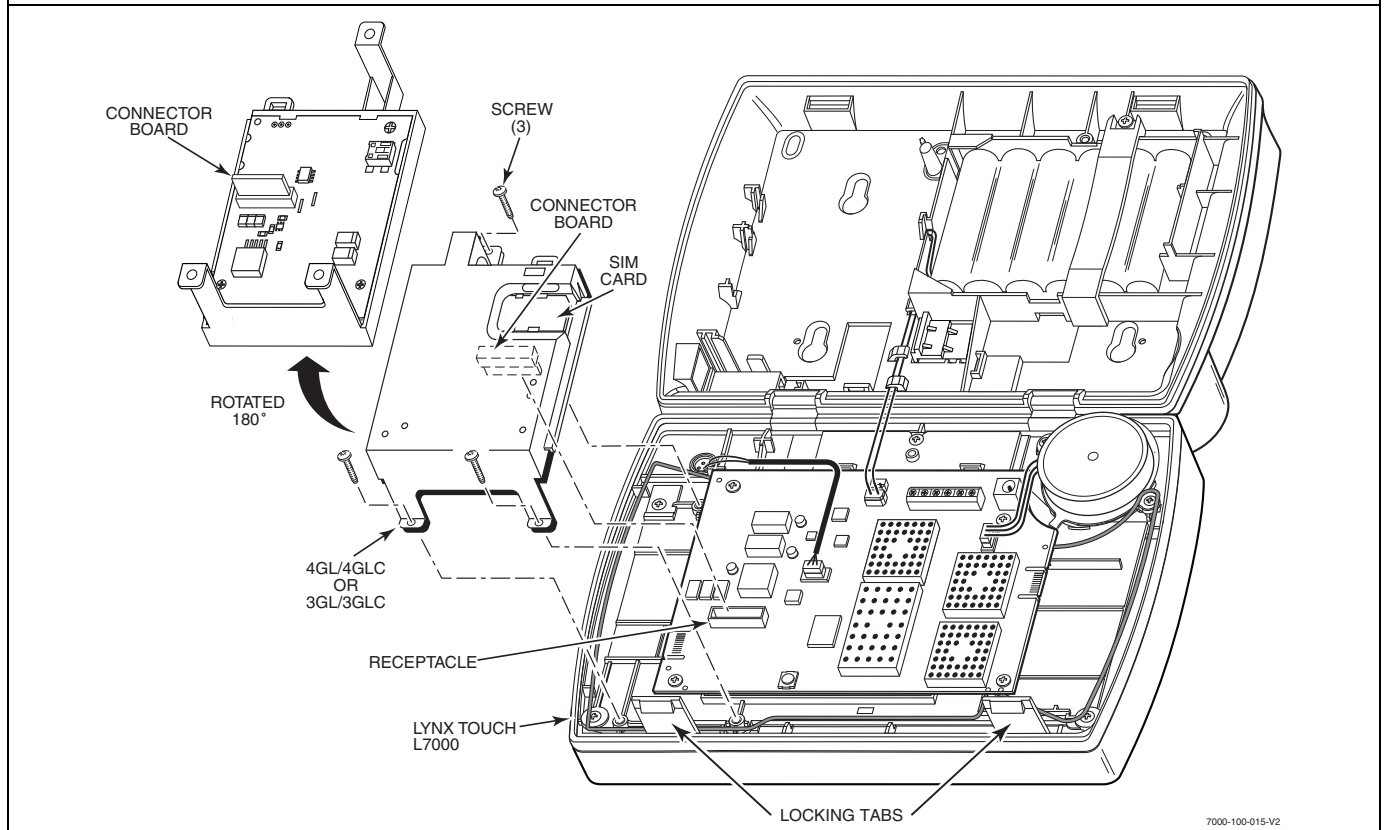

L7000 GSM Communications Module Installation

Installing/Configuring Communication & Home Automation Modules

Installing the ILP5 Ethernet Communications Module



Do not install the ILP5 if the L5100-WiFi communications module is being installed.

Ensure that the connector board and cable are securely installed in the ILP5 before installing the communications module in the LYNX Touch.

1. Using a wire cutter or knife cut the plastic tabs that secure the ILP5 spacer to the back case of the LYNX Touch.
2. Remove the ILP5 receptacle knockout from the left side of the LYNX Touch back case.
3. Install the ILP5 into the LYNX Touch control front case. Ensure that the connector board is properly seated into the receptacle on the control.
4. Secure the ILP5 with the three provided screws.
5. Insert the ILP5 receptacle and spacer into the slot on the back case.
6. Secure the communications cable to the tie wrap point on the ILP5 with the provided tie wrap.
7. Connect the Ethernet cable to the RJ45 receptacle.
8. After closing the panel, enable the ILP5 and configure alarm reporting and module supervision and register the device. Refer to the “Program the Communications Module” and “Communications Diagnostics” sections.

Alternate Installation (Refer to the Alternate Installation as shown on the figure below)

1. Install the ILP5 into the LYNX Touch control front case. Ensure that the connector board is properly seated into the receptacle on the control.
2. Secure the ILP5 with the three provided screws.
3. Insert the ILP5 receptacle into the slot on the back case as shown on the figure below.
4. Secure the communications cable to the tie wrap point on the ILP5 with the provided tie wrap.
5. Connect the Ethernet cable to the RJ45 receptacle.
6. After closing the panel, enable the ILP5 and configure alarm reporting and module supervision and register the device. Refer to the “Program the Communications Module” and “Communications “Diagnostics” sections.



The communications module must be registered with AlarmNet before downloading or alarm reporting can take place.

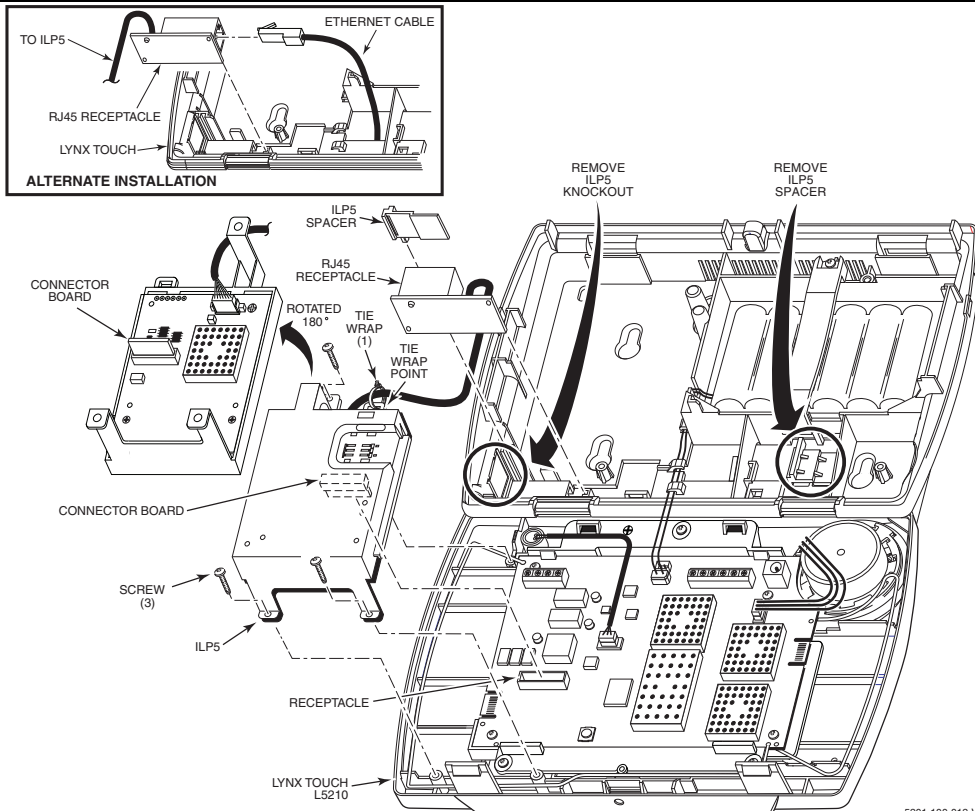

L5210 IP Communications Module Installation

5201-100-012-V1

Installing/Configuring Communication & Home Automation Modules

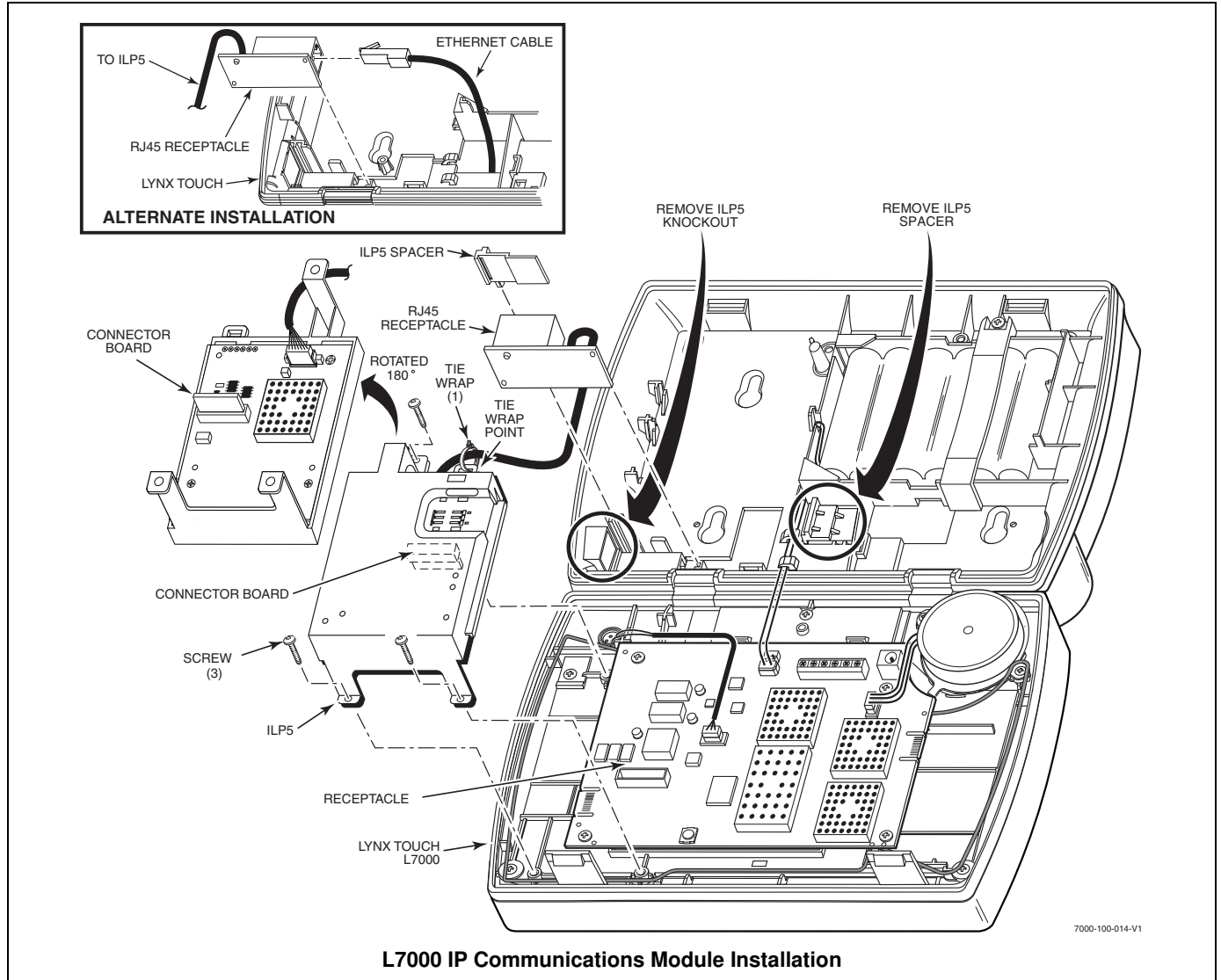

L7000 IP Communications Module Installation

Installing the L5100-WiFi module



Do not install the L5100-WiFi if the ILP5 Ethernet communications module is being installed.

1. Install the L5100-WiFi into the LYNX Touch control front case as shown below. Ensure that the receptacle is properly seated into the edge connector on the right (speaker) side of the control's circuit board.
2. After closing the panel, enable the L5100-WiFi module, configure alarm reporting and module supervision and register the device. Refer to the "Program the Communications Module" and "Communications Diagnostics" sections.



The communications module must be registered with AlarmNet before downloading or alarm reporting can take place.

Installing the L5100-ZWAVE Home Automation module

1. Enable the L5100-ZWAVE module. Refer to the "Program the Z-Wave Module".
2. Install the L5100-ZWAVE into the LYNX Touch control front case as shown below. Ensure that the receptacle is properly seated into the edge connector on the left (TELCO terminal) side of the control's circuit board.

Installing/Configuring Communication & Home Automation Modules

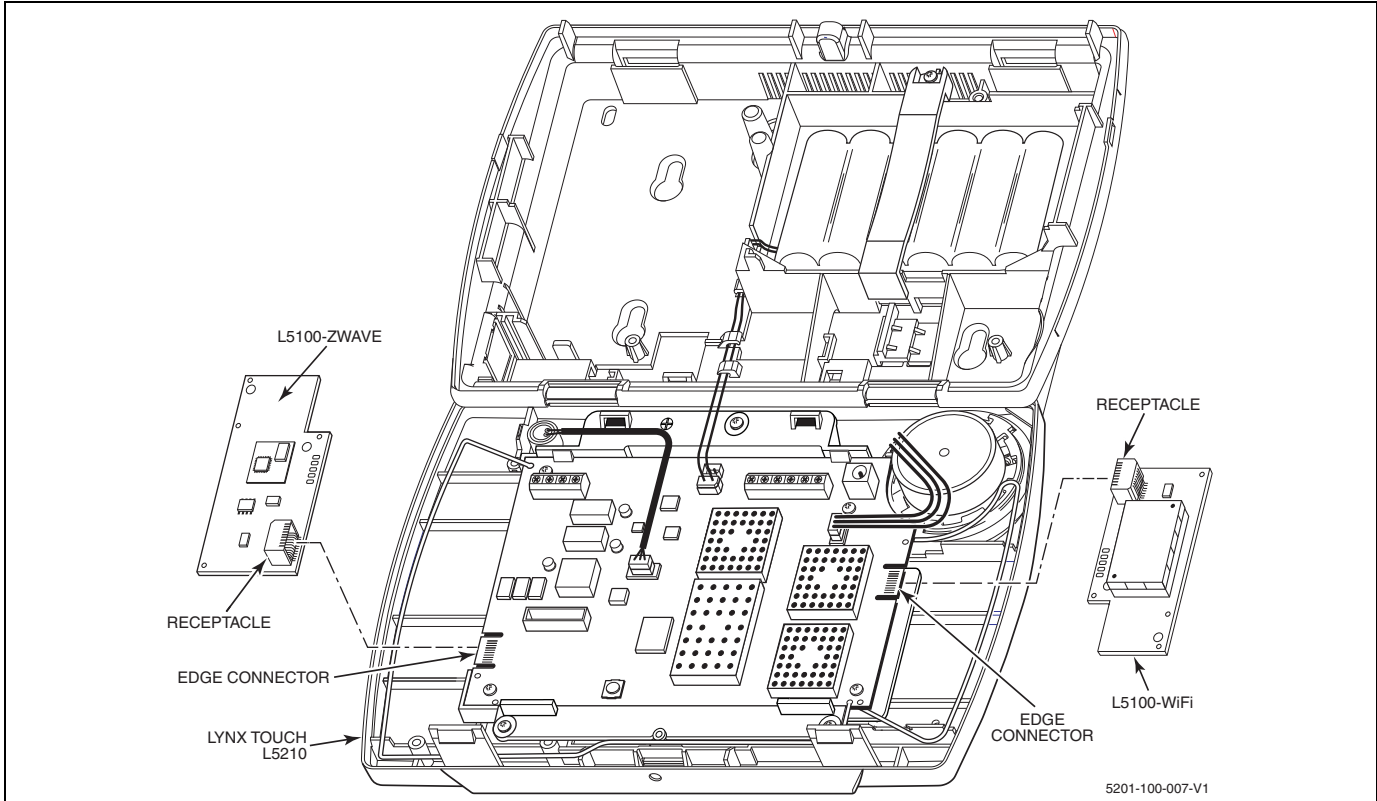

L5210 Z-Wave Automation & WiFi Communications Module Installation

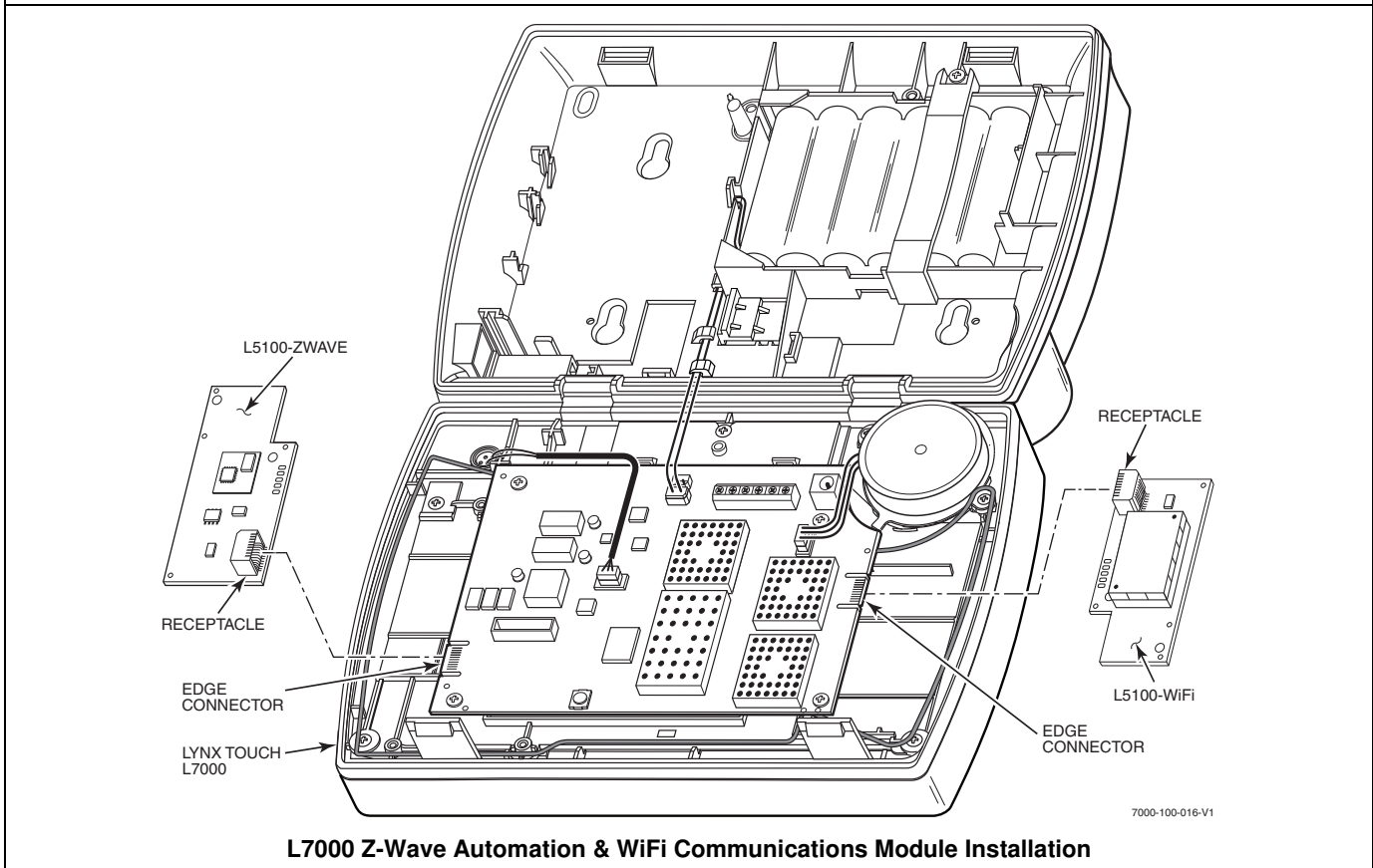

L7000 Z-Wave Automation & WiFi Communications Module Installation

Installing Wireless Zones

General Information

Zones

The L5210 and L7000 controls respectively support up to 79 and 103 total wireless zones using 5800 Series transmitters, and wireless buttons.

Range

The built-in RF receiver is capable of detecting signals from wireless transmitters within a nominal range of 200 feet.

Transmitters

5800 Series transmitters have built-in serial numbers that must be entered into the system using the “Zones” programming section, or input to the control via the downloader. 5800 Series transmitters (except the 5800RL) do not have DIP switches. Each transmitter's zone number is also programmed into the system in the “Zones” programming section. Some transmitters, such as the 5816 can support more than one "zone" (referred to as loops or inputs). On the 5816, for example, the wire connection terminal block is loop 1; the reed contact is loop 2. Each loop must be assigned a different zone number.

For button transmitters (RF "keys") such as the 5804, a unique zone number must be assigned to each individual button used on the transmitter. Each button on the transmitter also has a pre-designated loop or input number, which is automatically displayed.

The 5816 Transmitters do not have EOL supervision of their loop wiring, which must not exceed 3 feet.

UL The 5800PIR-OD, 5800RL, 5800SS1, 5804E, 5804BD, 5804BDV, 5814, 5816TEMP, 5821, 5828/5828V, 5877 and 5878 wireless transmitters have not been evaluated by UL/ETL.

House Identification

If a 5804BD/5804BDV or 5828/5828V Wireless Keypad is being used in conjunction with the system, a RF House Code (House ID) Code (01–31) must be programmed, (see the “System Type” programming section) to establish proper communication, and the keypad must be set to the same code. House ID 00 disables all wireless keypads. A House ID is not necessary for other 5800 Series transmitters.

Transmitter Supervision

With the exception of some transmitters/keypads that may be carried off-premises (5804BD, 5804BDV and 5804E), each transmitter is supervised by a check-in signal that is sent to the receiver at 70–90 minute intervals. If at least one check-in is not received from each supervised transmitter within a 12-hour period, the "missing" transmitter zone number(s) and "Supervision" will be displayed. The supervision for a particular transmitter in the system that may also be carried off the premises may be turned off by entering it as an Unsupervised type, as described in the “Program Zones” section. 5800 Series transmitters have built-in tamper protection and will annunciate as a fault condition if covers are removed. In Canada the RF supervision period is 3-hours for Fire zones and 12 hours for all other zone types.

Transmitter Input Types

Each of the transmitters has one or more unique factory-assigned input (loop) ID codes. Each of the inputs requires a programming zone (e.g., a 5804's four inputs require four button zones). Transmitters can be entered as one of the following types (see transmitter's instructions for appropriate input type):

Type	Description
Supervised	Sends periodic check-in signals, as well as fault, restore, and low battery signals. The transmitter must remain within the receiver's range.
Unsupervised	Sends periodic check-in signals, as well as fault, restore, and low battery signals, but the control does not supervise the check-in signals. The transmitter may be carried off-premises.
(Unsupervised) Button	Sends only fault signals. Transmitters do not send low battery signals until they are activated. The transmitter may be carried off-premises.

Transmitter Battery Life

- Batteries in the wireless transmitters may last from 4–7 years, depending on the environment, usage, and the specific wireless device being used. Factors such as humidity, high or low temperatures, as well as large swings in temperature may all reduce the actual battery life in a given installation. The wireless system can identify a true low battery situation, thus allowing the dealer or user of the system time to arrange a change of battery and maintain protection for that point within the system.
- Button-type transmitters should be periodically tested for battery life. The 5804BD, 5804BDV, and 5804E button transmitters have replaceable batteries.

Installing Wireless Zones

5800 Series Transmitter Loop Numbers

(Refer to this information when programming transmitters)

The following illustration shows the compatible transmitters, their associated input types and loop designations.

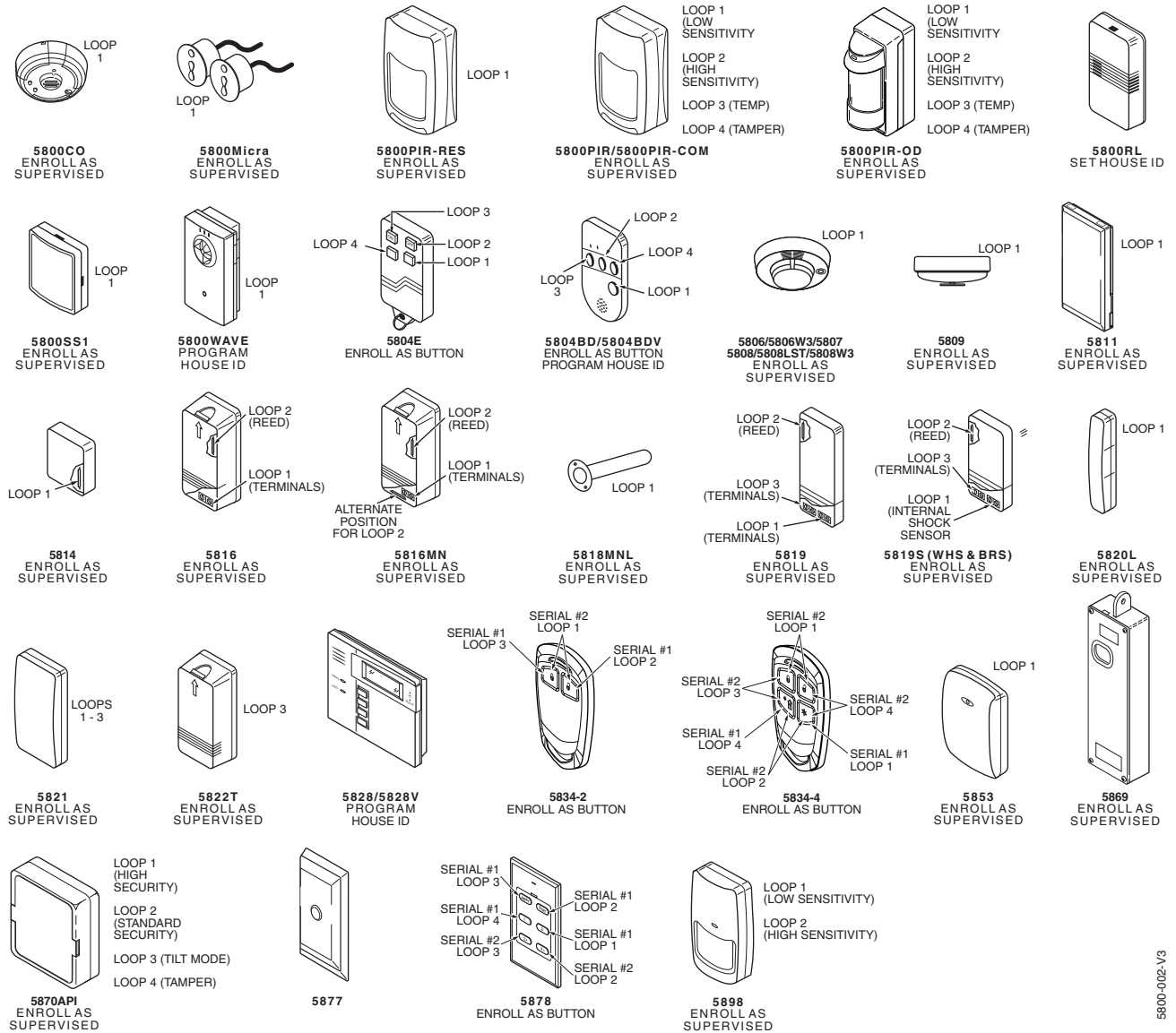

- Notes:**
- (1) The 5806W3 smoke detector must be used in SIA applications.
 - (2) Button type devices send only fault and low battery signals; no restore or check-in signals. Supervised devices send periodic check-in signals, faults, restore and low battery signals. Unsupervised devices send periodic check-in signals, faults, restore and low battery signals but the control does not supervise the check-in signals.
 - (3) If an external sounder is required, the 5800WAVE should be used.
 - (4) The 5804E and 5834-4 encrypted (High-Security) devices must be activated while the system is in Go-No-Go Test Mode. Refer to the transmitter's Installation Instructions for complete details. The system will confirm the enrollment of the encrypted device by beeping two times
 - (5) The 5800PIR-OD, 5800RL, 5800SS1, 5804E, 5804BD, 5804BDV, 5814, 5816TEMP, 5821, 5828/5828V, 5877, and 5878 wireless transmitters have not been evaluated by UL/ETL.

Mechanics of Programming

Navigating Menus

Touchscreen Display

LYNX Touch's Liquid Crystal Display (LCD) touch-screen displays variable icons and text on "screens". The screen displays status icons and associated text, the current time and date, system status information and menu choices. The Menu area includes a list of commands, or choices that apply to the current selection. The status area provides information about various system events and a colored bar also provides an indication of system status. A "Home Screen" is displayed whenever power is applied to the system. In addition, the "Home" Function key is lit Green when the system is ready or flashes when it is not. When the system is Armed the "Panic" Function and "Home" Function keys are both lit red.

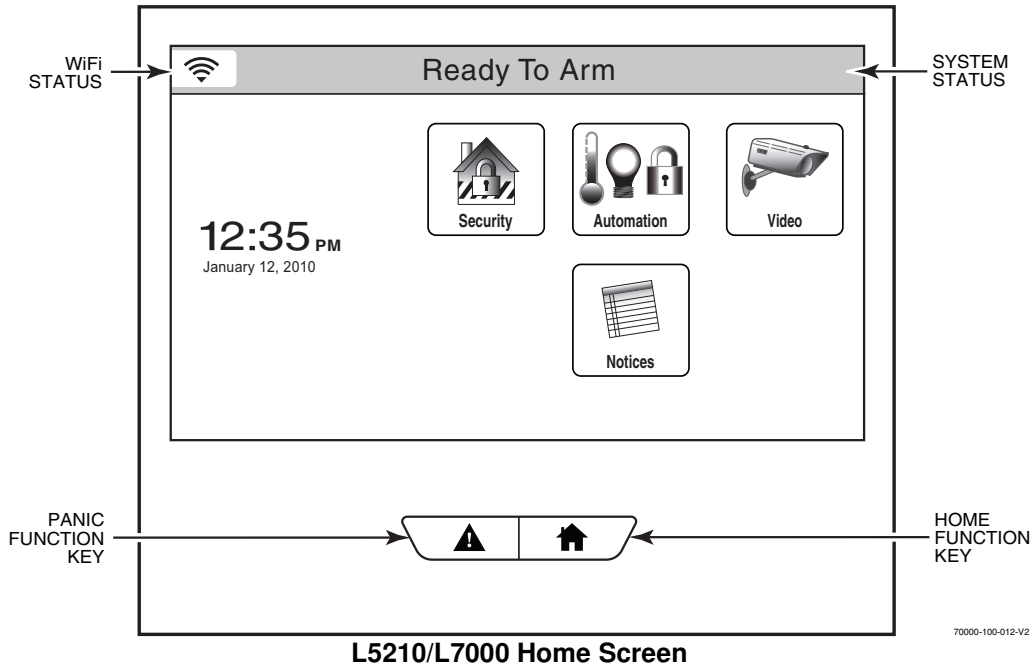

Key	Description
	Panic key - Initiates panic alarm options when depressed for 4 seconds.
	Home key - Used to exit from a screen or return to the home screen

Mechanics of Programming

Navigation Keys

Navigating through the screens is accomplished by lightly touching the icons or menu items on the touch-screen. Once activated, the control advances to the next screen. Selecting the “Home” (cancel) key or the “⏪” Key will return you to the previous screen at any time unless System Programming mode is active. By touching (selecting) an icon or key the system, depending on the function, advances to another screen, toggles between options or scrolls through multiple options that can be selected. The system provides a prompt when a specific input is required.

Note: You may find it convenient to adjust the volume setting before entering the Program Mode. This will allow you to clearly hear the feedback announcements or system beeps from the system’s built-in speaker. To adjust the volume, select “More” on the “Security Screen” and then select “Settings”. Adjust the volume using the slide displayed on the Settings screen and then select “Save” to accept. Upon exiting the Program Mode, the system resets the volume to the default value (mid-level).

Home Screen

System Status is displayed at the top of screen. In addition to the system status, the Home Screen displays the current date and time and Security, Automation, Video and Notices icons. When Total Connect Services are connected and web content is enabled, Weather, News, Traffic and Notices icons are displayed along with the current weather forecast and a 5-Day Forecast button.

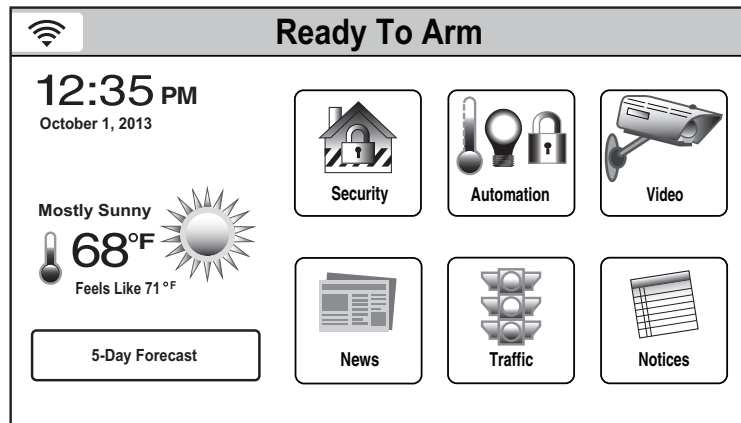

Home Screen with Total Connect Services

Icon or Button	Function
Security	Provides access to Security Screen
Automation	Provides access to Automation Screen
Video	Provides access to Video Screen
News	Provides access to News Screen
Traffic	Provides access to Traffic Screen
Notices	Provides access to Dealer Notification Message Screen
Weather	Provides local forecast and severe weather alerts
5-Day Forecast	Provides access to local 5-Day Weather Forecast Screen

Mechanics of Programming

Navigating Menus

Security Screen

System Status is displayed at the top of each screen and the time and date are displayed at the bottom of the Security Screen. The Security menu Screens differ between the LYNX Touch L5210 and the L7000 versions. Refer to the paragraphs below for additional information.

Security Menu

The Security Screen consists of two pages. The first page displays the system status and selection “icons” and “tabs”. The displayed pages and options may vary slightly depending upon the devices and services that are installed in or connected to the system.

Selection	Function
Zones	Provides access to Zone information and options.
System	Provides information about system status
Arm Away	Used to Arm the system in Away mode (displayed on both Home Screen pages).
Arm Stay	Used to Arm the system in Stay mode (displayed on both Home Screen pages).
Message	Provides access to Message Center.
Phone	Provides access to Speaker Phone mode. (if programmed L5210 only)
Delay/Instant	Used to toggle between exit delay and instant arming options
More	Advances system to second page of the Home Screen.

The second page also displays the system status and additional selection “icons” and “tabs”.

Selection	Function
Tools	Provides access to Installer and User Programming Menus (Master Code required for access).
Arm Away	Used to Arm the system in Away mode (displayed on both Home Screen pages).
Arm Stay	Used to Arm the system in Stay mode (displayed on both Home Screen pages).
Settings	Provides access to various keypad functions (i.e.; Brightness, Contrast, Volume, Voice, Chime & Ringer).
Delay/Instant	Used to toggle between exit delay and instant arming options (displayed on both Home Screen pages).
Back	Returns system to first page of the Home Screen.

Installer Tools Menu

The Tools/Installer Menu provides access to the Installer configurable features and displays six options. Entering the Installer Code is required to access the Installer Menu.

Note: For information regarding the Rules, Events and Schedules programming screens, refer to the User Manual.

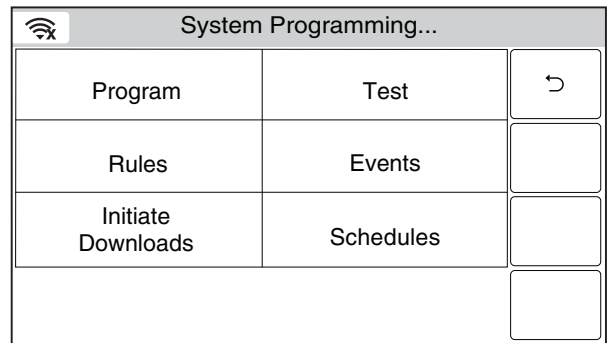

5200-100-092-V0

Installer Tools Menu Page

User Tools Menu

The User Menu provides access to the User configurable features and displays eight options. Entering the Master Code is required to access the User Menu.

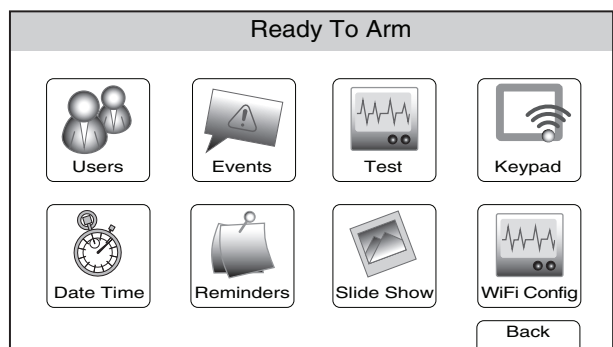

5100-100-006-V0

User Tools Menu Page

Mechanics of Programming

General Programming Information



When power cycling the control, remove AC power first and wait approximately 1 minute before disconnecting battery.

Programming options are stored in non-removable, electrically erasable, nonvolatile EEROM memory. The system can be programmed at any time, even at the installer's premises prior to the actual installation. Simply apply power temporarily to the Control and then program the unit as desired.

The "Initiate Download" button is used to initiate remote programming using an IBM PC compatible Personal Computer, and Compass Downloader and modem (L5210 only) or via capable GSM or IP communications modules (L5210 and L7000). See the *Remote Programming/Control (Downloading)* section for additional information.

Programming



If the system is Armed or in Alarm, the Tools icon will not be functional. The system must first be disarmed.

Enter Installer Programming Mode

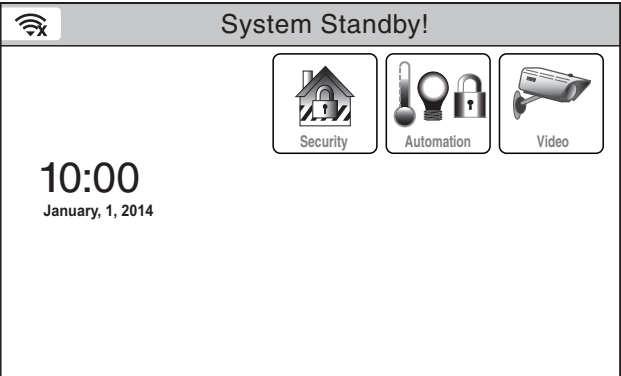
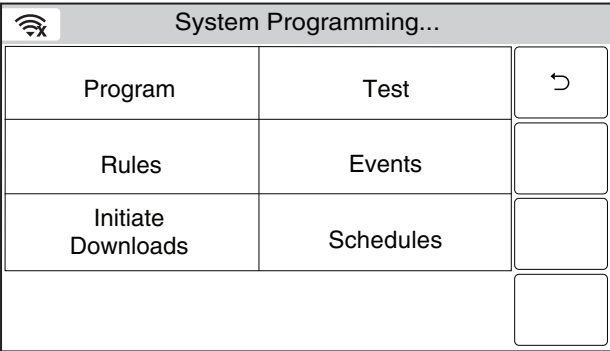
SCREEN	ACTION						
<div style="border: 1px solid black; padding: 5px; margin-bottom: 10px;">  <p style="text-align: center;">System Standby Screen</p> <p style="text-align: right; font-size: small;">7000-100-011-V1</p> </div> <div style="border: 1px solid black; padding: 5px;">  <p style="text-align: center;">Installer Tools Menu Screen</p> <p style="text-align: right; font-size: small;">5200-100-092-V0</p> </div>	<ol style="list-style-type: none"> 1. Power-up the control and allow it to "boot-up". "System Standby" is displayed on the touch screen. When the "boot-up" is complete (approximately 1-2 minutes) "Ready to Arm" is displayed. 2. Select the "Security" icon. 3. Select the "More" tab on the first page of the Security Screen. 4. Select "Tools" icon. 5. Enter the Installer Code 4112 on the displayed keypad. 6. The Installer Tools menu screen appears. Select the "Program" button. "System Programming..." is displayed and the "Panic" function key is lit red and the "Home" function key alternately flashes red and green. 7. Select one of the following options: <table border="0" style="width: 100%; border-collapse: collapse;"> <tr> <td style="border-right: 1px solid black; padding: 5px;"> Installer Code Date Time Zones Keys </td> <td style="padding: 5px;"> System Type Communicator Comm. Diagnostics Reporter </td> </tr> <tr> <td colspan="2" style="padding: 5px;"> Use the down ▼ arrow to scroll to the next page of options. </td> </tr> <tr> <td style="border-right: 1px solid black; padding: 5px;"> Sounder Default Config. Reset Master Code </td> <td style="padding: 5px;"> System Settings Language* Z-Wave </td> </tr> </table> 8. The system advances to the Programming screen of the selected option. <p>* This programming field may not be available with the system being installed.</p>	Installer Code Date Time Zones Keys	System Type Communicator Comm. Diagnostics Reporter	Use the down ▼ arrow to scroll to the next page of options.		Sounder Default Config. Reset Master Code	System Settings Language* Z-Wave
Installer Code Date Time Zones Keys	System Type Communicator Comm. Diagnostics Reporter						
Use the down ▼ arrow to scroll to the next page of options.							
Sounder Default Config. Reset Master Code	System Settings Language* Z-Wave						

Mechanics of Programming

Loading Factory Defaults

To load the factory defaults, enter the Installer Programming Mode and advance to second page of the System Programming and refer to following procedure. Refer to the Programming Default Values section of this manual to view the Default Values.



If a default configuration is loaded, any data that has already been programmed into the system will be changed according to the default configuration selected!

Select a Default Configuration

SCREEN			ACTION
System Programming...			1. Select "Default Configuration" to display the following options: Default Config 1 Default Config 2 Default Config 3 Default Config 4 Default Downloader Note: For a list of the pre-programmed defaults refer to the Default Values section. 2. Select the desired Default Configuration. 3. A Confirmation screen is displayed. 4. If "Yes" is selected, the System beeps three times and returns to the Default option screen. 5. If "No" is selected, the System returns to the Default option screen.
Sounder	System Settings	↶	
Default Config.	Language	△	
Reset Master Code	Z-Wave	□	
□			

Exiting Programming Mode

1. Select the "↶" key to exit the current screen. The system returns to the previous screen.
2. Select the "↶" key as required until system displays a Confirmation screen.
3. Select "Yes" to allow the installer to re-enter Programming mode or "No" to prevent re-entry.
4. Select the "↶" key again to return to the Security Screen OR depress the Home button to return to the Home Screen.

Zone Response Type Definitions

General Information

During programming, you must assign a zone type to each zone, which defines the way in which the system responds to faults in that zone. Zone types are defined below.

Type	Function	Characteristics
Not Used	Used to program a zone that is not used.	<ul style="list-style-type: none"> None
Entry/Exit 1 (Burglary)	Usually assigned to sensors or contacts on primary entry and exit doors.	<ul style="list-style-type: none"> Entry delay #1 is programmable. Exit delay is independently programmable. Exit and entry delays when armed in AWAY, STAY or NIGHT STAY mode. No entry delay when armed in STAY INSTANT or AWAY INSTANT mode. Exit delay regardless of the arming mode selected.
Entry/Exit 2 (Burglary)	Usually assigned to sensors or contacts on secondary entry and exit doors that might be further from the keypad (typically used for a garage, loading dock, or basement door).	<ul style="list-style-type: none"> Entry delay #2 is programmable. Exit delay is independently programmable. Secondary entry delay, if armed in the AWAY or STAY mode. No entry delay when armed in the STAY INSTANT or AWAY INSTANT mode. Exit delay begins regardless of the arming mode selected.
Perimeter (Burglary)	Usually assigned to all sensors or contacts on exterior doors and windows	<ul style="list-style-type: none"> Instant alarm, when armed in AWAY, STAY, STAY NO DELAY, NIGHT STAY or AWAY INSTANT mode.
Interior, Follower	Usually assigned to a zone covering an entry area (i.e.: foyer, lobby, or hallway) that one must pass upon entry (after faulting the entry/exit zone) to reach the keypad. It provides an instant alarm if the entry/exit zone is not violated first, and protects an area in the event an intruder has hidden on the premises before the system is armed, or gains access to the premises through an unprotected area.	<ul style="list-style-type: none"> Delayed alarm (using the programmed entry/exit time) if entry/exit (types 01 or 02) or interior-with-delay (type 10) zone is faulted first. Instant alarm in all other situations. Active when armed in AWAY or AWAY INSTANT mode. Bypassed automatically when armed in STAY, NIGHT STAY or STAY INSTANT mode.
Trouble by Day/ Alarm by Night	Usually assigned to a zone that covers a sensitive area (i.e.: stock room, drug supply room, etc.) It can also be used on a sensor or contact in an area where immediate notification of an entry is desired.	<ul style="list-style-type: none"> Instant alarm, when armed in AWAY, STAY, NIGHT STAY, STAY INSTANT, or AWAY INSTANT (night) mode. Provides a latched trouble sounding from the keypad and, if desired, a Central Station report when disarmed (day).
24-hour Silent Alarm	Usually assigned to a zone containing an Emergency button (silent emergency).	<ul style="list-style-type: none"> Sends a report to the Central Station but provides no keypad display or sounding. In disarmed state sends a report to the Central Station displays "Not Ready to Arm" on the keypad and "AWAY", "STAY" and "TOOLS" buttons are disabled.
24-hour Audible Alarm	Usually assigned to a zone containing an Emergency button (audible emergency).	<ul style="list-style-type: none"> Follows sounder timeout Sends a report to the Central Station, and provides alarm sounds at the keypad.
24-hour Auxiliary Alarm	Usually assigned to a zone containing a button for use in personal emergencies or to a zone containing monitoring devices (i.e.: water or temperature sensors, etc.).	<ul style="list-style-type: none"> Sends a report to the Central Station and provides an alarm sound at the keypad. (There is no keypad timeout.)
Interior with Delay	Provides entry delay (using the programmed entry time), if tripped when the panel is armed in the AWAY mode. Bypassed when the panel is armed in the STAY or STAY INSTANT mode.	<ul style="list-style-type: none"> Entry delay #1 (with programmed entry time) when armed in the AWAY mode. Entry delay begins whenever sensors in this zone are violated, regardless of whether an entry/exit delay zone was tripped first. No entry delay when armed in the AWAY INSTANT mode. Exit delay regardless of the arming mode selected.
Fire No Verification	Can be assigned to any wireless zone used as a fire zone. This zone type is always active and cannot be bypassed.	<ul style="list-style-type: none"> Alarm sound will pulse (Temporal Fire) when this zone type is alarmed.
Fire with Verification	Can be assigned to any wireless zone used as a fire zone. Fire with verification is available with smoke detector device type. It can not be used with heat detectors, combination heat/smoke detectors, wireless sensors or fire pull stations. This zone type is always active and cannot be bypassed.	<ul style="list-style-type: none"> Alarm sound will pulse (Temporal Fire) when this zone type is alarmed. Only after the alarm has been verified. System verifies alarm by delaying reporting and Control Panel alarm sounding for 30 seconds after alarm is detected. If the zone remains faulted after 30 seconds a fire alarm is provided. If any other fire zone is faulted during the 30 second delay window a fire alarm is immediately provided for that zone. An alarm for original fire zone will also be provided if that zone is still faulted afterward. If there are no fire alarms after the 30 second delay expires, the system will open a 60 second window. If any fire zone is faulted during that window a fire alarm will immediately be provided for that zone.
24-hour Carbon Monoxide Monitor	Can be assigned to any wireless zone with a carbon monoxide detector. This zone type is always active and cannot be bypassed.	<ul style="list-style-type: none"> Local keypad and detector will sound when this zone type is alarmed. (Pulse Temporal 4)

Zone Response Type Definitions

Type	Function	Characteristics
Arm–Stay	Special-purpose zone type used with 5800 Series wireless button units.	<ul style="list-style-type: none"> • Exit delay regardless of the arming mode selected. • System is armed in the STAY mode when the zone is activated.
Arm–Away	Special-purpose zone type used with 5800 Series wireless button units.	<ul style="list-style-type: none"> • System is armed in the AWAY mode when the zone is activated.
Disarm	Special-purpose zone type used with 5800 Series wireless button units.	<ul style="list-style-type: none"> • Disarms the system when the zone is activated.
No Alarm Response	Assigned when no-alarm response is required	<ul style="list-style-type: none"> • No reports to the Central Station. • No keypad sounding or chime • System can still be armed • No display on the screen
Silent Burglary	Usually assigned to sensors or contacts on exterior doors and windows where sirens are NOT desired.	<ul style="list-style-type: none"> • Instant alarm, with NO audible indication when armed in the AWAY, STAY, STAY NO DELAY, NIGHT STAY, or AWAY INSTANT mode. • Report sent to the Central Station.
Monitor	Can be assigned to any wireless zone used for asset protection. Works as a dynamic monitor of a zone fault/trouble (not alarm).	<ul style="list-style-type: none"> • Reports to the Central Station, if enabled. • Fault/restore events are logged by the system. • Activity Zone No. and Zone Descriptor displayed on LCD. • Restore will be stored in event log. • No keypad sounding or chime • System can still be armed
General Monitor	Assigned sensors or contacts on doors and windows or asset protection within the premises. Used to track activity of the occupant and alert occupant of the activity of others.	<ul style="list-style-type: none"> • No reports to the Central Station. • Fault/restore events are logged by the system. • Monitors entry into a monitored area. Activates a one-time announcement when faulted. • Activity Zone No. and Zone Descriptor displayed on LCD.
General Response	Assigned sensors or contacts on doors and windows or asset protection within the premises. Used to track activity of the occupant and alert occupant of the activity of others.	<ul style="list-style-type: none"> • No reports to the Central Station. • Fault/restore events are logged by the system. • Monitors entry into a monitored area. Activates a zone announcement when faulted. • Activity Zone No. and Zone Descriptor displayed on LCD. • System re-triggers audible sounding every ten seconds until acknowledged (Off sequence or wireless button).
Resident Monitor	Used to monitor a resident in an area deemed to be dangerous by a caregiver.	<ul style="list-style-type: none"> • No reports to the Central Station. • Monitors entry into a monitored area. Activates a zone announcement when faulted. • Activity Zone No. and Zone Descriptor displayed on LCD. • Fault/Restore events are not logged by the system.
Resident Response	Used to monitor a resident in an area deemed to be dangerous by a caregiver. Requires acknowledgement by caregiver.	<ul style="list-style-type: none"> • No reports to the Central Station. • Monitors entry into a monitored area. Activates a zone announcement when faulted. • Activity Zone No. and Zone Descriptor displayed on LCD. • System re-triggers audible sounding every ten seconds until acknowledged (Off sequence or wireless button). • Fault/Restore events are not logged by the system
Trouble	Used with Other response type	<ul style="list-style-type: none"> • The system will provide a trouble sounding from the keypad (and a Central Station report, if desired).
Garage (Burglary)	Assigned to Automatic Garage Door applications. Provides a status of the garage door close/open real time state	<ul style="list-style-type: none"> • Associated With Entry Delay #2 Programmed Time. • Exit delays when armed in AWAY, STAY or NIGHT STAY mode. • No Entry Delay when armed in Away or Stay Instant modes. • System can be armed with zone in the faulted state. When the zone is closed it will automatically be inclusive within protection points. If the point is subsequently violated, it will initiate an alarm.
Garage Monitor	Assigned to Automatic Garage Door applications. Provides a status of the garage door close/open real time state	<ul style="list-style-type: none"> • Can be assigned to any wireless zone used for automatic “Garage Door” Open/Close status. • Will not initiate an alarm condition on the control. • When zone is in the open state will display “FAULT.” • Does not report alarms to Central Station. • Zone will chime if enabled to do so • System can be armed if this zone type is in fault

Programming the Control

After entering the System Programming mode select from the options provided on the First and Second Installer Programming tools screens as shown in the accompanying figure.

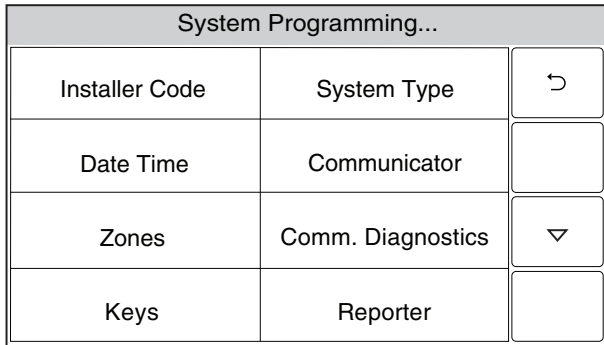

Page 1

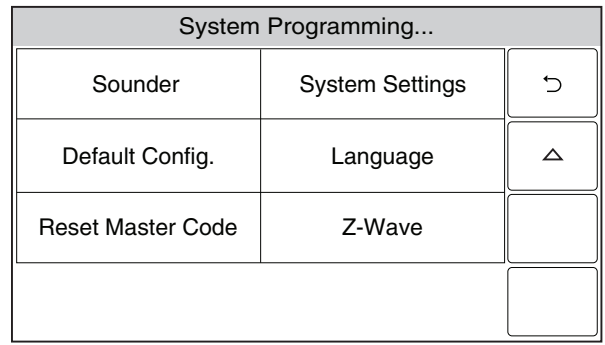

Page 2

Enter Installer Programming Mode without using Installer Code

SCREEN	ACTION
	<ol style="list-style-type: none"> 1. During the initial system power-up initialization delay (while "SYSTEM STANDBY!" is displayed), depress the Home key. Wait for system to terminate the system initialization delay. 2. Select the "Security" icon. 3. Select the "Arm Stay" icon. 4. Press the "Clear" key on the displayed keypad. A blue vertical bar is displayed below the "Enter Code". 5. Enter "00" on the keypad. The system will enter Installer Programming mode and the Installer Tools Menu will be displayed.

Change Installer Code

The factory default Installer Code for the LYNX Touch Control is set to 4-1-1-2.

SCREEN	ACTION
	<ol style="list-style-type: none"> 1. Select "Installer Code". The current four-digit Installer Code is displayed on the left side of the screen. 2. Select the "Clear" button, then enter a new four-digit Installer Code on the displayed keypad. The system will display the new code on the left side of the screen. 3. Select "Done" when you are finished. 4. The system returns to the "System Programming" Screen.

Select a Language

Note: This programming field may not be available with the system being installed.

SCREEN	ACTION
	<ol style="list-style-type: none"> 1. If applicable, select "Language" to display the following options: Installer Language User Language 2. Select "Installer Language. The system toggles between "English" and "French". 3. Select the desired language. 4. Select "User Language. The system toggles between "English" and "French". 5. Select the desired language. 6. Select "Save" when you are finished. 7. A confirmation screen appears. If "Yes" is selected, the System returns to the second page of the Programming screen, which will be displayed in the selected language.

Programming the Control System Type

The following system options are programmed in this section:

Option	Function
RF Jam	Enable or disable RF Jam Log and Reporting
Speaker Phone	Enable or disable Speaker Phone mode. (Only available on the LYNX Touch L5210/L5210CN)
Two Way Voice	Enable or disable Two Way Voice communication with the Central Station.
RF House Code	Set RF House Code. (Bi-directional RF Devices)
Remote Phone	Enable or disable Remote Phone Control mode. (Only available on the LYNX Touch L5210/L5210CN)
Phone Notification	Enable or disable Phone Notification mode. (Phone Line-cut) (Only available on the LYNX Touch L5210/ L5210CN)
Phone Detect Time	Select a delay period between phone line-cut & system response (allows phone to restore) (Only available on the LYNX Touch L5210/ L5210CN) Note: This field is displayed if Phone Notification is enabled.
Events	Enable or disable multiple options for event logging (i.e.; alarms, troubles, open/close, bypass, all)
Non-Security	Enable or disable non-security event logging
Remote Access Serial	Enable or disable end user to access their system via a website
Multi Mode Serial	Enable or disable transmission of panel status events via email (Active only when Remote Access Serial is enabled)

Note: If applicable, preprogrammed defaults for the L5210/L7000 Control are shown on the screen unless otherwise noted.

Screen	ACTION																
<div style="border: 1px solid black; padding: 5px; width: fit-content;"> System Type <small>5000-100-130-V0</small> </div>	<p>System Type Note: If applicable, the pre-programmed default will be displayed beneath the option.</p> <ol style="list-style-type: none"> Select "System Type" from the following options: <table style="margin-left: 40px; border-collapse: collapse;"> <tr> <td style="padding-right: 20px;">RF Jam</td> <td>Speaker Phone</td> </tr> <tr> <td>Two Way Voice</td> <td>RF House Code</td> </tr> <tr> <td>Phone Notification</td> <td>Remote Phone</td> </tr> <tr> <td>Phone Detect Time</td> <td></td> </tr> </table> <p>Use the down ▼ arrow to scroll to the next page of options.</p> <table style="margin-left: 40px; border-collapse: collapse;"> <tr> <td style="padding-right: 20px;">Events – Log All</td> <td>Events – Log Alarm</td> </tr> <tr> <td>Events – Log Bypass</td> <td>Events – Log Open/Close</td> </tr> <tr> <td>Events – Log Trouble</td> <td>Non Security</td> </tr> <tr> <td>Remote Access Serial</td> <td>Multi Mode Serial</td> </tr> </table> 	RF Jam	Speaker Phone	Two Way Voice	RF House Code	Phone Notification	Remote Phone	Phone Detect Time		Events – Log All	Events – Log Alarm	Events – Log Bypass	Events – Log Open/Close	Events – Log Trouble	Non Security	Remote Access Serial	Multi Mode Serial
RF Jam	Speaker Phone																
Two Way Voice	RF House Code																
Phone Notification	Remote Phone																
Phone Detect Time																	
Events – Log All	Events – Log Alarm																
Events – Log Bypass	Events – Log Open/Close																
Events – Log Trouble	Non Security																
Remote Access Serial	Multi Mode Serial																
<div style="border: 1px solid black; padding: 5px; width: fit-content;"> RF Jam Disabled </div>	<ol style="list-style-type: none"> Select "RF Jam". The System scrolls between the following: Disabled RF Jam Log RF Jam Log & Report 																
<div style="border: 1px solid black; padding: 5px; width: fit-content;"> Speaker Phone Disabled </div>	<p>Note: The Speaker Phone field is not available on the LYNX Touch L7000/L7000CN.</p> <ol style="list-style-type: none"> Select "Speaker Phone". The System toggles between the following: Disabled Enabled 																
<div style="border: 1px solid black; padding: 5px; width: fit-content;"> Two Way Voice Disabled </div>	<ol style="list-style-type: none"> Select "Two-Way Voice". The System toggles between the following: Disabled Enabled 																
<div style="border: 1px solid black; padding: 5px; width: fit-content;"> RF House Code 0 </div>	<ol style="list-style-type: none"> Select "RF House Code". After entering a code (00-31) on the displayed keypad, select "Done". 																
<div style="border: 1px solid black; padding: 5px; width: fit-content;"> Remote Phone Enabled </div>	<p>Note: The Remote Phone field is not available on the LYNX Touch L7000/L7000CN.</p> <ol style="list-style-type: none"> Select "Remote Phone". The System toggles between the following options: Disabled Enabled 																

Programming the Control



System Type (Continued)

Screen	ACTION
<p>Phone Notification Disabled</p>	<p>Note: The Phone Notification field is not available on the LYNX Touch L7000/L7000CN. 8. Select "Phone Notification" (phone line cut). The System scrolls between the following options: Disabled Keypad Trouble If "Keypad" or "Trouble" is selected proceed to Step 8.</p>
<p>Phone Detect Time 2 Minutes</p>	<p>Note: The Phone Detect Time field is not available on the LYNX Touch L7000/L7000CN. 9. If Keypad or Trouble was selected in Step 7, the "Phone Detect Time" option is displayed. Select "Phone Detect Time". The system scrolls between the following options: 1 Minute 2 Minutes 3 Minutes 4 Minutes</p>
<p>Events - Log All Log All Set</p>	<p>Use the down ▼ arrow to scroll to the next page of options. 10. Select "Events - Log All". The system displays "Press To Log All". Selecting this option programs the system to log all events and "Log All Set" is displayed. Additionally all of the options listed below are enabled. Events – Log Alarm Events – Log Bypass Events – Log Open/Close Events – Log Trouble Non-Security OR Proceed to step 11 and select the options individually.</p>
<p>Events – Log Alarm Enabled</p>	<p>11. Select "Events – Log Alarm". The System toggles between "Enabled" and "Disabled". 12. Select "Events – Log Bypass". The System toggles between "Enabled" and "Disabled". 13. Select "Events – Log Open/Close". The System toggles between "Enabled" and "Disabled". 14. Select "Events – Log Trouble". The System toggles between "Enabled" and "Disabled".</p>
<p>Non Security Enabled</p>	<p>15. Select "Non Security". The System toggles between "Enabled" and "Disabled".</p>
<p>Remote Access Serial Disabled</p>	<p>16. Select "Remote Access Serial". The System toggles between "Enabled" and "Disabled". If the Remote Access Serial" option is enabled, the "Multi Mode Serial" option is displayed.</p>
<p>Multi Mode Serial Disabled</p>	<p>Note: The Multi Mode Serial field is "Disabled" unless the Remote Access Serial field has been set to "Enabled". 17. Select "Multi Mode Serial". The System toggles between "Enhanced Reports" and "Disabled". 18. Select "Save" when complete.</p>

Programming the Control

Program Date and Time

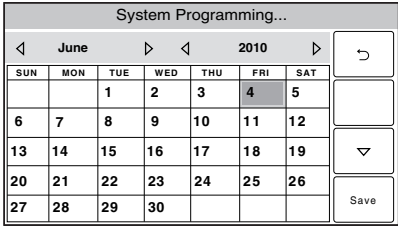
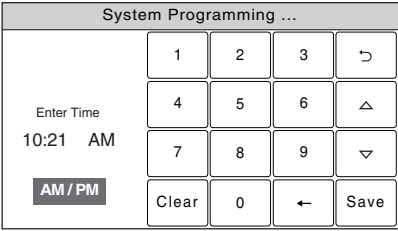
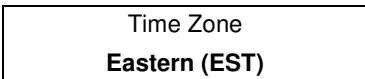
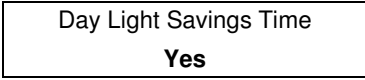
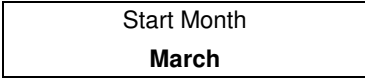
Note: If applicable, preprogrammed defaults for the L5210/L7000 Control are shown on the screen unless otherwise noted.

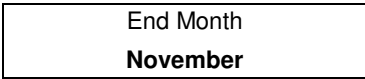
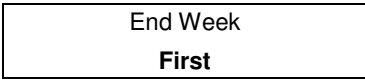
SCREEN	ACTION																																										
 <p style="text-align: center;">Date Time</p> <p style="text-align: right; font-size: small;">5000-100-131-V0</p>	<p>Note: If you are installing a 4GL/4GLC or 3GL/3GLC, L5100-WiFi or ILP5 Communication Module, the time and date will be programmed and updated automatically via Central Station. You must still program the correct Time Zone below.</p> <ol style="list-style-type: none"> 1. Select "Date Time". 																																										
 <p style="text-align: center;">System Programming...</p> <p style="text-align: center;">June 2010</p> <table border="1" style="width: 100%; text-align: center; font-size: x-small;"> <tr> <td>SUN</td><td>MON</td><td>TUE</td><td>WED</td><td>THU</td><td>FRI</td><td>SAT</td> </tr> <tr> <td></td><td></td><td>1</td><td>2</td><td>3</td><td>4</td><td>5</td> </tr> <tr> <td>6</td><td>7</td><td>8</td><td>9</td><td>10</td><td>11</td><td>12</td> </tr> <tr> <td>13</td><td>14</td><td>15</td><td>16</td><td>17</td><td>18</td><td>19</td> </tr> <tr> <td>20</td><td>21</td><td>22</td><td>23</td><td>24</td><td>25</td><td>26</td> </tr> <tr> <td>27</td><td>28</td><td>29</td><td>30</td><td></td><td></td><td></td> </tr> </table> <p style="text-align: right; font-size: x-small;">5000-100-016-V0</p>	SUN	MON	TUE	WED	THU	FRI	SAT			1	2	3	4	5	6	7	8	9	10	11	12	13	14	15	16	17	18	19	20	21	22	23	24	25	26	27	28	29	30				<ol style="list-style-type: none"> 2. Using the left ◀ and right ▶ arrows select the Month and Year then select the date. Select the ▼ key to advance to the next screen.
SUN	MON	TUE	WED	THU	FRI	SAT																																					
		1	2	3	4	5																																					
6	7	8	9	10	11	12																																					
13	14	15	16	17	18	19																																					
20	21	22	23	24	25	26																																					
27	28	29	30																																								
 <p style="text-align: center;">System Programming ...</p> <p style="text-align: center;">Enter Time</p> <p style="text-align: center;">10:21 AM</p> <p style="text-align: center;">AM / PM</p> <table border="1" style="width: 100%; text-align: center; font-size: x-small;"> <tr> <td>1</td><td>2</td><td>3</td><td>↩</td> </tr> <tr> <td>4</td><td>5</td><td>6</td><td>⬆</td> </tr> <tr> <td>7</td><td>8</td><td>9</td><td>⬇</td> </tr> <tr> <td>Clear</td><td>0</td><td>←</td><td>Save</td> </tr> </table> <p style="text-align: right; font-size: x-small;">5000-100-019-V0</p>	1	2	3	↩	4	5	6	⬆	7	8	9	⬇	Clear	0	←	Save	<ol style="list-style-type: none"> 3. To set the correct time, touch the "Clear" button. 4. Enter the correct time and then select AM or PM. Select the ▼ key to advance to the next screen or select "Save" to return to the System Programming Screen. 																										
1	2	3	↩																																								
4	5	6	⬆																																								
7	8	9	⬇																																								
Clear	0	←	Save																																								
 <p style="text-align: center;">Time Zone</p> <p style="text-align: center;">Eastern (EST)</p>	<ol style="list-style-type: none"> 6. Select "Time Zone". The system scrolls between the following options: <table border="1" style="width: 100%; text-align: center; font-size: x-small;"> <tr> <td>Eastern (EST)</td> <td>Pacific (PST)</td> <td>Atlantic (AST)</td> </tr> <tr> <td>Central (CST)</td> <td>Alaska (AKST)</td> <td>Newfoundland (NT)</td> </tr> <tr> <td>Hawaii (HAST)</td> <td>Brasilia (BRT)</td> <td></td> </tr> <tr> <td>Mountain (MST)</td> <td>Mid-Atlantic (MAT)</td> <td></td> </tr> </table> 	Eastern (EST)	Pacific (PST)	Atlantic (AST)	Central (CST)	Alaska (AKST)	Newfoundland (NT)	Hawaii (HAST)	Brasilia (BRT)		Mountain (MST)	Mid-Atlantic (MAT)																															
Eastern (EST)	Pacific (PST)	Atlantic (AST)																																									
Central (CST)	Alaska (AKST)	Newfoundland (NT)																																									
Hawaii (HAST)	Brasilia (BRT)																																										
Mountain (MST)	Mid-Atlantic (MAT)																																										
 <p style="text-align: center;">Day Light Savings Time</p> <p style="text-align: center;">Yes</p>	<ol style="list-style-type: none"> 7. Select "Day Light Savings Time". The system toggles between "Yes" and "No". If "Yes" is selected the following options will become active. 																																										
 <p style="text-align: center;">Start Month</p> <p style="text-align: center;">March</p>	<ol style="list-style-type: none"> 8. Select "Start Month". The system displays the following options. <table border="1" style="width: 100%; text-align: center; font-size: x-small;"> <tr> <td>January</td> <td>February</td> </tr> <tr> <td>March</td> <td>April</td> </tr> <tr> <td>May</td> <td>June</td> </tr> <tr> <td>July</td> <td>August</td> </tr> <tr> <td>September</td> <td>October</td> </tr> <tr> <td>November</td> <td>December</td> </tr> </table> <p>Use the down ▼ arrow to scroll to the next page of options.</p> 	January	February	March	April	May	June	July	August	September	October	November	December																														
January	February																																										
March	April																																										
May	June																																										
July	August																																										
September	October																																										
November	December																																										
 <p style="text-align: center;">Start Week</p> <p style="text-align: center;">Second</p>	<ol style="list-style-type: none"> 9. Select "Start Week". The system scrolls between the following options. <table border="1" style="width: 100%; text-align: center; font-size: x-small;"> <tr> <td>First</td> <td>Fourth</td> <td>3rd from Last</td> </tr> <tr> <td>Second</td> <td>Last</td> <td></td> </tr> <tr> <td>Third</td> <td>Next to Last</td> <td></td> </tr> </table> 	First	Fourth	3rd from Last	Second	Last		Third	Next to Last																																		
First	Fourth	3rd from Last																																									
Second	Last																																										
Third	Next to Last																																										
 <p style="text-align: center;">End Month</p> <p style="text-align: center;">November</p>	<ol style="list-style-type: none"> 10. Select "End Month". The system displays the following options. <table border="1" style="width: 100%; text-align: center; font-size: x-small;"> <tr> <td>January</td> <td>February</td> </tr> <tr> <td>March</td> <td>April</td> </tr> <tr> <td>May</td> <td>June</td> </tr> <tr> <td>July</td> <td>August</td> </tr> <tr> <td>September</td> <td>October</td> </tr> <tr> <td>November</td> <td>December</td> </tr> </table> <p>Use the down ▼ arrow to scroll to the next page of options.</p> 	January	February	March	April	May	June	July	August	September	October	November	December																														
January	February																																										
March	April																																										
May	June																																										
July	August																																										
September	October																																										
November	December																																										
 <p style="text-align: center;">End Week</p> <p style="text-align: center;">First</p>	<ol style="list-style-type: none"> 11. Select "End Week". The system will scrolls through the available weeks. <table border="1" style="width: 100%; text-align: center; font-size: x-small;"> <tr> <td>First</td> <td>Fourth</td> <td>3rd from Last</td> </tr> <tr> <td>Second</td> <td>Last</td> <td></td> </tr> <tr> <td>Third</td> <td>Next to Last</td> <td></td> </tr> </table> 12. After programming these options, select the "Save" key. 	First	Fourth	3rd from Last	Second	Last		Third	Next to Last																																		
First	Fourth	3rd from Last																																									
Second	Last																																										
Third	Next to Last																																										

Programming the Control

Program the Communications Module



A router is required if you are installing the L5100-WiFi module. The router must be powered on and connected for WiFi operation (alarm reporting) to occur.

The following system options are programmed in this section:

Option	Function
Communications Path	Selects type of Communications Module
APL	Enables Advanced Protection Logic
City ID	Enter Central Station Primary City ID
CS ID	Enter Primary Central Station ID
Sub ID	Enter Central Station Primary Subscriber ID
Supervision	Selects how often the Communications Module sends supervisory messages to the Central Sta.
Old Alarm Time	Selects how long an undeliverable alarm delivery is retried to the Central Station.
Remote Acc. Comm.	Enables or disables user remote access via internet and/or GSM.
Multi Mode Comm.	(appears only if Remote Access IP or GSM is enabled.) Enables or disables multi mode feature.
IP Fault Time	(Appears only if IP or WiFi is enabled in Communications Path field.) Selects time delay before the Communications Module notifies the Control Panel of a loss of contact with the internet.
Use DHCP	Dynamically selects the IP addresses
NIC IP Address	(Appears only if "No" is selected in Use DHCP field.) Enter NIC IP Address.
Subnet Mask	(Appears only if "No" is selected in Use DHCP field.) Enter Subnet Address.
Gateway IP Address	(Appears only if "No" is selected in Use DHCP field.) Enter Gateway IP Address
DNS Server IP Address	(Appears only if "No" is selected in Use DHCP field.) Enter Domain Name Server IP Address.
GSM Fault Time	(Appears only if GSM is enabled in Communications Path field.) Selects time delay before the Communications Module notifies the Control Panel of a loss of contact with the network.
GSM Rollover	Allows messages to be sent over GSM in the event that contact with the internet is lost. (Appears only if "WiFi & GSM" is selected as the Communications Path.)
GSM 24 Hour Test	Enables daily test of GSM module operation. (Appears only if "WiFi & GSM" is selected as the Communications Path.)

Note: If applicable, preprogrammed defaults for the L5210/L7000 Control are shown on the screen unless otherwise noted.



Remote Access (Total Connect) and Multi Mode (PSD) over WiFi, IP or GSM cannot be enabled in the panel alone. Availability of this service is controlled via the web-based programming tool on the AlarmNet Direct website. These features must be enabled through the AlarmNet Direct website first and transferred to the device.

SCREEN	ACTION												
<div style="border: 1px solid black; padding: 5px; text-align: center;"> Communicator <small>5000-100-132-VO</small> </div>	<p>Communicator</p> <ol style="list-style-type: none"> Select "Communicator". The System displays several pages of options that vary depending upon the selections that are made. Use the down ▼ arrow to scroll through the pages of options. <table style="width: 100%; border-collapse: collapse;"> <tr> <td style="width: 50%; text-align: center;">Communications Path</td> <td style="width: 50%; text-align: center;">APL</td> </tr> <tr> <td style="text-align: center;">City ID</td> <td style="text-align: center;">Sub ID</td> </tr> <tr> <td style="text-align: center;">Supervision</td> <td style="text-align: center;">Old Alarm Time</td> </tr> <tr> <td style="text-align: center;">Remote Acc. Comm.</td> <td style="text-align: center;">Multi Mode Comm.</td> </tr> <tr> <td style="text-align: center;">IP Fault Time</td> <td style="text-align: center;">Use DHCP</td> </tr> <tr> <td style="text-align: center;">GSM Fault Time</td> <td></td> </tr> </table>	Communications Path	APL	City ID	Sub ID	Supervision	Old Alarm Time	Remote Acc. Comm.	Multi Mode Comm.	IP Fault Time	Use DHCP	GSM Fault Time	
Communications Path	APL												
City ID	Sub ID												
Supervision	Old Alarm Time												
Remote Acc. Comm.	Multi Mode Comm.												
IP Fault Time	Use DHCP												
GSM Fault Time													
<div style="border: 1px solid black; padding: 5px; text-align: center;"> Communications Path None </div>	<ol style="list-style-type: none"> Select "Communications Path". The system scrolls between the following options. <p>Notes: The available options are dependent upon which communications module(s) has been installed. If Communication Path is set to GSM, the control will report to AlarmNet over GSM/GPRS not WiFi.</p> <table style="width: 100%; border-collapse: collapse;"> <tr> <td style="width: 50%;">None</td> <td style="width: 50%;">WiFi</td> </tr> <tr> <td>IP</td> <td>WiFi & GSM</td> </tr> <tr> <td>GSM</td> <td></td> </tr> </table>	None	WiFi	IP	WiFi & GSM	GSM							
None	WiFi												
IP	WiFi & GSM												
GSM													
<div style="border: 1px solid black; padding: 5px; text-align: center;"> APL Disabled </div>	<ol style="list-style-type: none"> Select "APL". The system scrolls between "Enabled" and "Disabled". <p>Note: If APL is used, GSM or IP must be selected as the Primary Communicator Type in the Reporter programming.</p>												

Programming the Control

Program the Communications Module (Continued)

SCREEN	ACTION
City ID	4. Select "City ID". Enter the 2-digit Primary City ID (Decimal). Options 01-99
CS ID	5. Select "CS ID". Enter the 2-digit Primary Central Station ID (HEX). Options 01-FE
Sub ID	6. Select "Sub ID". Enter the 4-digit Subscriber Account Number (Decimal). Options 0001-9999
Supervision 24 Hours	7. Select "Supervision". The system scrolls between the following options: 24 Hours None 30 Days
Old Alarm Time 10 Minutes	8. Select "Old Alarm Time". The system scrolls between the following options. Use the down ▼ arrow to scroll to the next page of options. 10 Minutes 15 Minutes 30 Minutes 1 Hour 2 Hours 4 Hours 8 Hours 12 Hours 24 Hours
Remote Acc. Comm. Disabled	9. Select "Remote Acc. Comm.". The system toggles between "Disabled" and "Enabled". Note: This field will not be programmable unless it is enabled when creating the Communications Module account in AlarmNet.
Multi Mode Comm. Disabled	10. If "Remote Acc. Comm." was enabled in the previous step, the "Multi Mode Comm." option is displayed. The system scrolls between the following options. Disabled Relay Reports Enhanced Reports Note: This field will not be programmable unless it is enabled when creating the Communications Module account in AlarmNet. The Relay Reports option should not be selected when using TotalConnect 2.1 Service. 11. Use the down ▼ arrow to scroll to the next page of options. If IP was selected in step 2, proceed to step 12. If GSM was selected in step 2, proceed to step 19.
IP Fault Time (min) 00	12. Select "IP Fault Time (min)". Enter the time delay (in minutes) on the keypad. Options 00-99
Use DHCP Yes	13. Select "Use DHCP". The system toggles between "Yes" and "No". If "No" is selected the system displays four additional options. If "Yes" is selected, skip to step 18.
NIC IP Address 255.255.255.255	14. Select "NIC IP Address". Enter the 4-part address on the displayed keypad.
Subnet Mask 255.255.255.255	15. Select "Subnet Mask". Enter the 4-part address on the displayed keypad.
Gateway IP Address 255.255.255.255	16. Select "Gateway IP Address". Enter the 4-part address on the displayed keypad.
DNS Server IP Address 255.255.255.255	17. Select "DNS Server IP Address". Enter the 4-part address on the displayed keypad. 18. If "IP" was selected in step 2, select "Save" and then select "OK" when the "Programming Done" screen appears. Proceed to "Diagnostics" section in order to register the device.

Programming the Control

Program the Communications Module (Continued)

<p>GSM Fault Time (min) 00</p>	<p>19. Select "GSM Fault Time (min)". Enter the time delay (in minutes) on the keypad. Options 00-99</p>
<p>GSM Rollover No</p>	<p>20. If "WiFi and GSM" was selected in step 2, two additional programming fields are displayed. Select "GSM Rollover", the system toggles between "Yes" and "No".</p>
<p>GSM 24 Hour Test No</p>	<p>21. Select "GSM 24 Hour Test", the system toggles between "Yes" and "No". 22. If "GSM" was selected in step 2, select "Save" and then select "OK" when the "Programming Done" screen appears. Proceed to "Diagnostics" section in order to register the device.</p>

Programming the Control

Program the Z-Wave Module

The following system options are programmed in this section:

Option	Function
Z-Wave	Enables or disables the Z-Wave Module
Temperature Display	Toggles between Fahrenheit and Celsius (for Z-Wave compatible Thermostats)

Note: If applicable, preprogrammed defaults for the L5210/L7000 Control are shown on the screen unless otherwise noted.

SCREEN	ACTION
<div style="border: 1px solid black; padding: 10px; text-align: center;"> <p>Z - Wave</p> <p style="font-size: small; margin-top: 10px;">5100-100-067-V0</p> </div>	<ol style="list-style-type: none"> 1. Enter Program Mode and default the panel (Refer to "Loading Factory Defaults"). 2. Select "Z-Wave" The System displays the following options: <div style="text-align: center; margin-left: 40px;"> Z-Wave Temperature Display </div>
<div style="border: 1px solid black; padding: 10px; text-align: center;"> <p>Z-Wave Enabled-Installed Telephone</p> </div>	<ol style="list-style-type: none"> 3. Select "Z-Wave". The system toggles between the following options: Enabled – Installed Telephone Side Disabled Select "Enabled – Installed Telephone Side".
<div style="border: 1px solid black; padding: 10px; text-align: center;"> <p>Temperature Display Fahrenheit</p> </div>	<ol style="list-style-type: none"> 4. If you wish to change the temperature format, select "Temperature Display". The system toggles between the following options: Fahrenheit Celsius 5. Select "Save". 6. Select the "↵" key to return to the previous screen or the Home button to return to the Home screen. 7. Include Z-Wave devices. (Refer to Including/Excluding Z-Wave Devices in the Home Automation Guide P/N 800-19979 or higher.)

Programming the Control

Program Zones

The following system options are programmed in this section:

Option	Function
Serial Number	Manually enter device serial number or enroll via RF transmission
Loop Number	Manually enter device loop number or enroll via RF transmission
Zone Description 1/2	Enter Zone Descriptors for the device being enrolled
Device Type	Select the type of device being enrolled
Response Type	Select the alarm response for the device being enrolled (refer to Zone Response Type Table)
Alarm Report	Activate reporting option for the device being enrolled
Chime	Enable/disable chime mode for specific device being enrolled (applies to Entry/ Exit, Perimeter, and Interior Response types only)
Supervision	Select supervision for device being enrolled
Arm Night	Allows specific programmed motion sensors to be active when Arm Night mode is enabled and the system is Armed in Stay mode by the User.

Note: If applicable, preprogrammed defaults for the L5210/L7000 Control are shown on the screen unless otherwise noted.

SCREEN	ACTION																		
<div style="border: 1px solid black; padding: 5px; width: fit-content;">Zones</div> <p style="font-size: small; margin-top: 5px;">5000-100-133-V0</p>	<ol style="list-style-type: none"> Select "Zones" The System displays the following options: <table style="width: 100%; border-collapse: collapse;"> <tr> <td style="width: 50%;">1. New</td> <td style="width: 50%;">2. Front Door</td> </tr> <tr> <td>3. Back Door</td> <td>4. Window</td> </tr> <tr> <td>5. Motion Sensor</td> <td>6. New</td> </tr> </table> Use the down ▼ arrow to scroll to the next page of options. Use the ▲ arrow to return to the previous page. 7. – 45. New 46. – 48. New (Main) (reserved for Garage Door Zones) 49. – 64. New 140. – 147. 4 Button 148. – 155. New (Button Zones) 180. – 185. Temperature (Z-Wave Thermostat zones) (L5210 only) 180. – 187. Temperature (Z-Wave Thermostat zones) (L7000 only) 95. Fire 96. Medical 99. Police Select a zone and then select "Edit" or "Add New" to program the next available zone. The following options are displayed (dependant upon Zone Type): <table style="width: 100%; border-collapse: collapse;"> <tr> <td style="width: 33%;">Serial Number *</td> <td style="width: 33%;">Loop Number *</td> <td style="width: 33%;">* This field does not apply to Hardwire Zone 1 or Temperature Zones 80-85.</td> </tr> <tr> <td>Zone Description 1</td> <td>Zone Description 2</td> <td></td> </tr> <tr> <td>Device Type</td> <td>Response Type</td> <td></td> </tr> <tr> <td>Alarm Report</td> <td>Chime</td> <td>Supervision</td> </tr> </table> Select an option to display the next programming field. 	1. New	2. Front Door	3. Back Door	4. Window	5. Motion Sensor	6. New	Serial Number *	Loop Number *	* This field does not apply to Hardwire Zone 1 or Temperature Zones 80-85.	Zone Description 1	Zone Description 2		Device Type	Response Type		Alarm Report	Chime	Supervision
1. New	2. Front Door																		
3. Back Door	4. Window																		
5. Motion Sensor	6. New																		
Serial Number *	Loop Number *	* This field does not apply to Hardwire Zone 1 or Temperature Zones 80-85.																	
Zone Description 1	Zone Description 2																		
Device Type	Response Type																		
Alarm Report	Chime	Supervision																	
<div style="border: 1px solid black; padding: 5px; width: fit-content;">Serial Number</div>	<p>Serial Number (This field does not apply to Temperature Zones 80-85) When "Serial Number" has been selected "Enter Serial Number or Activate" is displayed. The transmitter serial number and loop number can be enrolled via RF transmission OR manually.</p> <p>Enroll via RF Learning To enroll the device using RF Learning mode three transmissions (open/close) of the device will be required. The initial transmission activates the RF Learning mode and the system will emit a single beep. A second transmission enrolls the serial number and the system beeps two times and displays "Activate Sensor Again To Confirm". A third transmission will confirm the serial number. The system beeps two times and returns to the Zone programming Screen.</p> <p>Enroll Manually Enter the 7-digit serial number printed on the transmitter using the displayed keypad and select "Done". The system beeps one time and returns to the Zone programming Screen.</p>																		
<div style="border: 1px solid black; padding: 5px; width: fit-content;">Loop Number 1</div>	<p>Loop Number (This field does not apply to Temperature Zones 80-85) Select "Loop Number" to toggle between 1, 2, 3 and 4. Enter Save.</p>																		

Programming the Control Program Zones (Continued)

SCREEN	ACTION																										
<p>Zone Description 1</p>	<p>Zone Description 1/Zone Description 2</p> <p>When programming the Zone Description, after entering the first letter of the description on the keypad you can use the up ▲ and down ▼ arrows to scroll through the available preprogrammed zone descriptions. For a list of the pre-programmed Zone Descriptors, please visit http://www.security.honeywell.com/hsc/resources/MyWebTech</p> <p>Select "Zone Description 1 or Zone Description 2". Using the displayed keypad enter Zone Description 1 or Zone Description 2. The system announces the Zone Description. Enter "Done", when you are finished. The system returns to the Zone Programming page.</p>																										
<p>Device Type</p>	<p>Device Type</p> <p>Select "Device Type". The system displays the following options:</p> <table border="0" style="width: 100%;"> <tr> <td style="width: 50%;">New</td> <td style="width: 50%;">Door</td> </tr> <tr> <td>Window</td> <td>Motion Sensor</td> </tr> <tr> <td>Glass Break</td> <td>Smoke Detector</td> </tr> <tr> <td>Heat Sensor</td> <td>Carbon Mono. Det.</td> </tr> </table> <p>Use the down ▼ arrow to scroll to the next page of options:</p> <table border="0" style="width: 100%;"> <tr> <td style="width: 50%;">Temperature</td> <td style="width: 50%;">Flood</td> </tr> <tr> <td>Environmental</td> <td>Medical</td> </tr> <tr> <td>Fire</td> <td>Police</td> </tr> <tr> <td>Garage Door</td> <td>Other</td> </tr> </table>	New	Door	Window	Motion Sensor	Glass Break	Smoke Detector	Heat Sensor	Carbon Mono. Det.	Temperature	Flood	Environmental	Medical	Fire	Police	Garage Door	Other										
New	Door																										
Window	Motion Sensor																										
Glass Break	Smoke Detector																										
Heat Sensor	Carbon Mono. Det.																										
Temperature	Flood																										
Environmental	Medical																										
Fire	Police																										
Garage Door	Other																										
<p>Response Type</p> <p>Not Used</p>	<p>Response Type</p> <p>1. Select "Response Type". The system displays the specific options, which are dependant upon the Device Type that was selected for the zone. Use the down ▼ arrow to scroll to the next page of options. Use the ▲ arrow to return to the previous page.</p> <table border="0" style="width: 100%;"> <tr> <td style="width: 50%;">Not Used</td> <td style="width: 50%;">Entry Exit 1</td> </tr> <tr> <td>Entry Exit 2</td> <td>Perimeter</td> </tr> <tr> <td>Interior Follower</td> <td>Trouble</td> </tr> <tr> <td>24 Hour Silent</td> <td>24 Hour Audible</td> </tr> <tr> <td>24 Hour Auxiliary</td> <td>Fire No Verification</td> </tr> <tr> <td>Interior With Delay</td> <td>Monitor</td> </tr> <tr> <td>Carbon Monoxide</td> <td>Garage</td> </tr> <tr> <td>Arm Stay</td> <td>Arm Away</td> </tr> <tr> <td>Disarm</td> <td>No Response</td> </tr> <tr> <td>Silent Burglary</td> <td>Resident Monitor</td> </tr> <tr> <td>Resident Response</td> <td>General Monitor</td> </tr> <tr> <td>General Response</td> <td>Fire With Verification</td> </tr> <tr> <td>Day/Night</td> <td>Garage Monitor</td> </tr> </table> <p>2. Select the desired Response Type and select "Save". The system will return to the Zone screen.</p> <p>Note: For threshold monitoring to be configurable on the LYNX Touch Z-wave thermostat screen, the respective zones will first need to be assigned with a response type in zone programming. The recommended response type is Trouble.</p>	Not Used	Entry Exit 1	Entry Exit 2	Perimeter	Interior Follower	Trouble	24 Hour Silent	24 Hour Audible	24 Hour Auxiliary	Fire No Verification	Interior With Delay	Monitor	Carbon Monoxide	Garage	Arm Stay	Arm Away	Disarm	No Response	Silent Burglary	Resident Monitor	Resident Response	General Monitor	General Response	Fire With Verification	Day/Night	Garage Monitor
Not Used	Entry Exit 1																										
Entry Exit 2	Perimeter																										
Interior Follower	Trouble																										
24 Hour Silent	24 Hour Audible																										
24 Hour Auxiliary	Fire No Verification																										
Interior With Delay	Monitor																										
Carbon Monoxide	Garage																										
Arm Stay	Arm Away																										
Disarm	No Response																										
Silent Burglary	Resident Monitor																										
Resident Response	General Monitor																										
General Response	Fire With Verification																										
Day/Night	Garage Monitor																										
<p>Alarm Report</p> <p>Yes</p>	<p>Alarm Report</p> <p>Note: This field is for Alarms. If Response Type "Trouble" is set up and Alarm Report is set to "No" the system will still report if Report Alarms was enabled in the Reporter programming.</p> <p>Select "Report" to toggle between "No" or "Yes". Select "Save".</p>																										
<p>Chime</p> <p>Disabled</p>	<p>Chime</p> <p>Note: Chime only applies to entry/exit, perimeter and interior zone types.</p> <p>Select "Chime" to scroll through the selections that include "Disabled" and ten optional chimes. Select "Save".</p>																										

Programming the Control

Program Zones (Continued)

<p>Supervision Supervised</p>	<p>Supervision The system displays the applicable Supervision options based upon the Device Type that was selected. Select "Supervision" to scroll between the following options:</p> <p>Hardwire Zone Normal Open Normal Closed End of Line</p> <p>RF Zone Supervised Unsupervised</p> <p>Temperature (Defaulted for Zones 180-187) Note: Zone 186 and 187 are only available on the L7000) High Temp (Default selection for Zones 180, 182, 184 and 186) Low Temp (Default selection for Zones 181, 183, 185 and 187) After making a Supervision selection, select "Save".</p>
<p>Arm Night No</p>	<p>Arm Night If "Motion Sensor" is selected in the Response Type Field, the Arm Night option will be available. Use the down ▼ arrow to scroll to the next page of options. Select "Arm Night" to toggle between "No" or "Yes". Select "Save".</p>

Programming the Control

Program Keys

The following system options are programmed in this section

Option	Function
Key Type	Select the specific type of key being entered or enrolled
User	Associates the Key with a specific User
Serial Number	Manually enter key serial number or enroll via RF transmission
Zone	Manually enter key zone number (between 140 and 155) or enroll via RF transmission
Button Key * - Zn *	Associate the selected button with a specific function

* Key number and Zn number are dependent upon the Key Type selected.

Note: If applicable, preprogrammed defaults for the L5210/L7000 Control are shown on the screen unless otherwise noted.

SCREEN	ACTION															
<div style="border: 1px solid black; padding: 5px; width: fit-content; margin: auto;"> Keys </div>	<p>1. Select "Keys" The System displays the following options:</p> <table style="margin-left: 40px;"> <tr> <td>Edit</td> <td>Add New</td> <td>Delete</td> </tr> </table> <p>2. Select "Add New".</p> <p>3. The following options are displayed (dependent upon the "Key Type" selected):</p> <table style="margin-left: 40px;"> <tr> <td>Key Type</td> <td>User</td> </tr> <tr> <td>Serial Number</td> <td>Zone</td> </tr> <tr> <td>Button Key 1 – Zn 140</td> <td>Button Key 2 – Zn 141</td> </tr> <tr> <td>Button Key 3 – Zn 142</td> <td>Button Key 4 – Zn 143</td> </tr> <tr> <td>Button Key 5 – Zn 144</td> <td>Button Key 6 – Zn 145</td> </tr> <tr> <td>Button Key 7 – Zn 146</td> <td>Button Key 8 – Zn 147</td> </tr> </table> <p>Select an option to display the next programming field.</p>	Edit	Add New	Delete	Key Type	User	Serial Number	Zone	Button Key 1 – Zn 140	Button Key 2 – Zn 141	Button Key 3 – Zn 142	Button Key 4 – Zn 143	Button Key 5 – Zn 144	Button Key 6 – Zn 145	Button Key 7 – Zn 146	Button Key 8 – Zn 147
Edit	Add New	Delete														
Key Type	User															
Serial Number	Zone															
Button Key 1 – Zn 140	Button Key 2 – Zn 141															
Button Key 3 – Zn 142	Button Key 4 – Zn 143															
Button Key 5 – Zn 144	Button Key 6 – Zn 145															
Button Key 7 – Zn 146	Button Key 8 – Zn 147															
<div style="border: 1px solid black; padding: 5px; width: fit-content; margin: auto;"> Key Type 4 Button key </div>	<p>Key Type Select "Key Type". The system scrolls between the following:</p> <table style="margin-left: 40px;"> <tr> <td>1 Button key</td> <td>6 Button key</td> </tr> <tr> <td>2 Button key</td> <td>8 Button key</td> </tr> <tr> <td>4 Button key</td> <td></td> </tr> </table>	1 Button key	6 Button key	2 Button key	8 Button key	4 Button key										
1 Button key	6 Button key															
2 Button key	8 Button key															
4 Button key																
<div style="border: 1px solid black; padding: 5px; width: fit-content; margin: auto;"> User </div>	<p>User Select "User" then select from the following options (or the list of Users that have been programmed):</p> <table style="margin-left: 40px;"> <tr> <td>Master</td> <td>Guest</td> </tr> <tr> <td>Duress</td> <td>User 3</td> </tr> <tr> <td>User 4</td> <td>User 5</td> </tr> <tr> <td>User 6</td> <td>User 7</td> </tr> </table> <p>Use the down ▼ arrow to scroll to the next page. The system displays options for User 8 through 30 (L5210) or 8 though 46 (L7000).</p> <p>Note: The Key must be associated with a specific User/User Code in order for it to operate. Refer to the LYNX Touch User Guide for additional Information regarding User Codes.</p>	Master	Guest	Duress	User 3	User 4	User 5	User 6	User 7							
Master	Guest															
Duress	User 3															
User 4	User 5															
User 6	User 7															
<div style="border: 1px solid black; padding: 5px; width: fit-content; margin: auto;"> Serial Number 0 </div>	<p>Serial Number When "Serial Number" has been selected "Enter Serial Number or Activate" is displayed. The transmitter serial number and loop number can be enrolled via RF transmission OR manually.</p> <p>Enroll via RF Learning To enroll the device using RF Learning mode three transmissions (open/close) of the device will be required. The initial transmission activates the RF Learning mode. A second transmission enrolls the serial number and the system beeps two times and displays "Activate Sensor Again To Confirm". A third transmission will confirm the serial number. The system beeps three times and returns to the Zone programming Screen.</p> <p>Enroll Manually Enter the 7-digit serial number printed on the transmitter using the displayed keypad and select "Done". The system beeps one time and returns to the Zone programming Screen.</p>															
<div style="border: 1px solid black; padding: 5px; width: fit-content; margin: auto;"> Zone 140 </div>	<p>Zone The system displays the next available key Zone number. Select "Zone" to manually enter a specific Zone Number on the displayed keypad (140-155 L5210 OR 140-163 L7000). If the desired Zone Number is not available, the system returns to the previous screen.</p> <p>Select "Done". The system returns to the previous screen. Repeat the previous step to enter another Zone Number.</p>															

Programming the Control

Program Keys (Continued)

SCREEN	ACTION										
<p>Button Key * - Zn *</p>	<p>Button Key * Zn * Select the desired Button Key and enter a function for each button key. The system displays the following options:</p> <table border="0"> <tr> <td>Disarm</td> <td>Arm Away</td> </tr> <tr> <td>Arm Stay</td> <td>No Response</td> </tr> <tr> <td>24 Hour Silent</td> <td>24 Hour Audible</td> </tr> <tr> <td>24 Hour Auxiliary</td> <td>Silent Burglary</td> </tr> <tr> <td>Fire No Verification</td> <td></td> </tr> </table> <p>* Options are the same for each Button/Zone combination.</p>	Disarm	Arm Away	Arm Stay	No Response	24 Hour Silent	24 Hour Audible	24 Hour Auxiliary	Silent Burglary	Fire No Verification	
Disarm	Arm Away										
Arm Stay	No Response										
24 Hour Silent	24 Hour Audible										
24 Hour Auxiliary	Silent Burglary										
Fire No Verification											

Programming the Control Program Reporting



When Compass service is required and GSM or IP are the only reporting channels: As part of Primary Central Station programming; the “Phone Type” must be set to any selection other than “None”, the “Communicator Type” must be set to GSM or IP, as applicable, and must match the compass value; “Phone number” field must be left blank and an “Account number” must be programmed.

The following system options are programmed in this section:

Option	Function
Primary or Secondary CS Info	Enroll information pertaining to the Primary and/or Secondary Central Station.
Phone Type	Select the Report Format that will be used to send reports to the Primary or Secondary Central Station, as applicable.
Phone Number	Enter the Phone Number for the Primary or Secondary Central Station, as applicable.
Communicator Type	Select the type of Communications Module that will be used to communicate with the Primary or Secondary Central Station, as applicable.
Account Number	Enter the account number for the Primary or Secondary Central Station, as applicable.
Dynamic Priority	Select the primary method for sending Reports to the Primary or Secondary Central Station, as applicable.
Dynamic Delay	Selects delay between switching between reporting methods. Active if Dynamic Delay feature has been set to Preferred Telco or Preferred Radio.
Report All	Enable All Reports to be sent to the Primary or Secondary Central Station, as applicable.
Report Alarms	Enable Alarm Reporting to the Primary or Secondary Central Station, as applicable.
Report Troubles	Enable Trouble Reporting to the Primary or Secondary Central Station, as applicable.
Report Open/Close	Enable Open/Close Reporting to the Primary or Secondary Central Station, as applicable.
Report Tests	Enable Test Reporting to the Primary or Secondary Central Station, as applicable.
Follow Me Phone 1 or Phone 2	Enroll information Primary and/or Secondary telephone numbers for “Follow Me” Announcements and/or Reminders. (This feature is only available on the LYNX Touch L5210/L5210CN)
Phone Type	Enter Number for Follow Me Phone 1 or Phone 2, as applicable.
Phone Number	Enter Primary and/or Secondary telephone numbers for “Follow Me” Announcements and/or Reminders.
Report All	Enable All Reports to be sent to the Follow Me Phone 1 or Phone 2, as applicable.
Report Alarms	Enable Alarm Reporting to the Follow Me Phone 1 or Phone 2, as applicable.
Report Troubles	Enable Trouble Reporting to the Follow Me Phone 1 or Phone 2, as applicable.
Report Open/Close	Enable Open/Close Reporting to the Follow Me Phone 1 or Phone 2, as applicable.
Report Tests	Enable Test Reporting to the Follow Me Phone 1 or Phone 2, as applicable.
Report Selection	Enable Reporting of Specific Events
Options	
PBX	Enter the digits required to access telephone service. (Not applicable to the L7000/L7000CN)
Call Wait Cancel	Enter the digits required to cancel call waiting, if applicable (Not applicable to the L7000/L7000CN)
Number of Reports	Limit the number of messages sent to the Central Station during an armed period.
Alarm Report Delay	Disable or select the time delay for alarm reporting (applies to L5210CN/L7000CN only)
Swinger Shutdown	Select the number of times reports are sent and sounder sounds for non-fire alarms before the system ignores subsequent alarms (applies to L5210/L7000 and only)
Abort Window	Select the time delay for alarm reporting (applies to L5210/L7000 only)
First Offset Report	Select the time for the first test report following power-up/programming or downloading
Report Frequency	Select the test report frequency
Downloader	
Phone Answer	Enable to allow control to answer incoming phone line. (Not applicable to the L7000/L7000CN)
Modem Speed	(Future Use)
Ans. Machine Defeat	Enable to defeat answering machine mode. (Active if Phone Answer feature is enabled.) (Not applicable to the L7000/L7000CN)
Ring Counter	Enter the number of rings before control picks up phone line. (Active if Ans. Machine Defeat is not enabled.)
Callback Number	Enter the phone number the control will use to call back the downloading computer. (Active if Phone Answer is enabled.)
Flexible Callback	Allows Download operator to temporarily change the callback number by the number of digits selected. Active if Phone Answer is enabled
Number	Enter the number of flexible callback numbers that will be used. Available if Flexible Callback is enabled.

Programming the Control

Program Reporting (Continued)

Notes: If applicable, preprogrammed defaults for the L5210/L7000 Control are shown on the screen unless otherwise noted. When GSM is used as the Primary Communications channel for any Total Connect service, the GSM Radio must be selected as the Primary Reporting Path (Preferred Radio).

SCREEN	ACTION								
<p>Reporter</p>	<p>Select "Reporter" The System displays the following options: <table border="0" style="width: 100%;"> <tr> <td style="width: 50%;">Primary CS Info</td> <td style="width: 50%;">Secondary CS Info</td> </tr> <tr> <td>Follow Me Phone 1*</td> <td>Follow Me Phone 2*</td> </tr> <tr> <td>Report Selection</td> <td>Options</td> </tr> <tr> <td>Downloader</td> <td></td> </tr> </table> Note: The Follow Me feature is not available on the LYNX Touch L7000 Series controls.</p>	Primary CS Info	Secondary CS Info	Follow Me Phone 1*	Follow Me Phone 2*	Report Selection	Options	Downloader	
Primary CS Info	Secondary CS Info								
Follow Me Phone 1*	Follow Me Phone 2*								
Report Selection	Options								
Downloader									
<p>Primary CS Info</p>	<p>Select "Primary CS Info". The System displays the following options: <table border="0" style="width: 100%;"> <tr> <td style="width: 50%;">Phone Type</td> <td style="width: 50%;">Communicator Type</td> </tr> </table></p>	Phone Type	Communicator Type						
Phone Type	Communicator Type								
<p>Phone Type Contact Id: 4 Digit</p>	<p>Select "Phone Type". The System scrolls though the following options: None Contact Id: 4 Digit Contact Id: 10 Digit SIA</p>								
<p>Communicator Type None</p>	<p>Select "Communicator Type". The System scrolls though the following options: None GSM WiFi WiFi & GSM IP Note: The system will display the communications (GSM, WiFi or IP) paths based on the selection made in Communicator Programming. The Communication Path selection can be enabled for either Primary Central Station or Secondary Central Station but not both. If it is enabled in one it will not be available for the other Central Station. If APL is used, GSM, WiFi or IP must be selected as the Primary Communicator Type.</p>								
<p>Phone Number</p>	<p>If any option other than "None" is selected in "Phone Type" The "Phone Number" option will be displayed. Select "Phone Number". Enter the Primary Central Station Phone Number on the displayed keypad. (Up to 20 digits)</p>								
<p>Account Number FFFF</p>	<p>If any option other than "None" is selected in "Phone Type" The "Account Number" option will be displayed. Select "Account Number". Enter the Primary Central Station Account Number on the displayed keypad.</p>								
<p>Dynamic Priority Redundant Reports</p>	<p>If any option other than "None" is selected in "Communicator Type" The "Dynamic Priority" option will be displayed. "Select "Dynamic Priority". The system scrolls between "Redundant Reports", "Preferred Telco" and Preferred Radio".</p>								
<p>Dynamic Delay 30 Seconds</p>	<p>If any option other than "Redundant Reports" is selected in "Dynamic Priority" The "Dynamic Delay" option will be displayed. "Select "Dynamic Delay". The system scrolls between "15 Seconds", "30 Seconds", "60 Seconds" and "90 Seconds". Note: If GSM is selected as the primary reporting channel Dynamic Delay should be set to minimum of 60 seconds.</p>								
<p>Report All Press to Report All</p>	<p>Select "Report All". The System toggles between "Press to Report All" and "Report All Set". If "Report All" is selected all reporting options will be "Enabled". Select the "Save" key to return to the Reporter options screen.</p>								
<p>Report Alarms Enabled</p>	<p>Select "Report Alarms". The System toggles between "Disabled" and "Enabled". SIA: The L5210/L7000 Touch default is "Enabled".</p>								
<p>Report Troubles Enabled</p>	<p>Select "Report Troubles". The System toggles between "Disabled" and "Enabled". SIA: The L5210/L7000 default is "Enabled".</p>								
<p>Report Open/Close Disabled</p>	<p>Select "Open/Close". The System toggles between "Disabled" and "Enabled".</p>								
<p>Report Tests Enabled</p>	<p>Select "Report Tests". The System toggles between "Disabled" and "Enabled". SIA: The L5210/L7000 default is "Enabled" and is not selectable.</p>								

**Programming the Control
Program Reporting (Continued)**

SCREEN	ACTION
Secondary CS Info	Select "Secondary CS Info". The System displays the following options: Phone Type Communicator Type
Phone Type None	Select "Phone Type". The System displays the following options: None Contact Id: 4 Digit Contact Id: 10 Digit SIA
Communicator Type None	Select "Communicator Type". The System displays the following options: None GSM WiFi WiFi & GSM IP Note: The system will display the communications path (GSM, WiFi or IP) selected in Communications Programming. The path can be enabled for either primary Central Station or Secondary Central Station but not both. If it is enabled in one it will not be available for the other Central Station.
Phone Number	If any option other than "None" is selected in "Phone Type", the "Phone Number" option will be displayed. Select "Phone Number". Enter the Secondary Central Station Phone Number on the displayed keypad. (Up to 20 digits)
Account Number FFFF	If any option other than "None" is selected in "Phone Type" The "Account Number" option will be displayed. Select "Account Number". Enter the Secondary Central Station Account Number on the displayed keypad.
Dynamic Priority Redundant Reports	If any option other than "None" is selected in "Communicator Type" The "Dynamic Priority" option will be displayed. "Select "Dynamic Priority". The system scrolls between "Redundant Reports", "Preferred Telco" and Preferred Radio".
Dynamic Delay 30 Seconds	If any option other than "Redundant Reports" is selected in "Dynamic Priority" The "Dynamic Delay" option will be displayed. "Select "Dynamic Delay". The system scrolls between "15 Seconds", "30 Seconds", "60 Seconds" and "90 Seconds". Note: If GSM is selected as the primary reporting channel Dynamic Delay should be set to minimum of 60 seconds.
Report All Press to Report All	Select "Report All". The System toggles between "Press to Report All" and "Report All Set". If "Report All" is selected all reporting options will be "Enabled". Select the "Save" key to return to the Reporter options screen.
Report Alarms Enabled	Select "Report Alarms". The System toggles between "Disabled" and "Enabled".
Report Troubles Enabled	Select "Report Troubles". The System toggles between "Disabled" and "Enabled".
Report Open/Close Disabled	Select "Open/Close". The System toggles between "Disabled" and "Enabled".
Report Tests Enabled	Select "Report Tests". The System toggles between "Disabled" and "Enabled". SIA: The L5210/L7000 default is "Enabled" and is not selectable.
Follow Me Phone 1	Note: The Follow Me feature is not available on the LYNX Touch L7000/L7000CN. Select "Follow Me Phone 1" to program the "Follow Me" Reminder telephone number 1
Phone Type None	Note: This field is not available on the LYNX Touch L7000/L7000CN. Select "Phone Type". The System toggles between "None" and "Follow Me".
Phone Number	Note: This field is not available on the LYNX Touch L7000/L7000CN. Select "Phone Number". Enter the "Follow Me" Phone Number 1 on the displayed keypad.

Programming the Control

Program Reporting (Continued)

SCREEN	ACTION										
<p>Report All Press to Report All</p>	<p>Note: This field is not available on the LYNX Touch L7000/L7000CN. Select "Report All". The System toggles between "Press to Report All" and "Report All Set". If "Report All" is selected all reporting options will be "Enabled". Select the "Save" key to return to the Reporter options screen.</p>										
<p>Report Alarms Disabled</p>	<p>Note: This field is not available on the LYNX Touch L7000/L7000CN. Select "Report Alarms". The System toggles between "Disabled" and "Enabled".</p>										
<p>Report Troubles Disabled</p>	<p>Note: This field is not available on the LYNX Touch L7000/L7000CN. Select "Report Troubles". The System toggles between "Disabled" and "Enabled".</p>										
<p>Report Open/Close Disabled</p>	<p>Note: This field is not available on the LYNX Touch L7000/L7000CN. Select "Open/Close". The System toggles between "Disabled" and "Enabled".</p>										
<p>Report Tests Disabled</p>	<p>Note: This field is not available on the LYNX Touch L7000/L7000CN. Select "Report Tests". The System toggles between "Disabled" and "Enabled".</p>										
<p>Follow Me Phone 2</p>	<p>Note: The Follow Me feature is not available on the LYNX Touch L7000/L7000CN. Select "Follow Me Phone 2" to program the "Follow Me" Reminder telephone number 2.</p>										
<p>Phone Type None</p>	<p>Note: This field is not available on the LYNX Touch L7000/L7000CN. Select "Phone Type". The System toggles between "None" and "Follow Me".</p>										
<p>Phone Number</p>	<p>Note: This field is not available on the LYNX Touch L7000/L7000CN. Select "Phone Number". Enter the "Follow Me" Phone Number 2 on the displayed keypad.</p>										
<p>Report All Press to Report All</p>	<p>Note: This field is not available on the LYNX Touch L7000/L7000CN. Select "Report All". The System toggles between "Press to Report All" and "Report All Set". If "Report All" is selected all reporting options will be "Enabled". Select the "Save" key to return to the Reporter options screen.</p>										
<p>Report Alarms Enabled</p>	<p>Note: This field is not available on the LYNX Touch L7000/L7000CN. Select "Report Alarms". The System toggles between "Disabled" and "Enabled".</p>										
<p>Report Troubles Enabled</p>	<p>Note: This field is not available on the LYNX Touch L7000/L7000CN. Select "Report Troubles". The System toggles between "Disabled" and "Enabled".</p>										
<p>Report Open/Close Disabled</p>	<p>Note: This field is not available on the LYNX Touch L7000/L7000CN. Select "Open/Close". The System toggles between "Disabled" and "Enabled".</p>										
<p>Report Tests Enabled</p>	<p>Note: This field is not available on the LYNX Touch L7000/L7000CN. Select "Report Tests". The System toggles between "Disabled" and "Enabled".</p>										
<p>Report Selection</p>	<p>Select "Report Selection". The System displays the following options:</p> <table border="0" style="width: 100%;"> <tr> <td style="width: 50%; text-align: center;"> Arm Away Disarm Recent Closing Trouble </td> <td style="width: 50%; text-align: center;"> Arm Stay Exit Error Event Log Full Trouble Restore </td> </tr> <tr> <td colspan="2" style="text-align: center;"> Use the down ▼ arrow to scroll to the next page of options. </td> </tr> <tr> <td style="width: 50%; text-align: center;"> Alarm Restore Test Bypass AC Loss </td> <td style="width: 50%; text-align: center;"> Alarm Cancel Test Restore Bypass Restore AC Loss Restore </td> </tr> <tr> <td colspan="2" style="text-align: center;"> Use the down ▼ arrow to scroll to the next page of options. </td> </tr> <tr> <td style="width: 50%; text-align: center;"> Low Battery RF Low Battery </td> <td style="width: 50%; text-align: center;"> Low Battery Restore RF Low Battery Restore </td> </tr> </table>	Arm Away Disarm Recent Closing Trouble	Arm Stay Exit Error Event Log Full Trouble Restore	Use the down ▼ arrow to scroll to the next page of options.		Alarm Restore Test Bypass AC Loss	Alarm Cancel Test Restore Bypass Restore AC Loss Restore	Use the down ▼ arrow to scroll to the next page of options.		Low Battery RF Low Battery	Low Battery Restore RF Low Battery Restore
Arm Away Disarm Recent Closing Trouble	Arm Stay Exit Error Event Log Full Trouble Restore										
Use the down ▼ arrow to scroll to the next page of options.											
Alarm Restore Test Bypass AC Loss	Alarm Cancel Test Restore Bypass Restore AC Loss Restore										
Use the down ▼ arrow to scroll to the next page of options.											
Low Battery RF Low Battery	Low Battery Restore RF Low Battery Restore										
<p>Arm Away Enabled</p>	<p>Select "Arm Away". The System toggles between "Disabled" and "Enabled".</p>										

Programming the Control
Program Reporting (Continued)

SCREEN	ACTION
Arm Stay Enabled	Select "Arm Stay". The System toggles between "Disabled" and "Enabled".
Disarm Enabled	Select "Disarm". The System toggles between "Disabled" and "Enabled".
Exit Error Enabled	Select "Exit Error". The System toggles between "Disabled" and "Enabled". SIA: The L5210/L7000 default is "Enabled" and is not selectable.
Recent Closing Enabled	Select "Recent Closing". The System toggles between "Disabled" and "Enabled". SIA: The L5210/L7000 default is "Enabled" and is not selectable.
Event Log Full Enabled	Select "Event Log Full". The System toggles between "Disabled" and "Enabled".
Trouble Enabled	Select "Trouble". The System toggles between "Disabled" and "Enabled".
Trouble Restore Enabled	Select "Trouble Restore". The System toggles between "Disabled" and "Enabled".
Alarm Restore Enabled	Select "Alarm Restore". The System toggles between "Disabled" and "Enabled".
Alarm Cancel Enabled	Select "Alarm Cancel". The System toggles between "Disabled" and "Enabled".
Test Enabled	Select "Test". The System toggles between "Disabled" and "Enabled". SIA: The L5210/L7000 default is "Enabled" and is not selectable.
Test Restore Enabled	Select "Test Restore". The System toggles between "Disabled" and "Enabled". SIA: The L5210/L7000 default is "Enabled" and is not selectable.
Bypass Enabled	Select "Bypass". The System toggles between "Disabled" and "Enabled".
Bypass Restore Enabled	Select "Bypass Restore". The System toggles between "Disabled" and "Enabled".
AC Loss Enabled	Select "AC Loss". The System toggles between "Disabled" and "Enabled".
AC Loss Restore Enabled	Select "AC Loss Restore". The System toggles between "Disabled" and "Enabled".
Low Battery Enabled	Select "Low Battery". The System toggles between "Disabled" and "Enabled".
Low Battery Restore Enabled	Select "Low Battery Restore". The System toggles between "Disabled" and "Enabled".
RF Low Battery Enabled	Select "RF Low Battery". The System toggles between "Disabled" and "Enabled".
RF Low Battery Restore Enabled	Select "RF Low Battery Restore". The System toggles between "Disabled" and "Enabled".

Programming the Control

Program Reporting (Continued)

SCREEN	ACTION						
Options	Select "Options". The System displays the following options: <table border="0" style="width: 100%;"> <tr> <td style="width: 50%; text-align: center;">PBX</td> <td style="width: 50%; text-align: center;">Call Wait Cancel</td> </tr> <tr> <td style="text-align: center;">Number of Reports</td> <td style="text-align: center;">Alarm Report Delay</td> </tr> <tr> <td style="text-align: center;">First Report Offset</td> <td style="text-align: center;">Report Frequency</td> </tr> </table>	PBX	Call Wait Cancel	Number of Reports	Alarm Report Delay	First Report Offset	Report Frequency
PBX	Call Wait Cancel						
Number of Reports	Alarm Report Delay						
First Report Offset	Report Frequency						
PBX	Note: This field is not available on the LYNX Touch L7000/L7000CN. Select "PBX", and enter PBX Prefix on the displayed keypad.						
Call Wait Cancel	Note: This field is not available on the LYNX Touch L7000/L7000CN. Select "Call Wait Cancel", and enter Call Wait Cancel Prefix on the displayed keypad						
Number of Reports 2 Reports	Select "Number of Reports" LYNX Touch (L5210/L7000) The system scrolls between the following options: 1, 2, 3, 4, 5 and 6 Reports LYNX Touch (L5210CN/L7000CN) Canada The system toggles between "Unlimited" and "10 Reports".						
Alarm Report Delay 30 Sec.	Select "Alarm Report Delays". The System scrolls between the following options: 15 Sec. 30 Sec. 45 Sec. No delay SIA The Alarm Report Delay (burglary abort window) must be set to a minimum of 15 seconds. The sum of the Alarm Report Delay (burglary abort window) and the entry delays should not exceed 1 minute. Note: The L5210/L7000 control validates the data entered in this field. If the selection is not valid the control will emit a single long beep indicating that the selection has been rejected. The control replaces the selection with the default value "30 Sec".						
First Report Offset 6 Hrs	Select "First Report Offset" for the Test Report. The System scrolls between the following options: 6 Hrs 12 Hrs 18 Hrs 24 Hrs						
Report Frequency Never	Select "Report Frequency" for the Test Report. The System scrolls between the following options: Never Every Day Every 7 Days Every 30 Days						
Downloader	Select "Downloader". The System displays the following options: <table border="0" style="width: 100%;"> <tr> <td style="width: 50%; text-align: center;">Phone Answer</td> <td style="width: 50%; text-align: center;">Modem Speed</td> </tr> <tr> <td style="text-align: center;">Ans.Machine Defeat</td> <td style="text-align: center;">Callback Number</td> </tr> <tr> <td style="text-align: center;">Ring Counter</td> <td style="text-align: center;">Flexible Callback Number</td> </tr> </table>	Phone Answer	Modem Speed	Ans.Machine Defeat	Callback Number	Ring Counter	Flexible Callback Number
Phone Answer	Modem Speed						
Ans.Machine Defeat	Callback Number						
Ring Counter	Flexible Callback Number						
Phone Answer Yes	Note: This field is not available on the LYNX Touch L7000/L7000CN. Select "Phone Answer", the system toggles between "Yes" and "No".						
Modem Speed Slow	(Future Use)						
Ans. Machine Defeat Yes	Note: This field is not available on the LYNX Touch L7000/L7000CN. Select "Ans. Machine Defeat", the system toggles between "Yes" and "No".						
Callback Number	Select "Callback Number" and enter callback number on the displayed keypad.						

Programming the Control
Program Reporting (Continued)

Ring Counter 2	This option only appears if Answering Machine defeat is set to "No". Enter ring counter (1 – 14 rings) on the displayed keypad.
Flexible Callback No	Select "Flexible Callback", the system toggles between "Yes" and "No".
Number 1	This option only appears if "Flexible Callback" is set to "Yes". The system scrolls between options 1, 2 and 3.

Programming the Control

Program Sounder

The following system options are programmed in this section:

Option	Function
Burglary Alarm Sound	Reduces the full 85 dB burglary alarm sound for testing.
Burglary Bell Timeout	Select the time for timeout of the Burglary Alarm sounder.
Fire Bell Timeout	Select the time for timeout of the Fire Alarm sounder.
Arm Confirm	Enable sounder "ding" when system is armed via the selected RF device.
Alarm Options	Select a limit for the number of times an alarm can sound for a specific zone. Note: This option does not apply to the L5210/L7000 controls.

Note: If applicable, preprogrammed defaults for the L5210/L7000 Control are shown on the screen unless otherwise noted.

SCREEN	ACTION						
<p>Sounder</p>	<p>Select "Sounder" The System displays the following options:</p> <table border="0"> <tr> <td>Burglary Alarm Sound</td> <td>Burglary Bell Timeout</td> </tr> <tr> <td>Fire Bell Timeout</td> <td>Arm Confirm</td> </tr> <tr> <td>Alarm Options</td> <td></td> </tr> </table>	Burglary Alarm Sound	Burglary Bell Timeout	Fire Bell Timeout	Arm Confirm	Alarm Options	
Burglary Alarm Sound	Burglary Bell Timeout						
Fire Bell Timeout	Arm Confirm						
Alarm Options							
<p>Burglary Alarm Sound Yes</p>	<p>Select "Burglary Alarm Sound". The System toggles between the following options: Yes (Full volume) No (Test volume – installer mode)</p>						
<p>Burglary Bell Timeout 4 Minutes</p>	<p>Select "Burglary Bell Timeout". The System scrolls between the following options: No 4 Minutes 8 Minutes 12 Minutes 16 Minutes</p>						
<p>Fire Bell Timeout 4 Minutes</p>	<p>Select "Fire Bell Timeout". The System scrolls between the following options: No 4 Minutes 8 Minutes 12 Minutes 16 Minutes</p>						
<p>Arm Confirm RF Keyfob</p>	<p>Select "Arm Confirm". The System scrolls between the following options: None All RF RF Key Fob RF Keypad</p>						
<p>Alarm Options Unlimited</p>	<p>Note: This option does not apply to the L5210/L7000 Control. Select "Alarm Options". The System scrolls between the following options: Unlimited 1 2 10 Select "Save".</p>						

Programming the Control

Program System Settings

The following system options are programmed in this section:

Option	Function
Entry Delay1/Entry Delay 2	Selects an Entry Delay time in seconds. The system will wait the time entered before sounding alarm upon entering if system is not disarmed. Note: The Default values differ for the L5210/L7000 and L5210CN/L7000CN controls.
Exit Delay	Selects an Exit Delay time in seconds for both Entry Delay 1 and 2 Zone Types. The system will wait the time entered before sounding an alarm if the exit door is left open after the system has been armed. Note: The Default values differ for the L5210/L7000 and L5210CN/L7000CN controls.
Backlight Timeout	Enable or disable display backlight turnoff after 30 seconds.
Quick Arm	Enables or disables Quick Arm Mode. If enabled, security code is not required to arm the system. The user simply presses the AWAY button (ICON) and then selects the "Quick Arm" button on the displayed keypad to arm the system.
Quick Exit	Enables or disables Quick Exit Mode. If enabled allows the user restart the exit delay to allow entry or exit when the system is armed
Restart Exit Time	Enables or disables Restart Exit Time Mode. This option allows the control to restart the exit delay time (one time) after arming in STAY or AWAY mode by selecting the Restart key (if quick arming is enabled) or by selecting the Restart key and entering the User Code (if quick arming is disabled). This option also enables automatic exit delay reset, which resets exit delay if the entry/exit door is re-opened and closed before exit delay time expires after arming.
Force Bypass	Enables or disables Force Bypass Mode. All zones bypassed by this function will be displayed after the bypass is initiated. The Fire and CO Zones are not bypassed in the L5210/L7000.
Exit Warning	Enables or disables Exit Warning sound. Audible Exit Warning sound consists of slow continuous beeps until last 10 seconds, when it changes to fast beeps. The warning sound will end at the termination of exit delay. Note: This field is not programmable in the L5210/L7000 and is always enabled.
Auto Stay Arming	Enables or disables Auto Stay Arming Mode. If this feature is enabled and the Control Panel has been armed "Armed Away" at the LYNX Touch keypad or RF keypad, the system will switch to the "Armed Stay" mode if the Exit Time has expired and no exit has been made.
Lack of Usage Notify	Enables or disables Lack of Usage Notification feature. If enabled, notifies the Central Station if an end user is not operating their security system by sending a System Inactivity report 654. The report will be sent only to the Primary phone number and only if Contact ID@ format was selected.
Power-Up in Previous	Enables or disables Power-Up in Previous Mode feature. When the system powers up armed, an alarm will occur 1 minute after arming if a zone is faulted. For the L5210CN/L7000CN control any bypassed zones will be unbypassed. For the L5210/L7000 any bypassed zones will remain bypassed.
Display Alarm Cancel	Enables or disables display of Cancelled Alarm.
Display Exit Time	Enables or disables display of Exit Time.
Cross Zone Delay	Sets the maximum amount of time in which two zones must be tripped in an armed system to send an alarm message to the Central Station. If only one cross zone is tripped during this time, a trouble message (CID code 380) for that zone is sent to the Central Station.
Cross Zone 1/Cross Zone 2	Select the zones that will be used for Cross Zoning

Programming the Control
Program System Settings (Continued)

SCREEN	ACTION
Backlight Timeout No	Select "Backlight Timeout". The System toggles between No and 30 Seconds.
Quick Arm Yes	Select "Quick Arm". The System toggles between Yes and No.
Quick Exit Yes	Select "Quick Exit". The System toggles between Yes and No.
Restart Exit Time Yes	Select "Restart Exit Time". The System toggles between Yes and No. SIA: The L5210/L7000 default is "Yes".
Force Bypass No	Select "Force Bypass". The System toggles between Yes and No. UL installations: must be NO (no forced bypass)
Exit Warning Yes	Select "Exit Warning". The System toggles between Yes and No. SIA: The L5210/L7000 default is "Yes" and is not selectable.
Auto Stay Arming Yes	Select "Auto Stay Arming". The System toggles between Yes and No. SIA: The L5210/L7000 default is "Yes".
Lack of Usage Notify Disabled	Select "Lack of Usage Notify". The System scrolls between the following options: Disabled 1 Day 90 Days 7 Days 180 Days 27 Days 365 Days
Power-Up In Previous Yes	Select "Power-Up In Previous". The System toggles between Yes and No. Note: If the previous state was Armed Away or Stay, the system will not respond to sensor changes for 1 minute. This allows time for sensors such as PIRs to stabilize. UL installations: must be Yes (power up in previous state) SIA: The L5210/L7000 default is "Yes" and is not selectable.
Display Alarm Cancel Yes	Select "Display Alarm Cancel". The System toggles between Yes and No.
Display Exit Time Yes	Select "Display Exit Time". The System toggles between Yes and No.
Cross Zone Delay None	Select "Cross Zone Delay". The System toggles between the following: None 30 Seconds 1 Minute 90 Seconds 2 Minutes 3 Minutes 4 Minutes Note: Cross zoning cannot be used in conjunction with APL.
Cross Zone 1 Disabled	Select "Cross Zone 1". The System toggles between the following: Disabled Note: If Cross Zone Delay is enabled the system will display the zones that are programmed with the following Zone Types: Day/Night, Interior Follower and perimeter.
Cross Zone 2 Disabled	Select "Cross Zone 2". The System toggles between the following: Disabled Note: If Cross Zone Delay is enabled the system will display the zones that are programmed with the following Zone Types: Day/Night, Interior Follower and perimeter.

Programming the Control Communications Diagnostics

Communications Status – The system provides a status of the IP or GSM communications paths and performs a self-test of the AES encryption algorithm as follows:

Message		Meaning
GSM: OR IP:	OK	Normal; No fault. (IP or GSM)
	Fault Reported!	No network connectivity and fault time has expired. (IP or GSM)
	Not Connected	No network connectivity over IP and fault time has NOT yet expired.
	Not Registered!	No network connectivity over GSM and fault time has NOT yet expired.
	No Physical Link	No network connectivity over IP and fault time is set to 0.
Encryption:	AES Passed!	Test successful.
	AES Failed!	Test failed.
	No Encryption!	No encryption algorithm set.
AlarmNet Registration:	Registered	Communication Device is Registered with AlarmNet.
	Not Registered	Communication Device is not Registered with AlarmNet.

Ethernet Information – Displays IP information, if the IP communication path is enabled.

Physical Link: Confirms the physical link connection to the internet and the connections speed.
 DHCP: DHCP (Dynamic Host Configuration Protocol) indicates server is performing satisfactorily.
 NIC IP Address: Displays the IP address assigned to this device
 Subnet Mask: Displays the 32-bit address mask used to indicate the portion (bits) of the IP address that is being used for the subnet address.
 Gateway IP Address: Displays the IP address assigned to the Gateway.
 DNS Server IP Address: Displays the IP address assigned to the DNS (Domain Name System) server.

Message		Meaning
Physical Link	10 Mbps or 100 Mbps	Link speed of physical connection
	Bad	No physical connection
DHCP	OK	DHCP address resolved
	Bad	DHCP address not resolved
	Off	DHCP disabled

GSM Information – Displays GSM information if GSM communication path is enabled.

Status	Message		Meaning
GSM Registered	Cell Registration:	Home 2G	Registered Home with 2G Service
		Home 3G	Registered Home with 3G/4G Service
		Roaming	Registered Roaming
	Primary RSSI:	(See RSSI Note below)	Primary Site RSSI level signal strength (1 to 5 stars or "Not Present" will be displayed)
		GPRS: (2G Only) (Always available in 3G/4G)	Yes No
	Country:	xxx	Country Code
	Network:	xxx	Network Code
	LAC	xxxxx	Local Area Code
	Cell: (2G only)	xxxx	Base Station ID
	Cell: (3G/4G only)	xxxxxx	Base Station ID
	Base Station: (2G Only)	xx	Base Station Antenna Sector
	Pri Sync Code (3G/4G Only)	xxx	Primary Sync Code
	Channel:	xxxx	Control Channel in use
Second Site RSSI:	(See RSSI Note below)	Secondary Site RSSI level availability ("Present" OR "Not Present" will be displayed)	
GSM Not Registered	Searching For Coverage!		Searching for cell network.
	SIM Error!		No SIM card present or SIM card faulty
	Cell Registration: SIM Not Active		SIM is not activated
	Cell Registration: Not Registered		Not registered with cell network

RSSI Note: Primary Site Signal strength is displayed by a series of 1 to 5 stars (* weak to ***** strong) or "Not Present" if there is no signal. To ensure a reliable installation at least 2 (**) stars should consistently be present. Secondary site presence is indicated by "Present" or "Not Present".

Programming the Control

Communications ID Numbers – Displays programmed SIM card information

Message		Meaning
MAC:	xxxxxxxxxxxx	MAC Address indicates the unique identification number for installed communications module(s)
MAC CRC:	xxxx	MAC CRC number for installed communications module(s)
WiFi:*	xxxxxxxxxxxx	Physical MAC Address of the WiFi module
WiFi Ver:	x.x.x	WiFi module software version
SCID:**	xxxxxxxxxxxxxxxxxxxx	Displays the ID number assigned to the installed SIM card (SCID)
IMEI:**	xxxxxxxxxxxxxxx	Displays the ID number assigned to the installed GSM module.

* This is the system MAC that should be referenced whenever speaking with technical support.

** Displayed if GSM communication path is enabled.

Test Communications – Performs network diagnostics and sends test alarms to AlarmNet. The following tests are available depending on the type of communications module installed.

Test Ethernet

This test is available if IP communication path is enabled. The network diagnostic process tests the integrity of the links between the LYNX Touch and the various connection points of AlarmNet Control that are known as “Redirectors”. If a physical link is detected and is ready, the following diagnostics are performed.

Testing Gateway... Traces the connection to the Gateway and displays the following:

Testing Gateway – Successful! A successful trace to Gateway. OR
 Testing Gateway – Failed! Failed to reach Gateway.

Testing Redirector * Sequentially traces the connection to Redirector 1, 2 and 3 at AlarmNet Control. The following will be displayed.

Redirector * – Service OK Service at AlarmNet Control on Redirector 1, 2 or 3 is functioning. OR
 Redirector * – Failed Error occurred on Redirector 1, 2 or 3.

* = Number of the director being tested is displayed

A summary of the tests is displayed after Redirector 3 is tested. The example shows that the tests of all three connection points, or Redirectors, were successful. If an error occurred at any point, the summary will display “Failed” next to the faulty Redirector.

Redirector 1 – Service OK
 Redirector 2 – Service OK
 Redirector 3 – Service OK

If no physical link is detected, the test is aborted and one of the following is displayed:

No Physical Link No physical link is detected.
 Link Not Ready There is a link but it is not ready (address not resolved).

Send Any

If both IP and GSM communication paths are enabled and the LYNX Touch is registered, a Test alarm is sent over IP path. If that is not successful, it sends the alarm over GSM path and the following message is displayed: **Test Message Sent**

If the device is not registered, the following is displayed: **Test Message Failed – Not Registered**

Send GSM Message

If GSM communication path is enabled and the LYNX Touch is registered, a Test alarm to AlarmNet over the GSM path. The following message is displayed: **Test Message Sent**

If the device is not registered, the following message is displayed: **Test Message Failed – Not Registered**

Send Ethernet Message

If IP communication path is enabled and the LYNX Touch is registered, a Test alarm to AlarmNet over the IP path. The following message is displayed: **Test Message Sent**

If the device is not registered, the following message is displayed: **Test Message Failed – Not Registered**

Setup Communication – Performs registration of the LYNX Touch and its associated communication module with AlarmNet updates configuration files or reset factory defaults.

Registering the LYNX Touch

Once the LYNX Touch is initialized and a communications module is programmed, it must be registered to enable the account. Upon completion of the registration process, the LYNX Touch transmits a registration message and receives a registration validation indicating that the account is now enabled. Wait for the “Registration Success” message to appear, regardless of which registration method is used.

You can register the communications module by one of the following methods:

- Through the AlarmNet Direct website
- By Phone
- Through the LYNX Touch Diagnostics

Programming the Control

Register through AlarmNet Direct Website

If the communications module has been programmed through AlarmNet Direct, the data must be transferred to the module, and the module must be registered by visiting:

<https://services.alarmnet.com/AlarmNetDirect/userlogin.aspx>.

Log in and follow the on-screen prompts.

If required, click on “Dealer Signup” from the login screen to gain access to the Honeywell web-based programming.

Dealer Sign-Up Direct Link: https://services.alarmnet.com/AlarmNetDirectP_Sign-Up.

Complete the sign-up form then follow the instructions. Only one sign-up per dealer is required. Once an initial user is established, additional logins may be created by that user.

Please have the following information available when programming the device:

1. Primary City ID (two-digit number)
2. Primary Central Station ID (two-digit hexadecimal number)
3. Primary Subscriber ID (four-digit number)
4. MAC ID and MAC CRC number (located on outside of box and on label inside module. Once the module is registered, log out of the AlarmNet Direct website.

Register by Phone

To register the module by telephone, call the AlarmNet Technical Assistance Center (TAC) at 1-800-222-6525.

Please have the following information available:

- MAC number (found on the label).
- Subscriber information (provided by the Central Station), including a city code, CSID, and a subscriber ID.
- When instructed to do so, select **Register Device** in the LYNX Touch Diagnostics to complete the registration.

Register through LYNX Touch Diagnostics

Register the module using the LYNX Touch Diagnostics and the following procedure.

SCREEN	ACTION						
Comm. Diagnostics	<p>1. Select “Comm. Diagnostics” The System displays the following options depending upon the communication device that is installed:</p> <table style="width: 100%; border-collapse: collapse;"> <tr> <td style="text-align: center; width: 33%; border-right: 1px solid black;">WiFi Location None</td> <td style="text-align: center; width: 33%; border-right: 1px solid black;">Configure WiFi</td> <td style="text-align: center; width: 33%;">Ethernet Information GSM Information</td> </tr> </table> <p>Use the down ▼ arrow to scroll to the next page of options. Use the ▲ arrow to return to the previous page:</p> <table style="width: 100%; border-collapse: collapse;"> <tr> <td style="text-align: center; width: 33%; border-right: 1px solid black;">Communication Status</td> <td style="text-align: center; width: 33%; border-right: 1px solid black;">Test Communication</td> <td style="text-align: center; width: 33%;">Setup Communication Communication ID Numbers</td> </tr> </table>	WiFi Location None	Configure WiFi	Ethernet Information GSM Information	Communication Status	Test Communication	Setup Communication Communication ID Numbers
WiFi Location None	Configure WiFi	Ethernet Information GSM Information					
Communication Status	Test Communication	Setup Communication Communication ID Numbers					
Setup Communication	<p>2. Select “Setup Communication”. The System advances to the Registration screen and the following options are displayed:</p> <table style="width: 100%; border-collapse: collapse;"> <tr> <td style="text-align: center; width: 50%; border-right: 1px solid black;">Register Device Update Server</td> <td style="text-align: center; width: 50%;">Register Device With PIN Factory Defaults</td> </tr> </table> <p>3. Select “Register Device”. The registration message is sent and the unit waits for the acknowledgement. (Refer to the table below for applicable registration messages.)</p> <p>Note: Register Device can be cancelled by selecting “Cancel”. The registration process is aborted and the message Registration Cancelled! is displayed.</p>	Register Device Update Server	Register Device With PIN Factory Defaults				
Register Device Update Server	Register Device With PIN Factory Defaults						

Programming the Control

During the registration process the following messages may be displayed:

Message	Meaning
Getting Configuration File...	The configuration file is obtained from AlarmNet if the module was programmed through AlarmNet Direct or a previously programmed module was defaulted.
Registering...	The registration message is sent and the unit is waiting for the acknowledgement.
Registration Successful!	The module is registered and is now in full service and available for alarm reporting to the Central Station.
Registering – Try Later!	Error Message indicates the module is busy.
Registration Failed!	Error message followed by one of the messages below:
Invalid Configuration!	Indicates the configuration is invalid.
Timed Out.	Displayed if no response to the registration request is received.
Central Station Database Full.	Indicates CS database has more than 1000 subscribers.
Primary Sub ID Bad.	Indicates the city, Central Station, or customer number for the labeled account is not accepted. The ID information was either entered incorrectly, or the Central Station failed to pre-authorize programmed ID numbers with AlarmNet customer service.
Primary ID – Need PIN.	Indicates the city, Central Station, or customer number for the labeled account is not accepted. The ID information was either entered incorrectly, or the Central Station failed to pre-authorize programmed ID numbers with AlarmNet customer service. See the <i>Register Device With PIN</i> section.
Account Disabled.	Displayed if the account is disabled in AlarmNet.

Register Device with PIN

This procedure is used to replace one LYNX Touch module with another.

SCREEN	ACTION						
Comm. Diagnostics	<p>1. Select “Comm. Diagnostics” The System displays the following options depending upon the communication device that is installed:</p> <table border="1"> <tr> <td>Communication Status</td> <td>Ethernet Information</td> <td>GSM Information</td> </tr> <tr> <td>Communication ID Numbers</td> <td>Test Communication</td> <td>Setup Communication</td> </tr> </table>	Communication Status	Ethernet Information	GSM Information	Communication ID Numbers	Test Communication	Setup Communication
Communication Status	Ethernet Information	GSM Information					
Communication ID Numbers	Test Communication	Setup Communication					
Setup Communication	<p>2. Select “Setup Communication”. The System advances to the Registration screen and the following options are displayed:</p> <table border="1"> <tr> <td>Register Device</td> <td>Register Device With PIN</td> </tr> <tr> <td>Update Server</td> <td>Factory Defaults</td> </tr> </table> <p>3. Select “Register Device With PIN”. Enter a 4-digit alphanumeric PIN number (provided by your Central Station, your dealer or an authorized AlarmNet representative) on the displayed keypad then select “Done”. (Refer to the table below for applicable registration messages.)</p> <p>Note: <i>Register Device With PIN</i> can be cancelled by selecting “Cancel”. The registration process is aborted and the message Registration Cancelled! is displayed.</p>	Register Device	Register Device With PIN	Update Server	Factory Defaults		
Register Device	Register Device With PIN						
Update Server	Factory Defaults						

During the registration process the following messages may be displayed:

Message	Meaning
Registering...	The registration message is sent and the unit is waiting for the acknowledgement.
Registration Successful!	The PIN number is valid and module is registered and is now in full service and available for alarm reporting to the Central Station. The old module is unregistered. Additionally, AlarmNet sends a substitution alarm to the Central Station.
Registering – Try Later!	Error Message indicates the module is busy.
Registration Failed!	Error message followed by one of the messages below:
Invalid Configuration!	Indicates the configuration is invalid.
Timed Out.	Displayed if no response to the registration request is received.
Primary ID – Need PIN.	Indicates PIN that was entered is invalid.

Programming the Control

Update Server

This procedure is used to upload the Configuration File to the Server.

SCREEN	ACTION									
Comm. Diagnostics	<p>1. Select "Comm. Diagnostics" The System displays the following options depending upon the communication device that is installed:</p> <table border="0" style="width: 100%; text-align: center;"> <tr> <td style="width: 33%;">WiFi Location None</td> <td style="width: 33%;">Configure WiFi</td> <td style="width: 33%;">Ethernet Information</td> </tr> <tr> <td></td> <td></td> <td>GSM Information</td> </tr> </table> <p>Use the down ▼ arrow to scroll to the next page of options. Use the ▲ arrow to return to the previous page:</p> <table border="0" style="width: 100%; text-align: center;"> <tr> <td style="width: 33%;">Communication Status</td> <td style="width: 33%;">Test Communication</td> <td style="width: 33%;">Setup Communication Communication ID Numbers</td> </tr> </table>	WiFi Location None	Configure WiFi	Ethernet Information			GSM Information	Communication Status	Test Communication	Setup Communication Communication ID Numbers
WiFi Location None	Configure WiFi	Ethernet Information								
		GSM Information								
Communication Status	Test Communication	Setup Communication Communication ID Numbers								
Setup Communication	<p>2. Select "Setup Communication". The System advances to the Registration screen and the following options are displayed:</p> <table border="0" style="width: 100%; text-align: center;"> <tr> <td style="width: 50%;">Register Device</td> <td style="width: 50%;">Register Device With PIN</td> </tr> <tr> <td>Update Server</td> <td>Factory Defaults</td> </tr> </table> <p>3. Select "Update Server" and select "Yes" when the confirmation screen appears. The device uploads its entire configuration file to the server. Selecting "No" will cancel the operation. (Refer to the table below for applicable registration messages.)</p>	Register Device	Register Device With PIN	Update Server	Factory Defaults					
Register Device	Register Device With PIN									
Update Server	Factory Defaults									

During the upload process the following messages may be displayed:

Message	Meaning
Updating Root File...	The root file is being uploaded.
Programming Done	Indicates the root file has been successfully uploaded.
Updating Configuration – Try Later!	Error message indicates the module is busy
Cannot Upload – Try Later!	Error message indicates the communication path(s) is not available.
Update Root File – Failed!	Error message indicates an error while uploading root file.

Enroll the L5100-WiFi Module

The module can be enrolled using one of the following procedures:

- Scan Access Points
- Manual Configure Access Points
- WPS

SCREEN	ACTION									
Comm. Diagnostics	<p>1. Select "Comm. Diagnostics" The System displays the following options depending upon the communication device that is installed:</p> <table border="0" style="width: 100%; text-align: center;"> <tr> <td style="width: 33%;">WiFi Location None</td> <td style="width: 33%;">Configure WiFi</td> <td style="width: 33%;">Ethernet Information</td> </tr> <tr> <td></td> <td></td> <td>GSM Information</td> </tr> </table> <p>Use the down ▼ arrow to scroll to the next page of options. Use the ▲ arrow to return to the previous page:</p> <table border="0" style="width: 100%; text-align: center;"> <tr> <td style="width: 33%;">Communication Status</td> <td style="width: 33%;">Test Communication</td> <td style="width: 33%;">Setup Communication Communication ID Numbers</td> </tr> </table>	WiFi Location None	Configure WiFi	Ethernet Information			GSM Information	Communication Status	Test Communication	Setup Communication Communication ID Numbers
WiFi Location None	Configure WiFi	Ethernet Information								
		GSM Information								
Communication Status	Test Communication	Setup Communication Communication ID Numbers								

Programming the Control

SCREEN	ACTION
<div style="border: 1px solid black; padding: 5px; width: fit-content;"> WiFi Location None </div>	2. Select “WiFi Location”. The System will scroll between “None” and “Speaker Side”. After selecting “Speaker Side”, the “Configure WiFi” option will be displayed. 3. Select “Configure WiFi”. The following options will be displayed: Scan Access Points Manually Configure AP WPS

Enroll using Scan Access Points

Note: If the preferred access point is not available after scanning, manually select the network via the “Manually Configure Access Points” procedure.

1. Select “Scan Access Points”. The available networks and signal strength are displayed. Use the down ▼ arrow to scroll to the next page of options. Use the ▲ arrow to return to the previous page.

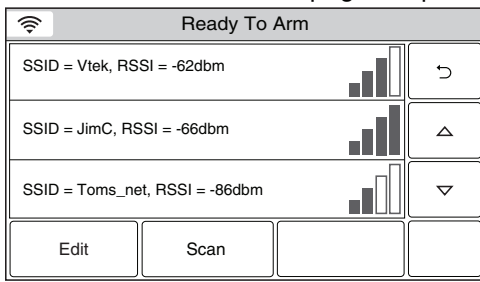

2. Select the desired Network and then press the “Edit” button.
3. Select “Key” and enter the network password on the displayed keypad. The network information is displayed. Select Done.
4. Select the “Join” button. A confirmation screen will be displayed.
5. Select “OK”, then select “Save” to confirm the selection.
6. Select the “↶” button two times. The Ethernet information will be displayed. Signal strength will be indicated by a series of colored bars along with the RSSI level (in dBm).

Bars	Meaning	RSSI range (dBm)
4 White	No connection	-255 (used internally)
1 Yellow, 3 White	Weak	-81 or higher
2 Yellow, 2 White	Fair	-71 to -80
3 Yellow, 1 White	Good	-51 to -70
4 Yellow	Excellent	-50 or less

Manually Configure Access Points

Note: For WEP Security type, the LYNX Touch supports the Key Index 1 in open system authentication mode.

1. Select “Manually Configure AP”, the following screen is displayed.

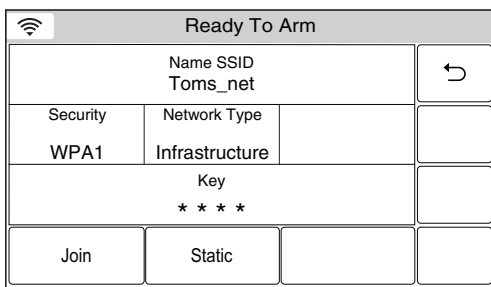

2. Select “SSID Name” and then enter a name (not to exceed 31 characters) on the displayed keyboard.
3. Select “Security”. The system scrolls between the following options:
 Open
 WPA1
 WPA2
 WEP When configuring for WEP encryption key on the access point, always use hexa-decimal type as the input method.
4. Select “Network Type”. The system scrolls between “Infrastructure” and “Ad-Hoc”.

Programming the Control

5. Select "DHCP". The system scrolls between "Yes" and "No". If "No" is selected the "Static" button is displayed.
Note: When entering a password, up to 31 characters can be entered. The system will only display the first 22 characters but will accept up to 31.
6. If a password is required, select "Key" and enter the password.
7. Select the "Static" button and go to step 8.
8. Select each of the following and enter the required information on the displayed keyboard:
 IP Address (Enter the 4-part address)
 Subnet Mask (Enter the 4-part address)
 Gateway IP Address (Enter the 4-part address)
 DNS Server IP Address (Enter the 4-part address)
9. Select "Save" when complete. Pressing "Save" will cause the panel to automatically attempt to join the configured access point every time the system is powered up.
10. Select "Join" when ready to connect with the access point. If the panel joins the access point successfully, it will automatically attempt to join this access point again on power up.

WiFi Protected Set-up (WPS)

Note: For WPS operation, press the WPS button on the access point first. Then press the WPS button within 2 minutes

1. Select "WPS", the system displays "Please Stand-by for WPS Operation...".
2. If the operation is successful the system displays "Device has been successfully added to the network." Select "OK".
3. If the operation is unsuccessful the system displays "Failed Operation. Device not added to the network." Select "OK".

Factory Defaults

This procedure resets the programming options to factory-default values.

SCREEN	ACTION						
Comm. Diagnostics	1. Select "Comm. Diagnostics" The System displays the following options depending upon the communication device that is installed: <table style="width: 100%; border-collapse: collapse;"> <tr> <td style="text-align: center; width: 33%;">WiFi Location None</td> <td style="text-align: center; width: 33%; border-left: 1px solid black;">Configure WiFi</td> <td style="text-align: center; width: 33%; border-left: 1px solid black;">Ethernet Information GSM Information</td> </tr> </table> Use the down ▼ arrow to scroll to the next page of options. Use the ▲ arrow to return to the previous page: <table style="width: 100%; border-collapse: collapse;"> <tr> <td style="text-align: center; width: 33%;">Communication Status</td> <td style="text-align: center; width: 33%; border-left: 1px solid black;">Test Communication</td> <td style="text-align: center; width: 33%; border-left: 1px solid black;">Setup Communication Communication ID Numbers</td> </tr> </table>	WiFi Location None	Configure WiFi	Ethernet Information GSM Information	Communication Status	Test Communication	Setup Communication Communication ID Numbers
WiFi Location None	Configure WiFi	Ethernet Information GSM Information					
Communication Status	Test Communication	Setup Communication Communication ID Numbers					
Setup Communication	2. Select "Setup Communication". The System advances to the Registration screen and the following options are displayed: <table style="width: 100%; border-collapse: collapse;"> <tr> <td style="text-align: center; width: 50%;">Register Device</td> <td style="text-align: center; width: 50%; border-left: 1px solid black;">Register Device With PIN</td> </tr> <tr> <td style="text-align: center;">Update Server</td> <td style="text-align: center; border-left: 1px solid black;">Factory Defaults</td> </tr> </table> 3. Select "Factory Defaults" and select "Yes" when the confirmation screen appears. The device is reset to factory default values. Selecting "No" will cancel the operation. (Refer to the table below for applicable registration messages.)	Register Device	Register Device With PIN	Update Server	Factory Defaults		
Register Device	Register Device With PIN						
Update Server	Factory Defaults						

The following messages may be displayed:

Message	Meaning
Default Configuration – Successful!	Indicates all programmed values are reset to the original factory settings.
Default Configuration Failed – Access Denied	Error message indicates the device does not have local programming access.
Default Configuration – Try Later!	Error message indicates the module is busy.

Remote Programming/Control (Downloading)

General Information

The Control Panel can be remotely programmed from an IBM-compatible Personal Computer (PC), Compass Downloader, a HAYES compatible Modem (L5210/L5210CN only) or via a capable GSM or IP Communications Module. When connected to the COMPASS Downloader – “SERVICE UPDATE” appears on touch screen.

UL Downloading may only be performed if a technician is at the site.

Multiple security levels protect remote programming against compromise by attempts to defeat the system.

1. **Security Code Handshake:** A download ID code is verified for authenticity before connection is established.
2. **Site-Initiated Remote Programming:** The installer initiates downloading by selecting the “Initiate Download” button on the Installer programming screen.
3. **Station-Initiated Remote Programming:** The operator calls the site from your office to initiate the download call. The Control hangs up and then calls back the PC via the preprogrammed telephone number. The unit can then be uploaded, downloaded, or controlled from your office.
4. **Data Encryption:** Data passed between the PC and the Control is encrypted for security so that it is very difficult for a foreign device tapped into the phone line to take over communication and substitute system-compromising information.

Equipment required to download to a system at the premises

- Compass Downloader for Windows (at revision level supporting LYNX Touch).

Flexible Callback: If enabled in Installer Programming, the download operator can temporarily change the last 1, 2, or 3 digits (depending on selection) of the call back number. This allows the control to call back a computer other than the one programmed, which may be helpful at times of high computer traffic.

Remote Programming Information



If using Remote Programming, the LYNX Touch must be connected to the telephone line, GSM Cellular or to the Internet, as applicable.

The downloading system can perform many functions when in communication with the Control. Besides uploading and downloading, the status of the system can be observed and various commands can be initiated, as follows:

- Arm the system in the away mode; disarm the system.
- Bypass a zone.
- Force the system to accept a new program download.
- Shut down communication functions (for nonpayment of monitoring fees in an owned system).
- Shut down all security system functions (for nonpayment for a leased system).
- Inhibit local keypad programming (prevents account takeover).
- Command the system to upload a copy of its resident program to the office.
- Set the time
- View/Modify
- Read: arming status, AC power status, lists of faulted zones, bypassed zones, zones currently in alarm, zones currently in trouble, and RF sensors with low battery conditions; read control’s time.

- Notes:** (1) After the control and the PC have established valid communication, “Service Update” will be displayed on the LCD.
- (2) The detailed operation of the download functions is covered in the installation instructions for the Compass Downloader for Windows.

Remote Programming/Control (Downloading)

Remote Programming Advisory Notes

- A copy of the program downloaded may be printed using the IBM PC-compatible computer's internal report generator, when an optional printer is connected (consult your PC manual for proper printer and connections).
- The approximate time for program upload or download for a complete program is shown below:

Communication Method	Approximate Time
PSTN*	380 secs.
GSM	75 secs.
IP or WiFi	30 secs.

* Not applicable to the LYNX Touch L7000/L7000CN

System Operation

Key/Touchscreen Operation

The keys and touchscreen allows the user to arm and disarm the system, and perform other system functions, such as bypassing zones. Zone and system conditions (ALARM, trouble, bypass) are displayed on the display. When an alarm occurs, console sounding and external sounding will occur, and the zone(s) in alarm will be displayed on the display. Pressing any key will silence the keypad sounder for 10 seconds (only once). Disarming the system will silence both console and external sounders. When the system is disarmed, any zones that were in an alarm condition during the armed period will be displayed (memory of alarm). To clear this display, simply repeat the disarm sequence by pressing the OFF key and entering the Security Code. The console also features chime annunciation, and three panic key icons for silent, audible, fire or personal emergency alarms. These keys can notify the Central Station of an alarm condition, if that service is connected.

Panic Key/Icons

There are three panic key icons that, if programmed, are displayed on the virtual keypad when the “PANIC” key is depressed for four seconds. The panic key screen will timeout if a selection is not made within ten seconds. The keys can be used to manually initiate alarms and send a report to the Central Station. Each can be individually programmed for 24-hour silent, audible, personal or fire emergency responses. The panic function is activated when the respective keys is pressed. The panic functions are identified by the system as follows:

Zone	Function
95	Fire Emergency
96	Medical Emergency
99	Police Emergency

Important: For the silent panic functions to be of practical value, the system must be connected to a Central Station.

Security Codes

Installer Code

The installer programs the 4-digit Installer Code initially as part of the programming procedure. The factory default Installer Code is **4-1-1-2**, but may be changed in the Installer Code programming field. The Installer Code is the only code that allows entry into Installer Programming mode.

Master Code

In normal operation mode, the Master Code is used to enter the 4-digit User Security Codes.

Enter/Change the Master Code by installer.

The factory default Master Code for the LYNX Touch Control is set to 1-2-3-4. The Master Code is used to enter the 4-digit User Security Codes.

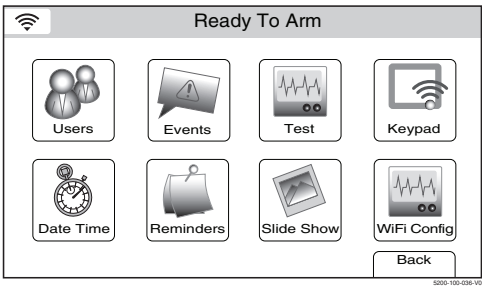
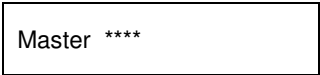
SCREEN	ACTION
	<ol style="list-style-type: none"> 1. After entering the User Tools/Programming Menu, select the “Users” icon on the User Menu screen. The system displays the User Code Programming screen
	<ol style="list-style-type: none"> 3. Select “Master”, then select “Edit”. 4. Enter a new four-digit Master Code on the displayed keypad The system will display the new code on the left side of the screen. 5. Select “Done” when you are finished. 6. The system returns to the User Code Programming screen.

System Operation

Secondary User Codes

In normal operation mode, the Master Code can be used to assign up to 30 (L5210/L5210CN) or 46 (L7000/L7000CN) secondary 4-digit security codes, including a Guest Code and a Duress Code. The Master Code can also be used to remove secondary codes from the system (individually). Refer to the LYNX Touch User Manual for additional information.

Reset Master Code

1. After Entering the Installer Programming Mode, select “Reset Master Code” from the second page of the Installer Programming Tools menu.
2. The system displays a confirmation screen. Select the “Yes” key to reset the Master Code to “1234”.
3. If confirmed, the Master Code will be reset back to “1-2-3-4”. This will be logged in the System Event Log as “Reset Master Code User 2 E655”. The system returns to the second page of the Installer Programming Tools menu. OR

If the reset failed, the system will display: “Command Failed. Unable to Reset Master Code”.

Security Code Notes

- The Master and Secondary security codes permit access to the system for arming, disarming, etc.
- The Installer Code can disarm the system only if it was used to arm it. In addition, the Installer Code cannot disarm the system if it was armed by pressing and holding a Quick-Arm button.
- The Babysitter Code can disarm the system only if it was used to arm it. In addition, the Babysitter Code cannot disarm the system if it was armed by pressing and holding a Quick-Arm button.
- Duress code sends a special code to the Central Station when used to perform any system operation. Instruct users to be careful not to use this code for normal usage.
- Opening/closing reports are sent for the Installer Code, with the appropriate subscriber number. Master Code and secondary User 2 and 3-32 (L5210/L5210CN) or 3-48 (L7000/L7000CN), respectively, in Contact ID® format (with the appropriate User Code number).

System Operation

“Follow Me” System Announcement Feature (L5210/L5210CN Only)

This feature allows the LYNX Touch to deliver a voice system message to the Follow Me Phone numbers programmed by the installer. The LYNX Touch will first transmit reports to the Central Station and after receiving its kiss-off, the system will dial the user phone numbers and begin transmitting the welcome message “System Message, Press Star to Play”. The system will dial the user phone numbers a maximum of eight times.

The “Follow Me” System announcements feature is only supported if a PSTN line is available. The announcements are individually sent to the phone numbers, which are programmed as Follow Me Phone 1 and Follow Me Phone 2 respectively in the Reporter Programming section. System Follow Me announcements are triggered by a system event that belongs to one of the Event Groups enabled by Installer individually for the programmed phone number(s). The groups are listed below.

- All Bypassing actions by a user
- Any Open/Close (arming/disarming status changes)
- Any Alarms
- Any Alarm Restores
- Alarm Cancel by the user
- Any System Troubles
- Any Test
- Non-security Events

If the “*” key is not pressed, LYNX Touch will announce “System message Press * to Play” for 45 seconds before hanging up and redialing the programmed number. The control will make eight attempts before unsuccessfully ending the System “Follow Me” session and erasing all the events in the queue. The next call will be triggered by a new event from the Event Group enabled for the programmed number(s).

If the “*” key is pressed, LYNX Touch will play back a sequence of System “Follow Me” announcements from the queue in chronological order starting with the oldest one. The announcements will include “End of Message” at the end of the “Follow Me” announcements.

If the “*” key is pressed again during playback or within 15 seconds following the end of the playback, the control will repeat the sequence. Otherwise the system will hang up, successfully ending the System “Follow Me” session. Because the “*” key was pressed LYNX Touch will not redial the number again. The next call will be triggered by a new event from the Event Group enabled for the programmed number(s).

Note: The follow me system announcement will be terminated if any other event requires the system to send a report to the Central Station. Once the PSTN line is available the session will be resumed and the control will again make up to 8 delivery attempts.

Follow Me Event Triggers	Follow Me Announcement
AC Loss	AC Loss
Audible Panic	Panic Alarm
Automatic Disarmed	Disarmed
Battery Failed Under Load	System Low Battery
Burglary Zone Bypass	Zone ** Bypassed
Carbon Monoxide Detected	Carbon Monoxide Alarm
Disarmed From AWAY or STAY	Disarmed
Emergency Alarm	Emergency Alarm
Entry/Exit Alarm	Perimeter Alarm
Exit Error Alarm (zone)	Perimeter Alarm
Expansion Module Tamper	Tamper Alarm
Expansion Module Failure	System Trouble
Expansion Module Tamper Alarm	Tamper Alarm
Expansion Module Tamper Trouble	Tamper Alarm
Fire Alarm	Fire Alarm
Fire Trouble	System Trouble

Follow Me Event Triggers	Follow Me Announcement
Interior Alarm	Interior Alarm
Keypad Panic	Panic Alarm
Manual Test	System Test
Medical Alarm	Emergency Alarm
Perimeter Alarm	Perimeter Alarm
Remote Disarm	Disarmed
RF Sensor Lost	System Trouble
Sensor Low Battery or Tamper	Sensor Trouble
Silent Burglary	Silent Burglary
Siren Tamper	Tamper Alarm
System Inactivity	No Check In
System Low Battery	System Low Battery
Water Leakage Alarm	Auxiliary Alarm
Zone Bypass	Zone ** Bypassed
Zone Tamper (Alarm)	Tamper Alarm
Zone Trouble	System Trouble

** = Zone Number

“Follow Me” Reminder Feature (L5210/L5210CN Only)

The “Follow Me” feature allows the user to schedule a time driven message. When activated, the system will dial the Follow Me Phone 1 and/or the Follow Me Phone 2 telephone numbers, which are programmed by the installer (in the Reporter Programming section), and deliver a recorded message. The LYNX Touch will immediately begin transmitting the voice message and will repeat the message for 45 seconds. If the message has timed out, the system will redial the programmed number a maximum of seven additional times or until it is acknowledged. Selecting “OK” when the confirmation screen is displayed on the LYNX Touch will terminate both the “Follow Me” reminder and the local reminder announcements.

- Notes:**
- (1) This feature is only supported if it has been programmed.
 - (2) The follow me reminder will be terminated if any other event requires the system to dial out, however, delivery of the local schedule reminder message will continue.
 - (3) If a Central Station report must be sent, the “Follow Me” Reminder message will be suspended. Once the PSTN line is available the session will be resumed and the control will again make up to 8 delivery attempts.

Remote Phone Control Feature (L5210/L5210CN Only)

The remote phone control feature, which must be enabled, allows the user to access the security system from any off-site touch-tone telephone. The control will pick up the incoming call, based on the specified ring count, and will announce “SYSTEM ENTER CODE” every three seconds for the next nine seconds. During this period the panel will wait for a valid User Code to be entered. If a valid User Code is not entered or the nine second period expires a modem tone will be generated for remote programming (Compass Downloading). If a valid User Code has been entered, the control will announce the current system status and/or beeping sounds. Refer to the User Guide for additional information regarding this feature.

System Operation

System Displays

The following icons will be displayed on the Home screen along with specific zone status information (if applicable) to indicate system status.

DISPLAY	DEFINITION
	AC Loss
	Alarm (intrusion)
	Armed Away
	Armed Stay
	Battery Low
	Check Zones
	CO Alarm
	Disarmed Not Ready to Arm
	Disarmed Ready to Arm
	90 RF Jam
	94 Phone Line Cut
	103 Comm. Trouble

DISPLAY	DEFINITION
	Door Open
	Window Open
	Exit Active
	Fire OR Heat Sensor
	Flood
	Glass Break
	Medical Alarm
	Motion
	Temperature
	Cover Tamper
	Reporter Failure
	Automation (Z-Wave Node Failure)

DISPLAY	DEFINITION
	Fault * Garage Door
	WiFi source present and signal strength
	No WiFi source

Zone Status Displays

The following icons will be displayed on the Zone Status screen along with specific zone status information when a zone has been Faulted, Bypassed or in Alarm.

DISPLAY	DEFINITION
	Alarm
	Fault (Yellow)

DISPLAY	DEFINITION
	Ready
	Trouble (red)

DISPLAY	DEFINITION
	Bypass

UL Audio alarm verification has not been evaluated by UL.

Audio Alarm Verification (Two-Way Voice Feature)

This feature allows the Central Station operator to listen, talk to or conduct a two-way conversation with an individual(s) at the premises. It also assists the operator in gathering information about the nature and location of the alarm that may be helpful in responding to police and fire departments. All LYNX Touch Control Panels are capable of supporting the Two-Way Voice feature. The LYNX Touch does not make system announcements when the Two-Way Voice feature is active.

If a WiFi connection is being used for Two-Way Voice (AAV), sufficient bandwidth must be available.

- AAV requires a continuous WiFi upload/download bandwidth of 90kbps for proper operation.
- WiFi bandwidth less than 90kbps may result in degraded performance.

Activation



Fire and CO alarms will prevent the LYNX Touch from starting an AAV session. A new Fire or CO alarm will end an AAV session that is in progress.

The LYNX Touch sends the “alarm message” followed by a “Listen-in-to-Follow message” (Contact ID® code 606) to the Central Station. The Listen-in-to-Follow message causes the Central Station’s digital receiver to temporarily hold the phone line for approximately 1 minute. When the LYNX Touch receives the “kissoff” from the Central Station, indicating that the alarm message has been received, the Two-Way Voice (AAV) feature is activated in the (default) “Listen Mode” and sirens and keypad sounds are discontinued. The LYNX Touch transmits a beep acknowledgment to the Central Station, once per second. The beep alternates between two tones and indicates that the LYNX Touch is waiting for a session command from the Central Station operator. Once a command is issued the beep acknowledgement is discontinued. If a command is not issued within two minutes the system will “time out” and the call will be terminated.

Operator Commands

The Central Station operator begins the session, which last 5 minutes, by entering one of the valid AAV commands shown in the table below. The session may be extended 5 minutes, without changing the operating mode, by pressing the [7] key on the touch-tone phone. Selecting another operating mode also resets the session an additional 5 minutes. During the last minute of the 5 minute, session, the LYNX Touch generates two beeps every 30 seconds to alert the Central Station operator that the session is about to time out. The Central Station operator may then extend the session by pressing the [7] key on the touch-tone phone. If the session is not extended, the phone line is disconnected and the session is ended. Sessions may be ended at any time by pressing the [9] key on the touch-tone phone. The AAV modes are described as follows:

Note: When entering AAV commands make sure the Central Station receiver has been disconnected from the phone line, otherwise AAV commands may not go through.

Key	Function
1	Talk Mode: Pressing the [1] key on the touch tone phone, enables one-way voice communication from the Central Station to the violated premises, and allows the operator to communicate through the built-in speaker on the LYNX Touch. In this mode the “Panic” function key is lit Red and the “Home” function key is alternately lit Red and Green.
2	VOX (Voice) Mode: Pressing the [2] key on the touch-tone phone, enables two-way voice communications between the Central Station and the violated premises via the built-in speaker and microphone on the LYNX Touch. In this mode the “Panic” function key is lit Red and the “Home” function key is alternately lit Red and Green.
3	Listen Mode: Pressing the [3] key on the touch-tone phone, Enables one-way audio from the violated premises to the Central Station. The Listen Mode is the start up default mode of the voice feature and allows the operator to listen through the LYNX Touch microphone. In this mode the “Panic” function key is lit Red and the “Home” function key is alternately blinks Green and off.
7	Extends the session 5 minutes without changing its operating mode.
9	Ends the session and disconnects the phone line.

System Operation

Event Log

The LYNX Touch Series event log is capable of recording and displaying up to 128 (L5210/L5210CN) or 256 (L7000/L7000CN) system events. The type of events that can be recorded is selectable and is programmed in the System Type programming field. The event log can be reviewed by entering the Installer Programming or Master User Programming mode and selecting “Events”. Refer to the LYNX Touch L5210 or L7000 Series User Manual for additional information. The Events and CID or SIA Codes that are displayed in the Event Log vary between the LYNX Touch L5210/L5210CN and L7000/L7000CN controls, according to the options that are programmed. The table below provides definitions of the events/codes that may be displayed by the panel.

Note: In the unlikely condition that the backup battery becomes fully discharged when AC power is lost, any system activity performed after the low battery notification will not be saved in the event log. Additionally, the panel will revert to the status condition as before the low battery notification.

Contact ID® & SIA Event Log Codes

CID Code	Definition
110	Alarm, Fire
121	Alarm, Duress
122	Alarm, Silent
123	Alarm, Audible
131	Alarm, Perimeter
132	Alarm, Interior
134	Alarm, Entry/Exit
135	Alarm, Day/Night
137	Alarm, Tamper
145	Expansion Module Tamper
146	Silent Burglary
150	24-Hour Non-Burglary
162	Carbon Monoxide Detected
301	Trouble, AC Loss
302	Trouble, Low System Battery
305	Trouble, System Reset
316	System Tamper*
341	Trouble, Case Tamper
344	Trouble, RF Receiver Jam Detect
351	Trouble, Telco 1 Fault
353	Trouble, Long Range Radio Transmitter Fault
373	Trouble, Fire Trouble
374	Trouble, Exit Error Alarm
380	Trouble, Sensor
381	Trouble, Loss of Supervision RF
383	Trouble, Sensor Tamper
384	RF Low Battery
401	Open/Close by User
403	Open/Close Automatic
406	Cancel
407	Remote Arm/Disarm
408	Quick Arm
441	Armed Stay
455	Auto-Arm Failed
459	Recent Close
570	Zone/Sensor Bypass
601	Manual Trigger Test Report
602	Periodic Test Report
606	Listen-in to follow
607	Walk Test
623	Event 90% Full
627	Program Mode Entry (Logged in Event Log Only)
628	Program Mode Exit (Logged in Event Log Only)
654	System Inactivity
655	Reset Master Code (Logged in Event Log Only)
759	Resident Monitor Zone Response
760	Resident Response Zone Response
761	General Monitor Zone Response
762	General Response Zone Response

SIA Code	Definition
AT/AR	AC Trouble/AC Restoral
BA/BR	Burglary Alarm/Burglary Restoral
CA/CD	Automatic Closing/Closing Delinquent
CI	Fail to Close (Log only)
CL	Closing Report
CQ	Remote Closing
CR	Recent Closing
DF/DR	Door Forced/Door Restoral
EA	Exit Alarm
ES/EJ	Expansion Device Tamper/Expansion Tamper Restore
ET	Expansion Trouble
FA	Fire Alarm
FT/FJ	Fire Trouble/Fire Trouble Restore
HA/HR	Holdup Alarm/Holdup Restoral
GA/GR	Gas Alarm/Gas Restoral
FT/FJ	Fire Trouble/Fire Trouble Restore
LT/LR	Phone Line Trouble/Phone Line Restoral
OA	Automatic Opening
OC	Cancel Report
OP	Opening Report
OQ	Remote Opening
PA	Panic Alarm
RP	Automatic Test
RX	Manual Test
TA/TH	Tamper Alarm/Tamper Alarm Restore
TJ	Tamper Trouble Restore
TS/TE	Test Start/Test End
TT	Tamper Trouble
UA	Untyped Zone Alarm
UB/UU	Untyped Zone Bypass/Untyped Zone Unbypass
UT/UJ	Untyped Zone Trouble/Restore
XG/XH	RF Interference/RF Interference Restore
XT/XR	Transmitter Battery Trouble/Transmitter Battery Restoral
YT/YR	System Battery Trouble/System Battery Restoral

*If APL is enabled, AlarmNet will generate a special comm. fail message (E316) if it does not hear from a unit within 15 minutes after a delayed alarm is delivered. This message is meant to alert the Central Station that the system has been tampered with and may have been compromised.

System Operation

Central Station Messages

The following messages are sent by the communications modules (4GL/4GLC or 3GL/3GLC, ILP5 and L5100-WiFi) for the conditions listed below.

Alarm Condition	Alarm Code	Restore Code
Power On / Reset	E339 C0803	
Primary Communication Path Supervision	E350 C0951	R350 C0951
Secondary Communication Path Supervision	E350 C0952	R350 C0952
Test	5555 5555 9	

The Control Panel sends its own general code (E353) for a trouble condition. The Control panel sends tamper trouble (E341), tamper alarm (E145), power loss (E301) and low battery (E302) messages.

Testing the System

TO THE INSTALLER

Regular maintenance and inspection (at least annually) by the installer and frequent testing by the user are vital to continuous satisfactory operation of any alarm system.

The installer should assume the responsibility of developing and offering a regular maintenance program to the user as well as acquainting the user with the proper operation and limitations of the alarm system and its component parts. Recommendations must be included for a specific program of frequent testing (at least weekly) to ensure the system's proper operation at all times.

Test Modes

The "Test" button provides access to the following functions and test modes:

Option	Function
Walk Test	Refer to the User Manual for additional information
RF Sniffer Test	Refer to the <i>Installing Wireless Zones</i> section of this manual for additional information.
Go-No-Go Test	Refer to the <i>Installing Wireless Zones</i> section of this manual for additional information.
Dialer Test	Refer to the to the paragraph in this section and the User Manual for additional information. Note: This test is not available on the LYNX Touch L7000/L7000CN.
Zone Discovery	Provides access to Zone Discovery. Refer to the paragraph in this section for additional information regarding the Zone Discovery feature.
Diagnostics	Provides access to the Reboot Feature and Web Content Usage. Refer to the paragraph in this section for additional information regarding these features.

Testing the System

After installation is completed, the security system should be carefully tested, as follows:

1. With the system in the disarmed state, check that all zones are intact. If the "Panic" or "Home" function key is not lit, select the Zones icon to display the faulted zone(s). If necessary, restore faulted zone(s) so that the "Panic" or "Home" function key lights. Fault and restore every sensor individually to assure that it is being monitored by the system.

Armed System Test

Alarm messages will be sent to the Central Station during the following tests 1 and 2. **Notify the Central Station in advance that tests will be in progress.**

1. Arm the system and fault one or more zones. After 15 seconds (if optional dialer delay is selected), silence alarm sounder(s) by disarming the system. Check entry/exit delay zones.
2. Check the keypad-initiated alarms by selecting the Panic key. If the system has been programmed for audible emergency, the keypad will emit a steady alarm sound, and "ALARM" and zone number will be displayed. For L5210/L7000 configuration, silence the alarm by entering the Security Code. For L5210CN/L7000CN, silence the alarm by pressing the Home key and entering the Security Code.

If the system has been programmed for silent emergency, there will be no audible alarms or displays, but a report will be sent to the Central Station.

3. Notify the Central Station when all tests are finished, and verify results with them.
4. To test the wireless part of the system and the RF receiver, perform the two additional tests described in the *Installing Wireless Zones* section: Sniffer mode and Go-No-Go Test.

Note: System Test mode and Go-No-Go Test will be automatically terminated after 3-1/2 to 4 hours if the installer or user does not manually terminate it. This ensures that fire and panic zones will not remain disabled. However, Sniffer mode does not automatically expire. You must manually exit Sniffer mode (by depressing the Home key and entering the Master Code) to return to normal operation. During the final 5 minutes, the system will emit double beeps indicating that the end of Test mode is nearing.

Testing the System

Dialer Test

Note: This test is not available for the LYNX Touch L7000/L7000CN.

The Dialer Test checks that the phone connection to the Central Station is working properly. **Notify the Central Station in advance that tests will be in progress.**

1. With the System in the Installer Programming mode, select the “Test” button and then select the “Dialer Test” button.
2. If the test is successful the system will send the Manual Trigger Test Report (E601) to the Central Station. The test will not be recorded in the Event Log.
3. The system will make eight attempts to test the dialer for the Primary and eight attempts to test the Secondary Central Station. If the test is unsuccessful the system will display a “Reporter Failure” trouble message after 9-17 minutes.

Zone Discovery Mode



Zone Discovery mode requires Installer supervision when in use. The system is not fully operational for fire or life safety while Zone Discovery Mode is active.

Zone discovery mode can be used to remotely view all zones that have been programmed in the system for operation. The zones must have a response type programmed and in the case of RF zones, must also have a serial number programmed. All zones programmed (except for duress) will be displayed.

Enter Zone Discovery

1. With the System in the Installer Programming mode, select the “Test” button and then select the “Zone Discovery” button. The “Zone Discovery” button will be highlighted indicating that the mode is active.

Exit Zone Discovery

1. Select the Home key and enter the Installer Code. If you do not exit zone discovery mode manually, the system will automatically exit zone discovery mode in approximately 1-4 minutes dependent upon the number of zones that are programmed. The system beeps once and returns to the home screen.

Rebooting the System

The Reboot function allows you to restart the system if required. To reboot the system perform the following:

1. With the System in the Installer Programming mode, select the “Test” button and then select the “Diagnostics” button.
2. The system advances to the next screen. Select the “Reboot” button. A confirmation screen appears.
3. Select “Yes”. The system will restart.

Note: After the reboot sequence is complete it is recommended that you perform a “Walk Test” to verify that all transmitters are operational in the system.

Web Content Usage

This feature is used for internal diagnostics and troubleshooting.

LYNX Touch (L5210/L7000) Programming Default Values

Program Function	Configuration 1	Configuration 2	Configuration 3	Configuration 4
Installer Code	4112	4112	4112	4112
System Type				
RF Jam	Disabled	Disabled	Disabled	Disabled
Speaker Phone (L5210 only)	Disabled	Disabled	Disabled	Disabled
Two Way Voice	Disabled	Disabled	Disabled	Disabled
RF House Code	0	0	0	0
Phone Notification (L5210 only)	Disabled	Disabled	Disabled	Disabled
Remote Phone (L5210 only)	Enabled	Enabled	Enabled	Enabled
Phone Detect Time (L5210 only)	2 Minutes	2 Minutes	2 Minutes	2 Minutes
Events - Log All	Log All Set	Log All Set	Press To Log All	Press To Log All
Events - Log Alarm	Enabled	Enabled	Enabled	Enabled
Events - Log Bypass	Enabled	Enabled	Disabled	Disabled
Events - Log Open/Close	Enabled	Enabled	Disabled	Disabled
Events - Log Trouble	Enabled	Enabled	Enabled	Enabled
Non Security	Enabled	Enabled	Disabled	Disabled
Remote Access Serial	Disabled	Disabled	Disabled	Disabled
Multi Mode Serial	Disabled	Disabled	Disabled	Disabled
Date Time				
Calendar	January 1, 2014	January 1, 2014	January 1, 2014	January 1, 2014
Enter Time	10:00AM	10:00AM	10:00AM	10:00AM
Time Zone	Eastern (EST)	Eastern (EST)	Eastern (EST)	Eastern (EST)
Day Light Savings time	Yes	Yes	Yes	Yes
Start Month	March	March	March	March
Start Week	Second	Second	Second	Second
End Month	November	November	November	November
End Week	First	First	First	First
Communicator				
Communications Path	None	None	None	None
APL	Disabled	Disabled	Disabled	Disabled
City ID	None	None	None	None
CS ID	None	None	None	None
Sub ID	None	None	None	None
Supervision	24 Hours	24 Hours	24 Hours	24 Hours
Old Alarm Time	10 Minutes	10 Minutes	10 Minutes	10 Minutes
Remote Acc. Comm.	Disabled	Disabled	Disabled	Disabled
Multi Mode Comm.	Disabled	Disabled	Disabled	Disabled
GSM Fault Time	00	00	00	00
GSM Rollover	No	No	No	No
GSM 24 Hour Test	No	No	No	No
IP Fault Time	00	00	00	00
Use DHCP	Yes	Yes	Yes	Yes
NIC IP Address	255.255.255.255	255.255.255.255	255.255.255.255	255.255.255.255
Subnet Mask	255.255.255.255	255.255.255.255	255.255.255.255	255.255.255.255
Gateway IP Address	255.255.255.255	255.255.255.255	255.255.255.255	255.255.255.255
DNS Server IP Address	255.255.255.255	255.255.255.255	255.255.255.255	255.255.255.255
Zones	See Zone Programming Default Values			
Reporter				
Primary CS info				
Phone Type	Contact Id: 4 Digit	Contact Id: 4 Digit	Contact Id: 4 Digit	Contact Id: 4 Digit
Communicator Type	None	None	None	None
Phone Number	Blank	Blank	Blank	Blank
Account Number	FFFF	FFFF	FFFF	FFFF
Dynamic Priority	None	None	None	None
Dynamic Delay	None	None	None	None
Report All	Press to Report All	Press to Report All	Press to Report All	Press to Report All
Report Alarms	Enabled	Enabled	Enabled	Enabled
Report Troubles	Enabled	Enabled	Enabled	Enabled
Report Open/Close	Disabled	Disabled	Disabled	Disabled
Report Tests	Enabled	Enabled	Enabled	Enabled

LYNX Touch (L5210/L7000) Programming Default Values

Program Function	Configuration 1	Configuration 2	Configuration 3	Configuration 4
Secondary CS info				
Phone Type	None	None	None	None
Communicator Type	None	None	None	None
Phone Number	Blank	Blank	Blank	Blank
Account Number	FFFF	FFFF	FFFF	FFFF
Dynamic Priority	None	None	None	None
Dynamic Delay	None	None	None	None
Report All	Press to Report All	Press to Report All	Press to Report All	Press to Report All
Report Alarms	Enabled	Enabled	Enabled	Enabled
Report Troubles	Enabled	Enabled	Enabled	Enabled
Report Open/Close	Disabled	Disabled	Disabled	Disabled
Report Tests	Enabled	Enabled	Enabled	Enabled
Follow Me Phone 1 (L5210 only)				
Phone Type (L5210 only)	None	None	None	None
Phone Number (L5210 only)	Blank	Blank	Blank	Blank
Report All (L5210 only)	Press To Report All	Press To Report All	Press To Report All	Press To Report All
Report Alarms (L5210 only)	Disabled	Disabled	Disabled	Disabled
Report Troubles (L5210 only)	Disabled	Disabled	Disabled	Disabled
Report Open/Close (L5210 only)	Disabled	Disabled	Disabled	Disabled
Report Tests (L5210 only)	Disabled	Disabled	Disabled	Disabled
Follow Me Phone 2 (L5210 only)				
Phone Type (L5210 only)	None	None	None	None
Phone Number (L5210 only)	Blank	Blank	Blank	Blank
Report All (L5210 only)	Press To Report All	Press To Report All	Press To Report All	Press To Report All
Report Alarms (L5210 only)	Disabled	Disabled	Disabled	Disabled
Report Troubles (L5210 only)	Disabled	Disabled	Disabled	Disabled
Report Open/Close (L5210 only)	Disabled	Disabled	Disabled	Disabled
Report Tests (L5210 only)	Disabled	Disabled	Disabled	Disabled
Report Selection				
Arm Away	Enabled	Enabled	Enabled	Enabled
Arm Stay	Enabled	Enabled	Enabled	Enabled
Disarm	Enabled	Enabled	Enabled	Enabled
Exit Error	Enabled	Enabled	Enabled	Enabled
Recent Closing	Enabled	Enabled	Enabled	Enabled
Event Log Full	Enabled	Enabled	Enabled	Enabled
Trouble	Enabled	Enabled	Enabled	Enabled
Trouble Restore	Enabled	Enabled	Enabled	Enabled
Alarm Restore	Enabled	Enabled	Enabled	Enabled
Alarm Cancel	Enabled	Enabled	Enabled	Enabled
Test	Enabled	Enabled	Enabled	Enabled
Test Restore	Enabled	Enabled	Enabled	Enabled
Bypass	Enabled	Enabled	Enabled	Enabled
Bypass Restore	Enabled	Enabled	Enabled	Enabled
AC Loss	Enabled	Enabled	Enabled	Enabled
AC Loss Restore	Enabled	Enabled	Enabled	Enabled
Low Battery	Enabled	Enabled	Enabled	Enabled
Low Battery Restore	Enabled	Enabled	Enabled	Enabled
RF Low Battery	Enabled	Enabled	Enabled	Enabled
RF Low Battery Restore	Enabled	Enabled	Enabled	Enabled
Options				
PBX (L5210 only)	Blank	Blank	Blank	Blank
Call Wait Cancel (L5210 only)	Blank	Blank	Blank	Blank
Number of Reports	2 Reports	2 Reports	2 Reports	2 Reports
Alarm Report Delay	30 Sec.	30 Sec.	30 Sec.	30 Sec.
First Report Offset	6 Hrs	12 Hrs	12 Hrs	12 Hrs
Report Frequency	Never	30 Days	Never	Never

LYNX Touch (L5210/L7000) Programming Default Values

Program Function	Configuration 1	Configuration 2	Configuration 3	Configuration 4
Downloader				
Phone Answer (L5210 only)	Yes	Yes	Yes	Yes
Ans. Machine Defeat (L5210 only)	Yes	Yes	Yes	Yes
Modem Speed (Future Use)	Slow	Slow	Slow	Slow
Ring Counter	2	2	2	2
Callback Number	Blank	Blank	Blank	Blank
Flexible Callback Number	No	No	No	No
	1	1	1	1
Sounder				
Burglary Alarm Sound	Yes	Yes	Yes	Yes
Burglary Bell Timeout	4 Minutes	4 Minutes	4 Minutes	4 Minutes
Fire Bell Timeout	4 Minutes	4 Minutes	4 Minutes	4 Minutes
Arm Confirm	RF Keyfob	RF Keyfob	RF Keyfob	RF Keyfob
System Settings				
Entry Delay 1	30 Seconds	30 Seconds	30 Seconds	30 Seconds
Entry Delay 2	30 Seconds	30 Seconds	30 Seconds	30 Seconds
Exit Delay	60 Seconds	60 Seconds	60 Seconds	60 Seconds
Backlight Timeout	No	No	No	No
Quick Arm	Yes	Yes	Yes	Yes
Quick Exit	Yes	Yes	Yes	Yes
Restart Exit Time	Yes	Yes	Yes	Yes
Force Bypass	No	No	No	No
Exit Warning	Yes	Yes	Yes	Yes
Auto Stay Arming	Yes	Yes	Yes	Yes
Lack Of Usage Notify	Disabled	Disabled	Disabled	Disabled
Power-Up In Previous	Yes	Yes	Yes	Yes
Display Alarm Cancel	Yes	Yes	Yes	Yes
Display Exit Time	Yes	Yes	Yes	Yes
Cross Zone Delay	None	None	None	None
Cross Zone 1	Disabled	Disabled	Disabled	Disabled
Cross Zone 2	Disabled	Disabled	Disabled	Disabled
Z-Wave				
Z-Wave	Enabled-Installed	Enabled-Installed	Enabled-Installed	Enabled-Installed
Temperature	Fahrenheit	Fahrenheit	Fahrenheit	Fahrenheit

LYNX Touch (L5210CN/L7000CN) Canada Programming Default Values

Program Function	Configuration 1	Configuration 2	Configuration 3	Configuration 4
Installer Code	4112	4112	4112	4112
System Type				
RF Jam	Disabled	Disabled	Disabled	Disabled
Speaker Phone (L5210CN only)	Disabled	Disabled	Disabled	Disabled
Two Way Voice	Disabled	Disabled	Disabled	Disabled
RF House Code	0	0	0	0
Phone Notification (L5210CN only)	Disabled	Disabled	Disabled	Disabled
Remote Phone (L5210CN only)	Enabled	Enabled	Enabled	Enabled
Phone Detect Time (L5210CN only)	2 Minutes	2 Minutes	2 Minutes	2 Minutes
Events - Log All	Press To Log All	Log All Set	Press To Log All	Press To Log All
Events - Log Alarm	Enabled	Enabled	Enabled	Enabled
Events - Log Bypass	Disabled	Enabled	Disabled	Disabled
Events - Log Open/Close	Disabled	Enabled	Disabled	Disabled
Events - Log Trouble	Enabled	Enabled	Enabled	Enabled
Non Security	Enabled	Enabled	Disabled	Disabled
Remote Access Serial	Disabled	Disabled	Disabled	Disabled
Multi Mode Serial	Disabled	Disabled	Disabled	Disabled
Date Time				
Calendar	January 1, 2014	January 1, 2014	January 1, 2014	January 1, 2014
Enter Time	10:00AM	10:00AM	10:00AM	10:00AM
Time Zone	Eastern (EST)	Eastern (EST)	Eastern (EST)	Eastern (EST)
Day Light Savings time	Yes	Yes	Yes	Yes
Start Month	March	March	March	March
Start Week	Second	Second	Second	Second
End Month	November	November	November	November
End Week	First	First	First	First
Communicator				
Communications Path	None	None	None	None
APL	Disabled	Disabled	Disabled	Disabled
City ID	None	None	None	None
CS ID	None	None	None	None
Sub ID	None	None	None	None
Supervision	24 Hours	24 Hours	24 Hours	24 Hours
Old Alarm Time	10 Minutes	10 Minutes	10 Minutes	10 Minutes
Remote Acc. Comm.	Disabled	Disabled	Disabled	Disabled
Multi Mode Comm.	Disabled	Disabled	Disabled	Disabled
GSM Fault Time	00	00	00	00
GSM Rollover	No	No	No	No
GSM 24 Hour Test	No	No	No	No
IP Fault Time	00	00	00	00
Use DHCP	Yes	Yes	Yes	Yes
NIC IP Address	255.255.255.255	255.255.255.255	255.255.255.255	255.255.255.255
Subnet Mask	255.255.255.255	255.255.255.255	255.255.255.255	255.255.255.255
Gateway IP Address	255.255.255.255	255.255.255.255	255.255.255.255	255.255.255.255
DNS Server IP Address	255.255.255.255	255.255.255.255	255.255.255.255	255.255.255.255
Zones	See Zone Programming Default Values			
Reporter				
Primary CS Info				
Phone Type	Contact Id: 4 Digit	Contact Id: 4 Digit	Contact Id: 4 Digit	Contact Id: 4 Digit
Communicator Type	None	None	None	None
Phone Number	Blank	Blank	Blank	Blank
Account Number	FFFF	FFFF	FFFF	FFFF
Dynamic Priority	None	None	None	None
Dynamic Delay	None	None	None	None
Report All	Press to Report All	Press to Report All	Press to Report All	Press to Report All
Report Alarms	Enabled	Enabled	Enabled	Enabled
Report Troubles	Enabled	Enabled	Enabled	Enabled
Report Open/Close	Disabled	Disabled	Disabled	Disabled
Report Tests	Enabled	Enabled	Enabled	Enabled

LYNX Touch (L5210CN/L7000CN) Canada Programming Default Values

Program Function	Configuration 1	Configuration 2	Configuration 3	Configuration 4
Secondary CS Info				
Phone Type	None	None	None	None
Communicator Type	None	None	None	None
Phone Number	Blank	Blank	Blank	Blank
Account Number	FFFF	FFFF	FFFF	FFFF
Dynamic Priority	None	None	None	None
Dynamic Delay	None	None	None	None
Report All	Press to Report All	Press to Report All	Press to Report All	Press to Report All
Report Alarms	Enabled	Enabled	Enabled	Enabled
Report Troubles	Enabled	Enabled	Enabled	Enabled
Report Open/Close	Disabled	Disabled	Disabled	Disabled
Report Tests	Enabled	Enabled	Enabled	Enabled
Follow Me Phone 1 (L5210CN only)				
Phone Type (L5210CN only)	None	None	None	None
Phone Number (L5210CN only)	Blank	Blank	Blank	Blank
Report All (L5210CN only)	Press To Report All	Press To Report All	Press To Report All	Press To Report All
Report Alarms (L5210CN only)	Disabled	Disabled	Disabled	Disabled
Report Troubles (L5210CN only)	Disabled	Disabled	Disabled	Disabled
Report Open/Close (L5210CN only)	Disabled	Disabled	Disabled	Disabled
Report Tests (L5210CN only)	Disabled	Disabled	Disabled	Disabled
Follow Me Phone 2 (L5210CN only)				
Phone Type (L5210CN only)	None	None	None	None
Phone Number (L5210CN only)	Blank	Blank	Blank	Blank
Report All (L5210CN only)	Press To Report All	Press To Report All	Press To Report All	Press To Report All
Report Alarms (L5210CN only)	Disabled	Disabled	Disabled	Disabled
Report Troubles (L5210CN only)	Disabled	Disabled	Disabled	Disabled
Report Open/Close (L5210CN only)	Disabled	Disabled	Disabled	Disabled
Report Tests (L5210CN only)	Disabled	Disabled	Disabled	Disabled
Report Selection				
Arm Away	Enabled	Enabled	Enabled	Enabled
Arm Stay	Enabled	Enabled	Enabled	Enabled
Disarm	Enabled	Enabled	Enabled	Enabled
Exit Error	Enabled	Disabled	Enabled	Enabled
Recent Closing	Enabled	Enabled	Enabled	Enabled
Event Log Full	Enabled	Enabled	Enabled	Enabled
Trouble	Enabled	Enabled	Enabled	Enabled
Trouble Restore	Enabled	Enabled	Enabled	Enabled
Alarm Restore	Enabled	Enabled	Enabled	Enabled
Alarm Cancel	Enabled	Enabled	Enabled	Enabled
Test	Enabled	Enabled	Enabled	Enabled
Test Restore	Enabled	Enabled	Disabled	Enabled
Bypass	Enabled	Enabled	Enabled	Enabled
Bypass Restore	Enabled	Enabled	Enabled	Enabled
AC Loss	Enabled	Enabled	Enabled	Enabled
AC Loss Restore	Enabled	Enabled	Enabled	Enabled
Low Battery	Enabled	Enabled	Enabled	Enabled
Low Battery Restore	Enabled	Enabled	Enabled	Enabled
RF Low Battery	Enabled	Enabled	Enabled	Enabled
RF Low Battery Restore	Enabled	Enabled	Enabled	Enabled
Options				
PBX (L5210CN only)	Blank	Blank	Blank	Blank
Call Wait Cancel (L5210CN only)	Blank	Blank	Blank	Blank
Number of Reports	Unlimited	Unlimited	Unlimited	Unlimited
Alarm Report Delay	No Delay	15 Seconds	No Delay	No Delay
First Report Offset	6 Hrs	12 Hrs	12 Hrs	12 Hrs
Report Frequency	Never	30 Days	Never	Never

LYNX Touch (L5210CN/L7000CN) Canada Programming Default Values

Program Function	Configuration 1	Configuration 2	Configuration 3	Configuration 4
Downloader				
Phone Answer (L5210CN only)	Yes	Yes	Yes	Yes
Ans. Machine Defeat (L5210CN only)	Yes	Yes	Yes	Yes
Modem Speed (Future Use)	Slow	Slow	Slow	Slow
Ring Counter	2	2	2	2
Callback Number	Blank	Blank	Blank	Blank
Flexible Callback Number	No	No	No	No
Sounder				
Burglary Alarm Sound	Yes	Yes	Yes	Yes
Burglary Bell Timeout	4 Minutes	4 Minutes	4 Minutes	4 Minutes
Fire Bell Timeout	4 Minutes	4 Minutes	4 Minutes	4 Minutes
Arm Confirm	RF Keyfob	RF Keyfob	RF Keyfob	RF Keyfob
Alarm Options	Unlimited	2	2	2
System Settings				
Entry Delay 1	30 Seconds	45 Seconds	30 Seconds	30 Seconds
Entry Delay 2	60 Seconds	60 Seconds	60 Seconds	60 Seconds
Exit Delay	60 Seconds	60 Seconds	60 Seconds	60 Seconds
Backlight Timeout	No	No	No	No
Quick Arm	Yes	Yes	Yes	Yes
Quick Exit	Yes	Yes	Yes	Yes
Restart Exit Time	No	Yes	Yes	Yes
Force Bypass	No	No	No	No
Exit Warning	No	Yes	Yes	Yes
Auto Stay Arming	No	Yes	Yes	Yes
Lack Of Usage Notify	Disabled	Disabled	Disabled	Disabled
Power-Up In Previous	Yes	Yes	Yes	Yes
Display Alarm Cancel	No	Yes	Yes	Yes
Display Exit Time	Yes	Yes	Yes	Yes
Cross Zone Delay	3 Minutes	None	None	None
Cross Zone 1	Disabled	Disabled	Disabled	Disabled
Cross Zone 2	Disabled	Disabled	Disabled	Disabled
Z-Wave				
Z-Wave	Enabled-Installed	Enabled-Installed	Enabled-Installed	Enabled-Installed
Temperature	Fahrenheit	Fahrenheit	Fahrenheit	Fahrenheit

Zone Programming Default Values

Zone Programming Notes

1. Zone 1 is a hardwire zone; Zones 95, 96 and 99 are keypad panics.
2. For the LYNX Touch L5210/L5210CN Zones 2 to 64 are RF zones (Zones 46 to 48 are reserved for Garage Door Zones); Zones 140-155 are RF Button Zones and 180-185 are Temperature Zones.
3. For the LYNX Touch L7000/L7000CN Zones 2 to 80 are RF zones (Zones 45 to 48 are reserved for Garage Door Zones); Zones 140-163 are RF Button Zones and 180-187 are Temperature Zones.
4. The default values shown below are for the LYNX Touch L5210/L5210CN.

Zone Assignment/Alarm Response Types for Configuration 1

Zone Number	Loop Number	Device Type	Response Type	Alarm Report	Chime	Supervision	Arm Night	Zone Descriptor
1	---	New	Not Used	Yes	Disabled	End of Line	n/a	n/a
2	2	Door	Entry Exit 1	Yes	Standard	Supervised	n/a	Front
3	2	Door	Entry Exit 1	Yes	Standard	Supervised	n/a	Back
4	2	Window	Perimeter	Yes	Standard	Supervised	n/a	n/a
5	1	Motion Sensor	Interior With Delay	Yes	Disabled	Supervised	No	n/a
46	1	New	Not Used	No	Standard	Supervised	n/a	Main
47	1	New	Not Used	No	Standard	Supervised	n/a	Main
48	1	New	Not Used	No	Standard	Supervised	n/a	Main
140	3	4 Button	Arm Away	Yes	Disabled	Button	n/a	n/a
141	2	4 Button	Disarm	Yes	Disabled	Button	n/a	n/a
142	4	4 Button	Arm Stay	Yes	Disabled	Button	n/a	n/a
143	1	4 Button	No Response	No	Disabled	Button	n/a	n/a
144	3	4 Button	Arm Away	Yes	Disabled	Button	n/a	n/a
145	2	4 Button	Disarm	Yes	Disabled	Button	n/a	n/a
146	4	4 Button	Arm Stay	Yes	Disabled	Button	n/a	n/a
147	1	4 Button	No Response	No	Disabled	Button	n/a	n/a
180	---	Temperature	Monitor	Yes	Disabled	High Temp	n/a	n/a
181	---	Temperature	Monitor	Yes	Disabled	Low Temp	n/a	n/a
182	---	Temperature	Monitor	Yes	Disabled	High Temp	n/a	n/a
183	---	Temperature	Monitor	Yes	Disabled	Low Temp	n/a	n/a
184	---	Temperature	Monitor	Yes	Disabled	High Temp	n/a	n/a
185	---	Temperature	Monitor	Yes	Disabled	Low Temp	n/a	n/a
95	---	Fire	Fire No Verification	Yes	Disabled	Panic Trigger	n/a	n/a
96	---	Medical	Not Used	Yes	Disabled	Panic Trigger	n/a	n/a
99	---	Police	24-Hour Silent	Yes	Disabled	Panic Trigger	n/a	n/a

Zone Assignment/Alarm Response Types for Configuration 2

Zone Number	Loop Number	Device Type	Response Type	Alarm Report	Chime	Supervision	Arm Night	Zone Descriptor
1	---	New	Not Used	Yes	Disabled	End of Line	n/a	n/a
2	2	Door	Entry Exit 1	Yes	Standard	Supervised	n/a	Front
3	2	Door	Entry Exit 1	Yes	Standard	Supervised	n/a	Back
4	2	Door	Entry Exit 1	Yes	Standard	Supervised	n/a	Garage
5	1	Motion Sensor	Interior With Delay	Yes	Disabled	Supervised	No	n/a
6	1	Smoke Detector	Fire No Verification	Yes	Disabled	Supervised	n/a	n/a
46	1	New	Not Used	No	Standard	Supervised	n/a	Main
47	1	New	Not Used	No	Standard	Supervised	n/a	Main
48	1	New	Not Used	No	Standard	Supervised	n/a	Main
140	3	4 Button	Arm Away	Yes	Disabled	Button	n/a	n/a
141	2	4 Button	Disarm	Yes	Disabled	Button	n/a	n/a
142	4	4 Button	Arm Stay	Yes	Disabled	Button	n/a	n/a
143	1	4 Button	No Response	No	Disabled	Button	n/a	n/a
144	3	4 Button	Arm Away	Yes	Disabled	Button	n/a	n/a
145	2	4 Button	Disarm	Yes	Disabled	Button	n/a	n/a
146	4	4 Button	Arm Stay	Yes	Disabled	Button	n/a	n/a
147	1	4 Button	No Response	No	Disabled	Button	n/a	n/a
180	---	Temperature	Monitor	Yes	Disabled	High Temp	n/a	n/a
181	---	Temperature	Monitor	Yes	Disabled	Low Temp	n/a	n/a
182	---	Temperature	Monitor	Yes	Disabled	High Temp	n/a	n/a
183	---	Temperature	Monitor	Yes	Disabled	Low Temp	n/a	n/a
184	---	Temperature	Monitor	Yes	Disabled	High Temp	n/a	n/a
185	---	Temperature	Monitor	Yes	Disabled	Low Temp	n/a	n/a
95	---	Fire	Fire No Verification	Yes	Disabled	Panic Trigger	n/a	n/a
96	---	Medical	24-Hour Auxiliary	Yes	Disabled	Panic Trigger	n/a	n/a
99	---	Police	24-Hour Audible	Yes	Disabled	Panic Trigger	n/a	n/a

Regulatory Agency Statements

Federal Communications Commission (FCC) Part 15

The user shall not make any changes or modifications to the equipment unless authorized by the Installation Instructions or User's Manual. Unauthorized changes or modifications could void the user's authority to operate the equipment.

CLASS B DIGITAL DEVICE STATEMENT

NOTE: This equipment has been tested and found to comply with the limits for a Class B digital device, pursuant to part 15 of the FCC Rules. These limits are designed to provide reasonable protection against harmful interference in a residential installation. This equipment generates, uses and can radiate radio frequency energy and, if not installed and used in accordance with the instructions, may cause harmful interference to radio communications. However, there is no guarantee that interference will not occur in a particular installation. If this equipment does cause harmful interference to radio or television reception, which can be determined by turning the equipment off and on, the user is encouraged to try to correct the interference by one or more of the following measures:

- Reorient or relocate the receiving antenna.
- Increase the separation between the equipment and receiver.
- Connect the equipment into an outlet on a circuit different from that to which the receiver is connected.
- Consult the dealer or an experienced radio/TV technician for help.

This Class B digital apparatus complies with Canadian ICES-003.

Cet appareil numérique de la classe B est conforme à la norme NMB-003 du Canada.

FCC IC Statement

This device complies with Part 15 of FCC Rules and RSS-210 of Industry Canada. Operation is subject to the following two conditions: (1) This device may not cause harmful interference, and (2) This device must accept any interference received, including interference that may cause undesired operation.

Cet appareil est conforme à la partie 15 des règles de la FCC & de RSS-210 des Industries Canada. Son fonctionnement est soumis aux conditions suivantes: (1) Cet appareil ne doit pas causer d'interférences nuisibles. (2) Cet appareil doit accepter toute interférence reçue y compris les interférences causant une réception indésirable.

TELEPHONE/MODEM INTERFACE

Federal Communications Commission (FCC) Part 68

This equipment complies with Part 68 of the FCC rules. On the front cover of this equipment is a label that contains the FCC registration number and Ringer Equivalence Number (REN). You must provide this information to the telephone company when requested.

This equipment uses the following USOC jack: RJ31X

This equipment may not be used on telephone-company-provided coin service. Connection to party lines is subject to state tariffs. This equipment is hearing-aid compatible.

Industry Canada

NOTICE: The Industry Canada Label identifies certified equipment. This certification means that the equipment meets telecommunications network protective, operational and safety requirements as prescribed in the appropriate Terminal Equipment Technical Requirements document(s). The Department does not guarantee the equipment will operate to the user's satisfaction.

Before installing this equipment, users should ensure that it is permissible to be connected to the facilities of the local telecommunications company. The equipment must also be installed using an acceptable method of connection. The customer should be aware that compliance with the above conditions may not prevent degradation of service in some situations.

Repairs to certified equipment should be coordinated by a representative designated by the supplier. Any repairs or alterations made by the user to this equipment, or equipment malfunctions, may give the telecommunications company to request the user to disconnect the equipment.

Users should ensure for their own protection that the electrical ground connections of the power utility, telephone lines and internal metallic water pipe system, if present, are connected together. This precaution may be particularly important in rural areas.

Caution: Users should not attempt to make such connections themselves but should contact appropriate electric inspection authority, or electrician, as appropriate.

AVIS: L'étiquette d'Industrie Canada identifie le matériel homologué. Cette étiquette certifie que le matériel est conforme aux normes de protection, d'exploitation et de sécurité des réseaux de télécommunications, comme le prescrivent les documents concernant les exigences techniques relatives au matériel terminal. Le Ministère n'assure toutefois pas que le matériel fonctionnera à la satisfaction de l'utilisateur.

Avant d'installer ce matériel, l'utilisateur doit s'assurer qu'il est permis de le raccorder aux installations de l'entreprise locale de télécommunication. Le matériel doit également être installé en suivant une méthode acceptée de raccordement. L'abonné ne doit pas oublier qu'il est possible que la conformité aux conditions énoncées ci-dessus n'empêche pas la dégradation du service dans certaines situations.

Les réparations de matériel homologué doivent être coordonnées par un représentant désigné par le fournisseur. L'entreprise de télécommunications peut demander à l'utilisateur de débrancher un appareil à la suite de réparations ou de modifications effectuées par l'utilisateur ou à cause de mauvais fonctionnement.

Pour sa propre protection, l'utilisateur doit s'assurer que tous les fils de mise à la terre de la source d'énergie électrique, de lignes téléphoniques et des canalisations d'eau métalliques, s'il y en a, sont raccordés ensemble. Cette précaution est particulièrement importante dans les régions rurales.

Avertissement : L'utilisateur ne doit pas tenter de faire ces raccordements lui-même; il doit avoir recours à un service d'inspection des installations électriques, ou à un électricien, selon le cas.

Ringer Equivalence Number Notice:

The **Ringer Equivalence Number (REN)** assigned to each terminal device provides an indication of the maximum number of terminals allowed to be connected to a telephone interface. The termination on an interface may consist of any combination of devices subject only to the requirement that the sum of the Ringer Equivalence Numbers of all the devices does not exceed 5.

AVIS : L'indice d'équivalence de la sonnerie (IES) assigné à chaque dispositif terminal indique le nombre maximal de terminaux qui peuvent être raccordés à une interface. La terminaison d'une interface téléphonique peut consister en une combinaison de quelques dispositifs, à la seule condition que la somme d'indices d'équivalence de la sonnerie de tous les dispositifs n'excède pas 5.

RF Exposure



WARNING: The LYNX Touch must be installed to provide a separation distance of at least 7.8 in (20 cm) from all persons and not co-located or operated in conjunction with any other transmitter except in accordance with FCC multi-transmitter product procedures.

WARNING
THE LIMITATIONS OF THIS ALARM SYSTEM

While this System is an advanced design security system, it does not offer guaranteed protection against burglary, fire or other emergency. Any alarm system, whether commercial or residential, is subject to compromise or failure to warn for a variety of reasons. For example:

- Intruders may gain access through unprotected openings or have the technical sophistication to bypass an alarm sensor or disconnect an alarm warning device.
- Intrusion detectors (e.g., passive infrared detectors), smoke detectors, and many other sensing devices will not work without power. Battery-operated devices will not work without batteries, with dead batteries, or if the batteries are not put in properly. Devices powered solely by AC will not work if their AC power supply is cut off for any reason, however briefly.
- Signals sent by wireless transmitters may be blocked or reflected by metal before they reach the alarm receiver. Even if the signal path has been recently checked during a weekly test, blockage can occur if a metal object is moved into the path.
- A user may not be able to reach a panic or emergency button quickly enough.
- While smoke detectors have played a key role in reducing residential fire deaths in the United States, they may not activate or provide early warning for a variety of reasons in as many as 35% of all fires, according to data published by the Federal Emergency Management Agency. Some of the reasons smoke detectors used in conjunction with this System may not work are as follows. Smoke detectors may have been improperly installed and positioned. Smoke detectors may not sense fires that start where smoke cannot reach the detectors, such as in chimneys, in walls, or roofs, or on the other side of closed doors. Smoke detectors also may not sense a fire on another level of a residence or building. A second floor detector, for example, may not sense a first floor or basement fire. Finally, smoke detectors have sensing limitations. No smoke detector can sense every kind of fire every time. In general, detectors may not always warn about fires caused by carelessness and safety hazards like smoking in bed, violent explosions, escaping gas, improper storage of flammable materials, overloaded electrical circuits, children playing with matches, or arson. Depending on the nature of the fire and/or location of the smoke detectors, the detector, even if it operates as anticipated, may not provide sufficient warning to allow all occupants to escape in time to prevent injury or death.
- Passive Infrared Motion Detectors can only detect intrusion within the designed ranges as diagrammed in their installation manual. Passive Infrared Detectors do not provide volumetric area protection. They do create multiple beams of protection, and intrusion can only be detected in unobstructed areas covered by those beams. They cannot detect motion or intrusion that takes place behind walls, ceilings, floors, closed doors, glass partitions, glass doors, or windows. Mechanical tampering, masking, painting or spraying of any material on the mirrors, windows or any part of the optical system can reduce their detection ability. Passive Infrared Detectors sense changes in temperature; however, as the ambient temperature of the protected area approaches the temperature range of 90° to 105°F (32° to 40°C), the detection performance can decrease.
- Alarm warning devices such as sirens, bells or horns may not alert people or wake up sleepers if they are located on the other side of closed or partly open doors. If warning devices are located on a different level of the residence from the bedrooms, then they are less likely to waken or alert people inside the bedrooms. Even persons who are awake may not hear the warning if the alarm is muffled by noise from a stereo, radio, air conditioner or other appliance, or by passing traffic. Finally, alarm warning devices, however loud, may not warn hearing-impaired people.
- Telephone lines needed to transmit alarm signals from a premises to a central monitoring station may be out of service or temporarily out of service. Telephone lines are also subject to compromise by sophisticated intruders.
- Even if the system responds to the emergency as intended, however, occupants may have insufficient time to protect themselves from the emergency situation. In the case of a monitored alarm system, authorities may not respond appropriately.
- This equipment, like other electrical devices, is subject to component failure. Even though this equipment is designed to last as long as 10 years, the electronic components could fail at any time.

The most common cause of an alarm system not functioning when an intrusion or fire occurs is inadequate maintenance. This alarm system should be tested weekly to make sure all sensors and transmitters are working properly. The security keypad (and remote keypad) should be tested as well.

Wireless transmitters (used in some systems) are designed to provide long battery life under normal operating conditions. Longevity of batteries may be as much as 4 to 7 years, depending on the environment, usage, and the specific wireless device being used. External factors such as humidity, high or low temperatures, as well as large swings in temperature, may all reduce the actual battery life in a given installation. This wireless system, however, can identify a true low battery situation, thus allowing time to arrange a change of battery to maintain protection for that given point within the system.

Installing an alarm system may make the owner eligible for a lower insurance rate, but an alarm system is not a substitute for insurance. Homeowners, property owners and renters should continue to act prudently in protecting themselves and continue to insure their lives and property.

We continue to develop new and improved protection devices. Users of alarm systems owe it to themselves and their loved ones to learn about these developments.

UL Notices

1. For UL Residential Burglar Alarm installations with line security, total exit delay time must not exceed 60 seconds. For UL Burglar Alarm installations without line security, total exit delay time must not exceed 120 seconds.
2. Periodic testing must be at least every 24 hours.
3. Remote downloading without an alarm company technician on-site (unattended downloading) is not permissible for UL installations.
4. Auto-disarming is not a UL Listed feature.
5. As SIA limits for delay of alarm reporting and sounding can exceed UL limits for commercial and residential applications, the following UL requirements per UL681 are provided:
The maximum time that a control unit shall be programmed to delay the transmission of a signal to a remote monitoring location, or to delay the energizing of a local alarm sounding device to permit the alarm system user to enter and disarm the system, or to arm the system and exit shall not exceed:
 - a) 60 seconds for a system with standard line security or encrypted line security,
 - b) 120 seconds for a system without standard line security or encrypted line security, or
 - c) 120 seconds for a system that does not transmit an alarm signal to a remote monitoring location.

SIA Quick Reference Guide

Programming Section	Feature	Range	Shipping Default	SIA Requirement
Installation and Setup Guide or Programming Guide				
Reporter/ Report Selection	Exit Error	Enabled or Disabled	Enabled	Enabled
	Recent Closing	Enabled or Disabled	Enabled	Enabled
	Alarm Cancel	Enabled or Disabled	Enabled	Enabled
Reporter/Options	Call Wait Cancel	Enabled or Disabled	Field is blank (a PBX prefix is entered to enable)	Enabled if User has call waiting
	Number of Reports	1 to 6 Reports	2 Reports	2 Reports
	Alarm Report Delay (Abort Window)	15, 30 and 45 seconds	30 Seconds	30 Seconds*
System Settings	Entry Delay # 1	None, 15, 30, 45, 60 and 90 seconds and 2, 3 or 4	30 Seconds	30 Seconds minimum
	Entry Delay # 2	None, 15, 30, 45, 60 and 90 seconds and 2, 3 or 4	30 Seconds	30 Seconds minimum
	Exit Delay	45, 60, 90 seconds and 2 minutes	60 Seconds	45 seconds minimum
	Restart Exit Time	Enabled or Disabled	Yes (Enabled)	Enabled
	Exit Warning	Not selectable	Always enabled	Enabled
	Auto Stay Arming	Enabled or Disabled	Yes (Enabled)	Enabled
	Cross Zone Delay	30 seconds and 2 minutes (in 30 second increments), 3 minutes and 4 minutes	None (Disabled)	Enabled and two zones programmed
Zones	Fire Alarms	Zone Type "Fire with Verification" must be selected for Fire Zone 95	Disabled	Disabled
User Guide				
User Functions/ User Access	Duress	Duress Code is Programmed by Master User as User 16	Disabled	Disabled
System Functions/ Testing the System**	System Test	System tests provided as a User Function	n/a	n/a
	Communications	While the system is in Test mode, no alarm reports are sent to the Central Station	Disabled	Disabled

* Combined Entry Delay and Alarm Report Delay (Abort Window) should not exceed 1 minute.

** Refer to the User Guide for procedures on Testing the System.

Note: Using the Call Waiting Cancel feature on a non-Call Waiting line will prevent successful communication to the Central Station.

Specifications

LYNX Touch Series Security Controls

Physical:

Dimensions: 8.5" W x 6" H x 1.875" D

Electrical:

Voltage Input: 9 Vdc from plug-in 2.7A power supply

Rechargeable Backup Battery: Nickel-metal hydride battery pack rated at 7.2 Vdc

Communication:

Formats Supported: ADEMCO Contact ID® Reporting, 10 characters/sec., DTMF (TouchTone)
Data Tones, 1400/2300Hz Handshake, 1400Hz Kissoff.

Line Seize: SIA/DCS Format, 2225Hz Handshake, Data Tones, 2025/2235Hz, baud
Double Pole

Ringer Equivalence: 0.5B

ACTA Registration No.: US: AC3AL05BL5000

Hardwire Zone:

2K ohms, End of Line Resistor (EOLR), 200 ohms max wire resistance, dry contacts only

Trigger Output:

1K ohms to ground when closed (output low) 3ma

Contacting Technical Support

PLEASE, before you call Technical Support, be sure you:

- READ THE INSTRUCTIONS!
- Check all wiring connections.
- Determine that the power supply and/or backup battery are supplying proper voltages.
- Verify your programming information where applicable.
- Note the proper model number of this product, and the version level (if known) along with any documentation that came with the product.
- Note your Honeywell customer number and/or company name.

Having this information handy will make it easier for us to serve you quickly and effectively.

<i>Technical Support:</i> 1-800-645-7492 (8 a.m.-10 p.m. E.S.T.)
<i>MyWebTech:</i> http://www.honeywell.com/security/hsc/resources/MyWebTech

Glossary

AES – Advanced Encryption Standard

APL – Advanced Protection Logic

dBm – decibels milliwatt (power ratio)

DHCP – Dynamic Host Configuration Protocol, which provides a mechanism for allocating IP addresses dynamically so that addresses can be reused when hosts no longer need them.

DNS – Domain Name System, which is a distributed hierarchical naming system used to resolve domain names (e.g., www.yahoo.com) into numerical IP addresses (e.g., 204.17.25.1).

Gateway IP Address – A gateway (sometimes called a router) is a computer and/or software used to connect two or more networks (including incompatible networks) and translates information from one network to the other. The Gateway IP address is the IP address for the gateway.

GPRS – General Packet Radio Service

GSM – Global System for Mobile communications, which is an international standard for digital mobile phone systems used for cellular communication.

IMEI – International Mobile Equipment Identity number

IP – Internet Protocol

IP Address – A unique number consisting of four parts separated by periods, sometimes called a "dotted quad.," for example: 204.17.29.11, assigned to every computer/workstation connected to the Internet. IP numbers can be "static" (assigned and unchanging) or "dynamic," assigned via DHCP at each and every startup.

ISP – Internet Service Provider

KBPS – Kilobits per second

MAC ID – Media Access Code; located on the module label.

NIC – Network Interface Card

RSSI – Received Signal Strength Indication

SCID – SIM Card ID

Subnet Mask – A Subnet is a portion of a network that shares a network address with other portions of the network, and is distinguished by a subnet number. The Subnet Mask is a 32-bit address mask used in IP to indicate the bits of an IP address that are being used for the subnet address.

WEP – Wired Equivalent Privacy

WPA – WiFi Protected Access

WPS – WiFi Protected Setup

– Index –

24-hour silent..... 60
 300-03866..... 5
 300-04063/300-04063V1 10
 300-04064/300-04064V1 10
 300-04065/300-04065V1 10
 300-04705/300-04705V1 10
 5800 Series transmitter loop numbers 19
 5800 Series transmitters 17
 5802MN..... 17
 5804BD..... 17
 5804BDV 17
 5804E 17
 5805-6..... 17
 5806 19
 5816 17
 5817 17

A

AC Power 10, 11
 AC Power loss 10
 ADEMCO Contact ID 82
 Armed system test 68
 Audio alarm verification (two-way voice feature) 65
 Auto stay arming 48

B

Babysitter code 61
 Backup battery 10, 11, 82
 Button transmitters..... 17

C

Change installer code 27
 Communication modules 12
 Communications ID numbers 52
 Communications status..... 51
 Configuring communication & home automation
 modules 12
 Contact ID event log codes 66
 Contact ID reporting 82
 Contacting technical support 83
 Cross zone 1/cross zone 2..... 48
 Cross zone delay 48, 49, 50

D

Data encryption 58
 Desktop mounting 7
 Diagnostics..... 51, 52
 Dialer delay..... 68
 Dialer test 69
 Dip switches 17
 Display alarm cancel 48
 Display exit time..... 48
 Duress code 61

E

Enroll the WiFi module..... 55
 Enter installer programming mode 23
 Enter/change the master code..... 60
 Entry delay 25, 48
 Entry/exit burglary..... 25
 Ethernet information 51
 Exit delay 22, 25, 48, 68, 80
 Exit door..... 48
 Exit warning 48
 Exiting program mode..... 24

F

Factory defaults..... 57
 Flexible callback 58
 Follow me reminder feature..... 63
 Follow me system announcement..... 62
 Force bypass 48

G

Garage (burglary) 26
 Garage monitor..... 26
 General programming information..... 23
 Go-No-Go test 18
 GSM information..... 51

H

Home screen..... 21
 House identification 17

I

ILP5..... 30
 ILP5 ethernet communications module 12, 14
 Installer code 60
 Installer menu 23
 Installing wireless zones 18, 19
 Installing/configuring communication & home
 automation modules 13, 15

K

Key/touchscreen operation 60
 Keys..... 17

L

L5000DM 7
 L5100-WiFi module 15
 L5100-Zwave home automation module..... 15
 Lack of usage notify 48
 Liquid crystal display (LCD) touch-screen 20
 Loading factory defaults..... 24
 LYNX Touch (L5100CN) Canada programming default
 values 73
 LYNX Touch programming default tables 73
 LYNXRCHKIT-SC..... 10
 LYNXRCHKIT-SHA..... 5

M

Master code 60

Master Code 61

Memory of alarm 60

Menu screens 22

Mounting base 7

N

Navigating menus 20, 22

Navigation keys 21

News 21

O

Operator commands 65

P

Panic key/icons 60

Plug-in power supply 10

Power-up in previous 48

Program date and time 30

Program keys 38, 39

Program the communications module 31

Program the Z-wave module 34

Program zones 35

Q

Quick arm 48

Quick exit 48

R

Range 17

Reboot 69

Rebooting the system 69

Register by phone 53

Register device with pin 54

Register through AlarmNet Direct website 53

Register through LYNX Touch diagnostics 53

Registering the LYNX Touch 52

Regulatory agency statements 78

Remote phone control 63

Remote programming 58

Remote programming/control 58

Reporter 40, 41

Reset master user code 61

RF sniffer test mode 18

S

Secondary user codes 61

Security code 48

Security code handshake 58

Security codes 60

Setup communication 52

SIA event log codes 66

Silent burglary 26

Site-initiated remote programming 58

Sniffer mode 68

Sounder 47

Specifications 82

Station-initiated remote programming 58

Super high capacity battery 12

Supervised RF 17

System features 5, 6

System operation 60, 61

System settings 48, 49, 50

T

Technical support 83

Test communications 52

Test ethernet 52

Test modes 68

Testing the system 68, 69

Touchscreen display 20

Traffic 21

Transmitter battery life 17

Transmitter input type 17

Transmitter loop numbers 19

Transmitter supervision 17

Unsupervised button 17

Unsupervised RF 17

Update server 55

User menu 23

W

Wall mounting 7, 10, 12

Wireless buttons 17

Wireless keypads 17, 18

Wireless zones 17

Wiring connections 8

World wide web address 83

Z

Zone discovery 69

Zone programming default tables 76, 77

Zone response type definitions 25

SUPPORT & WARRANTY INFORMATION

For the latest documentation and online support information, please go to:
<https://mywebtech.honeywell.com>

For the latest warranty information, please go to:
www.honeywell.com/security/hsc/resources/wa.



MyWebTech



Warranty

Honeywell

2 Corporate Center Drive, Suite 100
P.O. Box 9040, Melville, NY 11747
Copyright © 2014 Honeywell International Inc.

www.honeywell.com/security



800-19974 12/14 Rev. A