

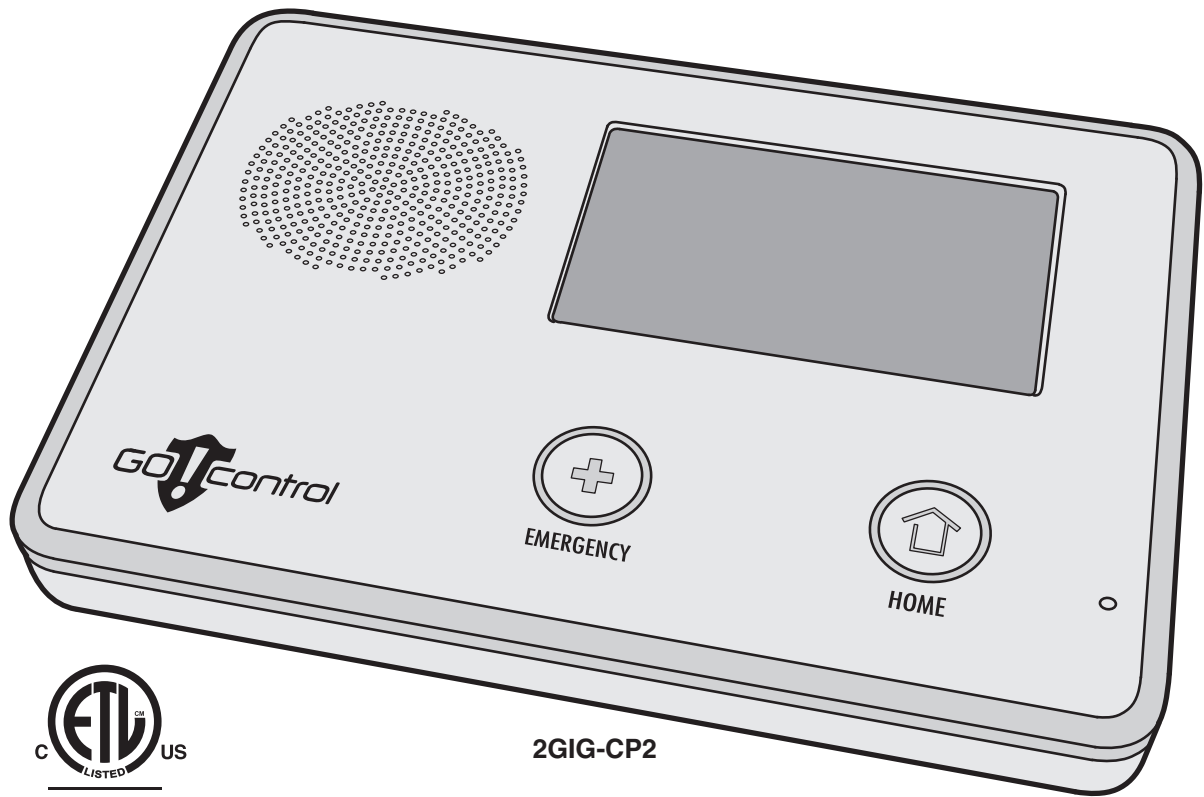

Wireless Security System



2GIG-CP2

Installation & Programming Instructions



National Fire Protection Association Standard #72 Recommendations for Smoke Detectors

STANDARD FOR ALARM LOCATION

Smoke detectors used with this system should be installed in accordance with Chapter 2 of the National Fire Alarm Code, ANSI/NFPA 72 (National Fire Protection Association, Batterymarch Park, Quincy, MA 02269) which reads as follows:

2-1.1.1 Smoke alarms shall be installed outside of each separate sleeping area in the immediate vicinity of the bedrooms and on each additional story of the family living unit including basements and excluding crawl spaces and unfinished attics. In new construction, a smoke alarm shall be installed in each sleeping room.

2-1.1.2 For family living units with one or more split levels (i.e., adjacent levels with less than one full story separation between levels), a smoke alarm required by 2-1.1.1 shall suffice for an adjacent lower level, including basements. (Exception: Where there is an intervening door between one level and the adjacent lower level, a smoke alarm shall be installed on the lower level.)

- ✓ Ceiling mounted smoke alarms should be located in the center of the room or hall, or not less than 4 inches from any wall. When the alarm is mounted on a wall, the top of the alarm should be 4 to 12 inches from the ceiling.
- ✓ Do not install smoke alarms where normal ambient temperatures are above 100°F (37.8°C), or below 40°F (4°C). Also, do not locate alarm in front of air conditioners, heating registers, or other locations where normal air circulation will keep smoke from entering the detector.

A-2.5.2.1 Smoke Detection - Are More Smoke Alarms Desirable? The required number of smoke alarms might not provide reliable early warning protection for those areas separated by a door from the areas protected by the required smoke alarms. For this reason, it is recommended that the householder consider the use of additional smoke alarms for those areas for increased protection. The additional areas include the basement, bedrooms, dining room, furnace room, utility room, and hallways not protected by the required smoke alarms. The installation of smoke alarms in kitchens, attics (finished or unfinished), or garages is not normally recommended, as these locations occasionally experience conditions that can result in improper operation.

Smoke alarms are not to be used with detector guards unless the combination has been evaluated and found suitable for the purpose.

**THIS SECURITY SYSTEM COMPLIES WITH
NFPA REQUIREMENTS FOR TEMPORAL
PULSE SOUNDING OF FIRE NOTIFICATION
APPLIANCES.**

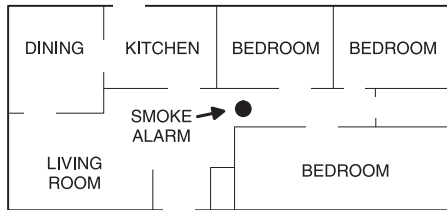

A smoke alarm should be located between the sleeping area and the rest of the family living unit.

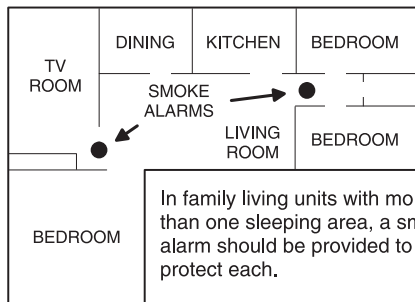
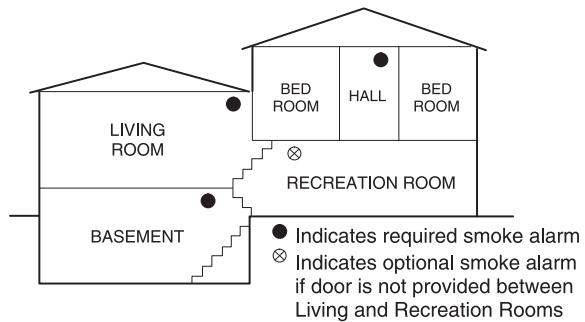

In family living units with more than one sleeping area, a smoke alarm should be provided to protect each.

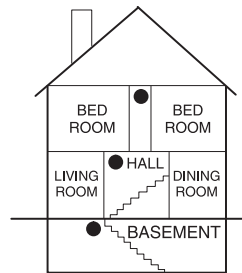

A smoke alarm should be located on each story.

Figure 1. Smoke Alarm Locations

Table of Contents

Introduction	2	Programming Outline	16
System Overview	3	SIA CP01 Defaults.....	16
Control Panel Features	4	Programming Question Table	17
Installation Outline	5	System Sensor Types	18
Wireless Installation Tips	5	Sensor Types (Zones).....	18
Wireless System Sensors	6	System Vocabulary Table	19
2GIG-DW10 Thin Door/Window Contact	6	Installer Programming	20
2GIG-DW20R Recessed Door Contact	6	RF Sensor Programming.....	20
2GIG-PIR1 Passive Infrared Motion Detector.....	6	RF Sensor Programming Outline.....	20
2GIG-KEY1 4-Button Key Ring Remote	6	RF Sensor Summary Screen.....	21
2GIG-PANIC1 Panic Button Remote.....	6	RF Sensor Programming Steps	22
2GIG-GB1 Glass Break Detector.....	6	Wired Sensor Programming	24
2GIG-SMKT2 Smoke and Heat Detector.....	6	Wired Sensor Programming Outline	24
2GIG-TS1 Wireless Touch Screen Keypad.....	6	Wired Sensor Summary Screen	24
2GIG-PAD1 Wireless Keypad	6	Wired Sensor Programming Steps.....	25
2GIG-TAKE-345 Super Switch Wireless Takeover Module ...	6	RF Key Fob Programming	26
System Accessories	7	RF Key Fob Programming Outline	26
2GIG-GSMx GSM Module.....	7	RF Key Fob Summary Screen	26
2GIG-ANT1 Internal GSM Antenna	7	RF Key Fob Programming Steps	27
2GIG-ANT1X External In-wall GSM Antenna	7	RF Keypad Programming	28
2GIG-ANT2X External Attic Mount GSM Antenna.....	7	RF Keypad Programming Outline	28
2GIG-ANT4X External In-wall GSM Antenna	7	RF Keypad Summary Screen	28
2GIG-BATT1 Standard Battery Pack	7	RF Keypad Programming Steps.....	29
2GIG-BATT1X Extended Battery Pack	7	Control Panel Programming Questions	30
2GIG-AC1 Replacement Power Supply	7	Final Installation Setup	39
Installation	8	Exiting Programming	39
Control Panel Mounting Plate	8	Customizing the Installation.....	39
Wireless Sensors.....	8	Installer Testing	40
Hardwired Loops.....	8	Testing the System	40
Remote Alarm Sounder	9	Sounder Disable/Enable	40
Solid State Output.....	9	Zone Reporting Test	40
Communicator Telephone Line	9	Walk Test Mode.....	41
Optional GSM Module Installation	10	Signal Strength Indicators.....	41
Control Panel Wiring	11	Radio Status Mode	42
Backup Battery Connection and Power Supply Wiring	11	GSM Radio Test	42
Control Panel and Power Supply Mounting	11	Telephone Test.....	42
Main Display Screens	12	Restoring Programming Defaults.....	42
Home Screen.....	12	Restore Defaults	42
Security Screen	12	Regulatory Information & Limited Warranty	43
Arming Screen.....	12	Wireless Product Notice	43
Menu Screen	12	FCC Notice	43
Status Screen	12	FCC Telephone Rules and Regulations.....	43
Toolbox Screens	13	Industry Canada Notices	43
Toolbox Screens	13	Limited Warranty.....	43
Installer Code Entry Screen.....	13	Reference Programming Question Table	44
Installer Toolbox Screen.....	13	Reference System Vocabulary Table	45
System Configuration Screen	13	Index	46
System Status Icons	14		
AC Power Icon	14		
Phone Line Failure Icon	14		
Sounder Disable Icon	14		
Backup Battery Status Icon	14		
Test Mode Icon	14		
Touch Screen Keypad Traffic Icon.....	14		
GSM Radio Icon	14		
Interior Sensor Open Icon.....	14		
Programming Navigation	15		
Navigation Arrows & Go To Button.....	15		
Questions without Sub-options	15		
Questions with Sub-options	15		
Questions with Data to Enter.....	15		
Other Buttons Displayed.....	15		

Introduction

The Go!Control Security System represents a significant advancement in fully supervised wireless security systems. The security system Control Panel incorporates many advanced and sophisticated features. The system can be expanded and customized to fit the installation's specific needs.

Designed to meet or exceed the requirements for ETL Listed residential security installations, the system also conforms to the Security Industry Association's Control Panel Standard ANSI/SIA CP-01-2007.

✓ **NOTE:** Failure to install the Control Panel and accessories in accordance with ETL requirements listed in this manual voids the ETL listing mark assigned by Intertek.

Many insurance companies offer discounts on homeowners' and renters' policies when a security system is installed. Discount credits vary with different companies and generally increase in savings with an increase in the level of protection. Inform the user to ask their insurance agent about savings available.

This security system is ETL Listed. For an ETL smoke alarm system, there must be at least one smoke detector programmed into the Control Panel to meet National Fire Protection Association (NFPA) Rule 72-Chapter 2, and UL 217 requirements. Many insurance companies require meeting these requirements to qualify for a discount. For an ETL smoke alarm system, use only approved model smoke detectors with this Control Panel.

✓ **NOTE:** Some cities and municipalities may require an alarm system permit. Check with the local authorities before installing this system.

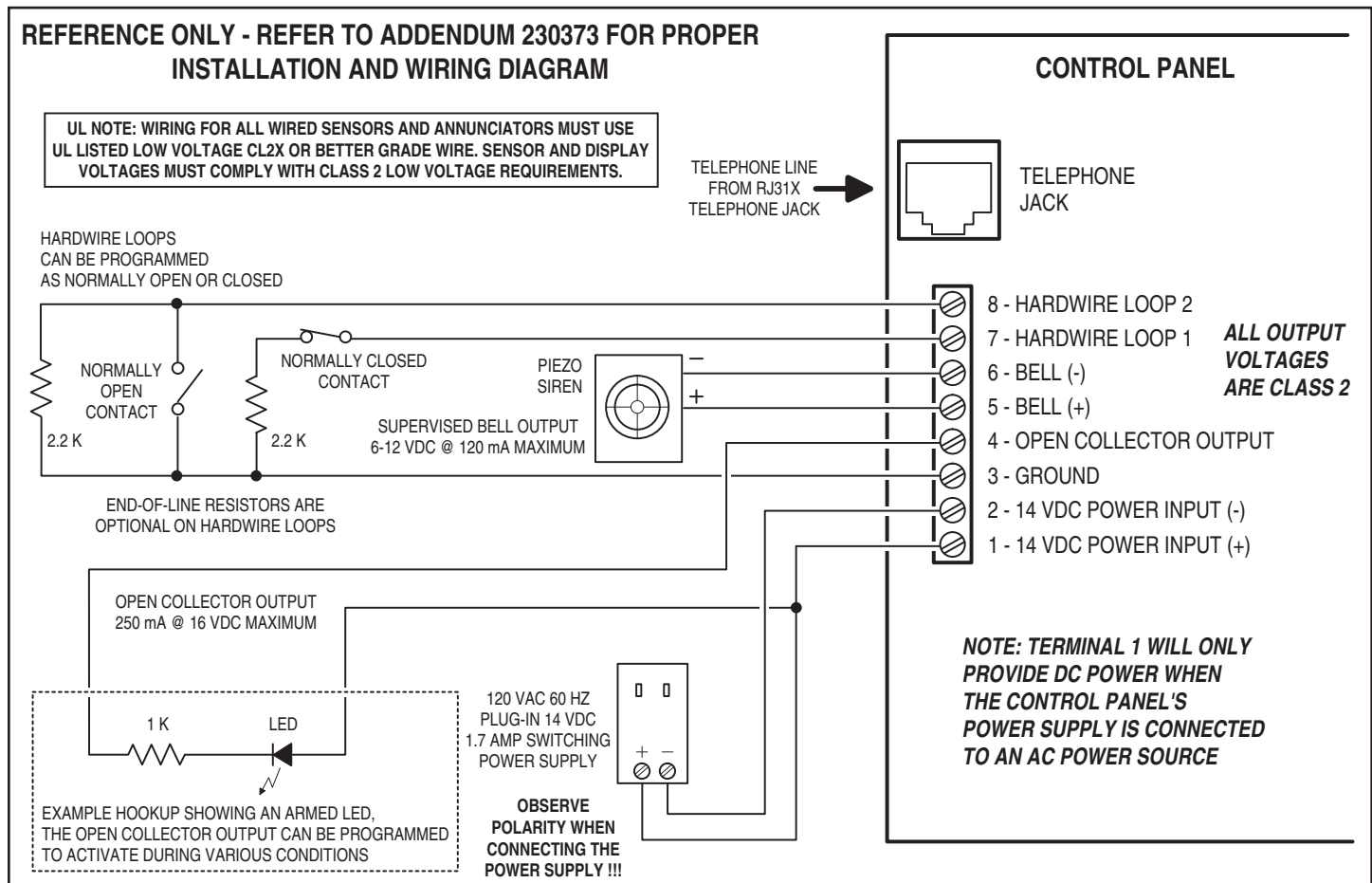
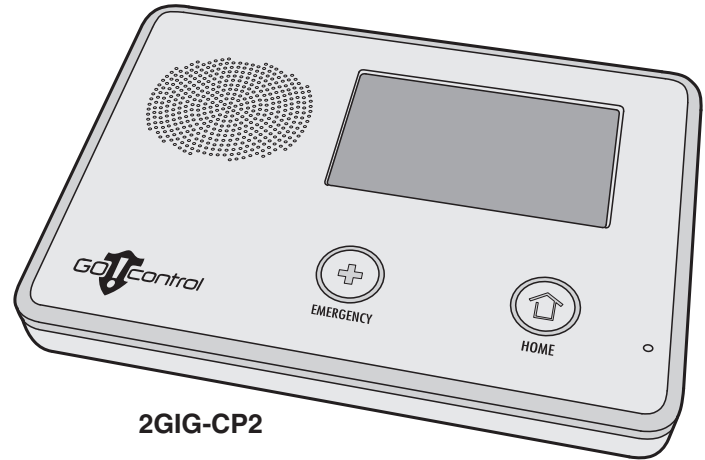

Figure 2. Control Panel Wiring Diagram

The system's Control Panel features a color touch screen display that allows control of all system functions and programming. The display clearly shows the installer and subscriber system and installation status. The helpful scrolling text, along with the voice prompts that the Control Panel sounds, make installation, programming, and operation very easy compared to keypad-programmed and operated security systems of the past.

The system supports 48 wireless sensors of various types, two hardwire loops, 15 sensor response types, a supervised bell output, and a programmable solid-state control output. An on-board digital communicator reports alarms and trouble to a central monitoring station receiver via the standard telephone network. The Control Panel also supports 2-way voice communications with the Central Station.

An internal 345 MHz narrow-band radio receiver detects signals from wireless system sensors. The high-gain receiver allows for easy placement of the wireless sensors so signals can be received in even the toughest of installation environments.





When the optional Model 2GIG-XCVR2 900 MHz transceiver is installed, it sends and receives signals with accessory wireless touch screen keypads. Touch screen keypads allow remote control of the system through the same graphic interface design as the Control Panel.

For enhanced operation, an optional Model 2GIG-GSMx global system for mobile communications module (GSM radio modem) can be installed in the field. With the optional GSM radio modem installed, the system will have wireless Central Station reporting capability. 2-way voice communication with the Central Station can also go "over-the-air" through the GSM radio modem.

The optional GSM radio modem also allows 2-way communications with the Alarm.com server. Through this server, subscribers can query and control their system using a computer browser from anywhere in the world. The Alarm.com server can also send messages, time corrections, and software updates to the Control Panel. Special messages from the server are displayed to the subscriber on the Control Panel's color touch screen.

For home control, the Control Panel's built-in Z-Wave radio module allows controlling and monitoring various home automation devices such as lighting, locks, heating, and air conditioning.

Eight user codes including a duress code are supported. User "one" is the master code that can add or delete the other seven user codes. The Installer Code has access to system programming.

The front panel  and  buttons serve as controls as well as indicators. Pressing the  button displays emergency icons on the display for Panic, Fire, and Emergency alarm activation (each has programmable options and can be enabled or disabled). Pressing the  button changes the system display to the Home Screen.

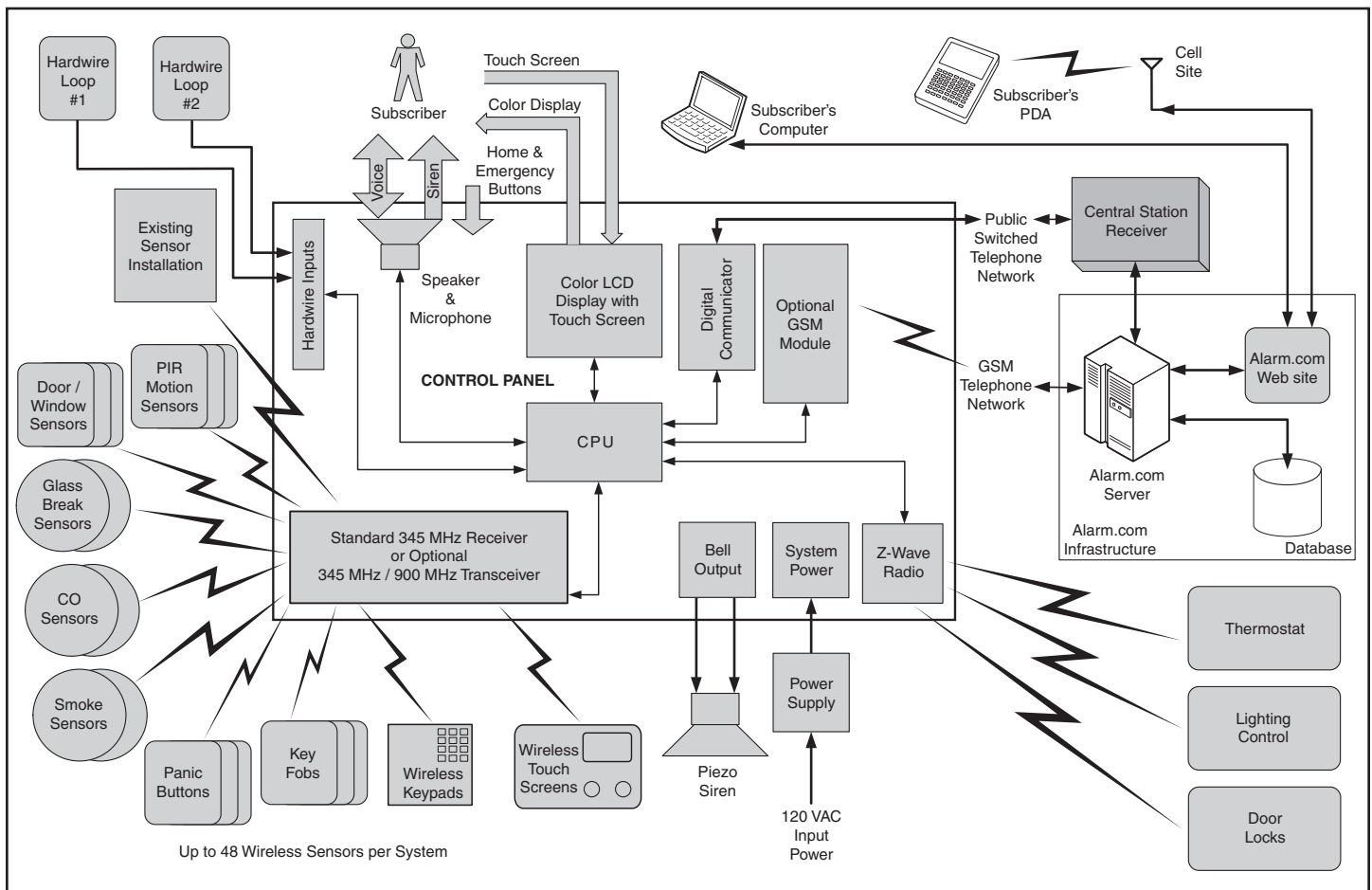

Figure 3. System Block Diagram

Control Panel Features

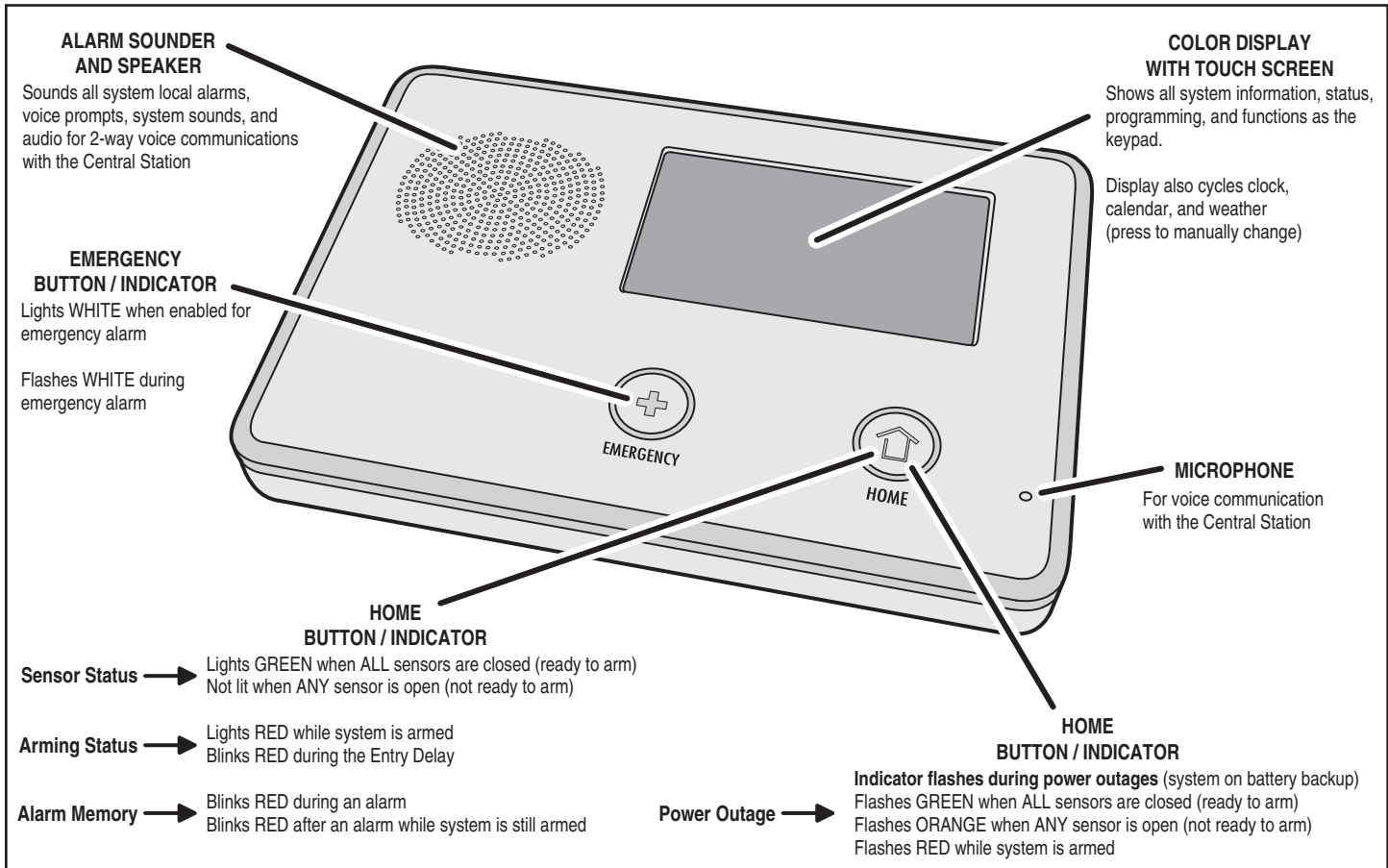

Figure 4. Control Panel External Features

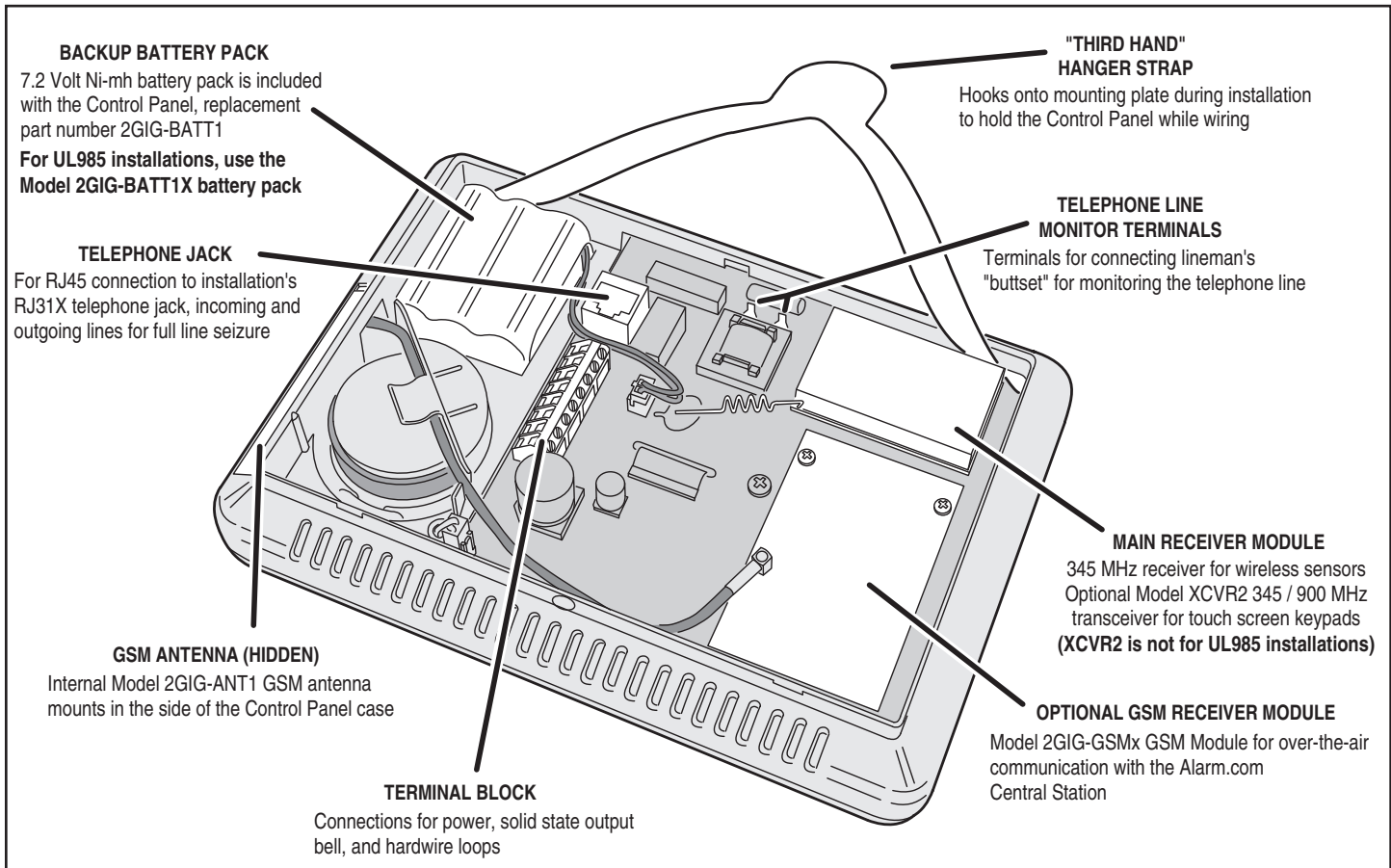

Figure 5. Control Panel Internal Features

Installation Outline

The following outline is intended to guide the installing alarm dealer through the complete installation of a Go!Control system.

Use the following outline in conjunction with this copy of the Installation Instructions to guide you through the installation.

1. Unpack the system. Identify the system components.
2. Plan the installation by creating an installation floor plan. Determine the best centralized location for the Control Panel. Decide on where the wireless sensors will be installed.
3. Identify an **un-switched** 120 VAC power source for plugging in the Control Panel's power supply.
4. Identify or install a U.S.O.C. RJ31X telephone jack for connection of the Control Panel's communicator.
5. Use the Control Panel's mounting plate as a template to mark the mounting location for the Control Panel. Mark any drywall cutouts behind the mounting plate required for the installation and make the cutouts.
6. Attach the mounting plate to the wall using three screws.
7. Install each of the system's wireless sensors. If either of the two hardwire loops are going to be used, install the contacts and route the loop wire to the Control Panel's wall cutout. Use the log in the quick programming guide to document each sensor's ID number and location.
8. Install the optional remote sounder, and route the connection wire to the Control Panel's wall cutout.
9. Route the telephone line from the RJ31X jack to the Control Panel's wall cutout.
10. Using the "third hand" strap, hang the Control Panel on the mounting plate in preparation for wiring.
11. Connect all wiring to the Control Panel's terminal block.
12. Plug the telephone line into the Control Panel's telephone jack.
13. Plug the backup battery connector into the connector on the Control Panel's circuit board.
14. Swing the Control Panel up, placing the bottom over the lip of the mounting bracket. Push the top of the Control Panel into the mounting bracket until it snaps into place, then secure it with the retaining screw.
15. Plug the power supply into the **un-switched** 120 VAC wall outlet.
16. Program the system as described in this manual and mark the check boxes in the Operation and User's Guide to indicate any custom setup to the subscriber.
17. Test the system as described in this manual.
18. Instruct the subscriber on the system operation and provide the Operation and User's Guide to the subscriber.

Wireless Installation Tips

When installing any wireless system, certain limitations must be considered. Low power wireless transmitter signals will **not** broadcast equally through all types of construction materials. The Control Panel contains a very sensitive receiver that should allow placement of transmitters in almost all locations.

Here are some general wireless guidelines that should be reviewed before beginning the installation. Follow these tips to create the best possible functioning wireless installation.

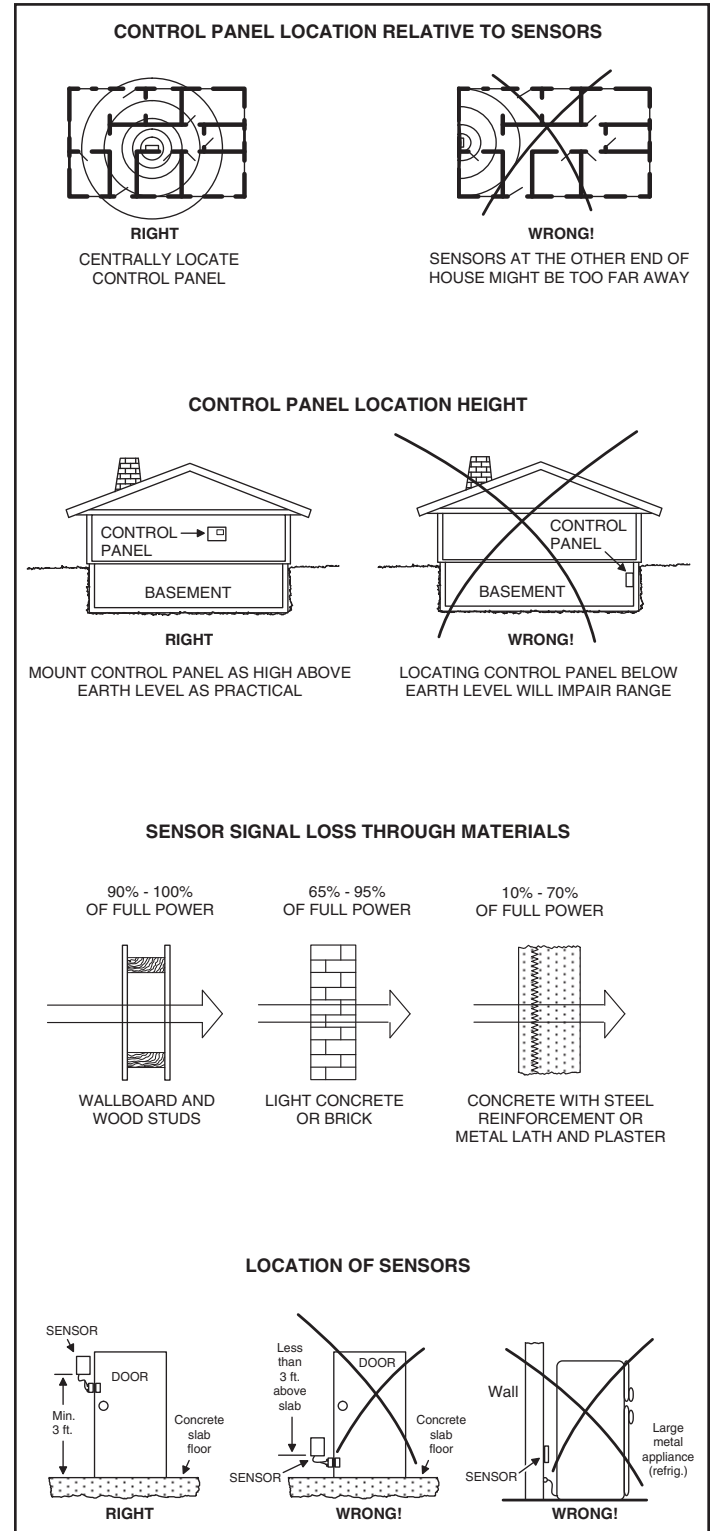

Figure 6. Wireless Installation Tips

Wireless System Sensors

2GIG-DW10

Thin Door/Window Contact

- For narrow applications, sensor is only 3/4" wide
- Fully supervised
- Rare earth magnet
- Lithium battery
- Supports internal and external contacts
- Can be used for two zones of protection
- 345 MHz
- ETL Listed

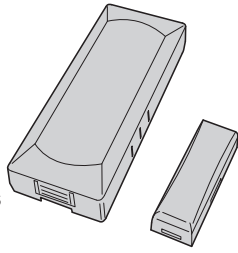

2GIG-DW20R

Recessed Door Contact

- Compact size, only 2-1/2" long
- Fully supervised
- Rare earth magnet
- Lithium battery
- 345 MHz
- ETL Listed

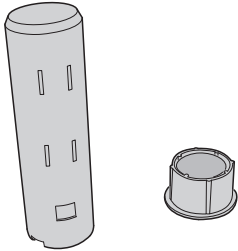

2GIG-PIR1

Passive Infrared Motion Detector

- Dual element sensor with 50' by 50' range
- 45 lb. pet immune
- 90 degree look down
- Lithium battery
- 345 MHz
- ETL Listed

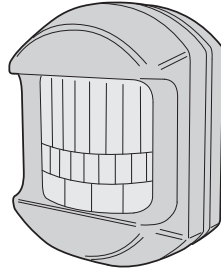

2GIG-KEY1

4-Button Key Ring Remote

- Arms system in Stay or Away Mode
- Disarms system
- Auxiliary output and emergency functions
- Lithium battery
- 345 MHz
- ETL Listed

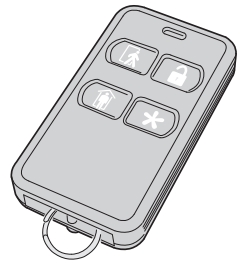

2GIG-PANIC1

Panic Button Remote

- For triggering emergency alarm
- Small and lightweight
- 5-second button lockout
- Lithium battery
- 345 MHz
- ETL Listed

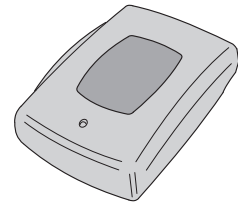

2GIG-GB1

Glass Break Detector

- Monitors for the sound of breaking glass
- Two test LEDs
- Dual shatter recognition technology (thud then crash)
- Lithium battery
- 345 MHz
- ETL Listed

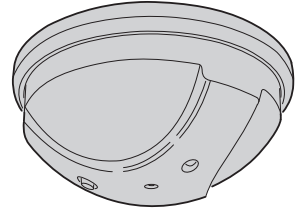

2GIG-SMKT2

Smoke and Heat Detector

- Photoelectric-type detector with rate-of-rise and fixed 135° heat sensors
- Status indicator
- Built-in 85 dBA sounder
- Lithium battery
- 345 MHz
- ETL Listed

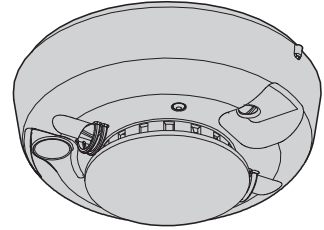

2GIG-TS1

Wireless Touch Screen Keypad

- Wireless communication with Control Panel
- Same graphic interface as Control Panel
- Supports all functions of the Control Panel
- 900 MHz
- **NOTE: Not for UL985 installations.**

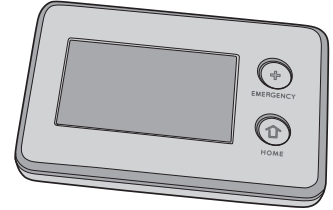

2GIG-PAD1

Wireless Keypad

- Arms system in Stay or Away Mode
- Disarms system
- Fire and Panic emergency functions
- Lithium batteries
- 345 MHz
- ETL Listed

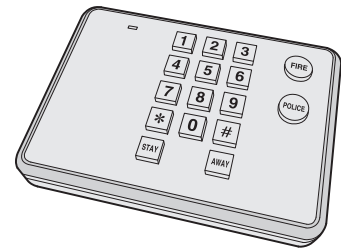

2GIG-TAKE-345

Super Switch Wireless Takeover Module

- Eight-channel transmitter
- Converts up to eight hardwired loops into eight wireless sensor zones
- 9-16 VDC, 50 mA
- Can be powered from existing Control Panel
- 345 MHz
- ETL Listed

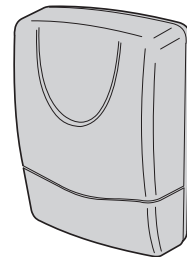

2GIG-GSMx

GSM Module

- Cellular telephone module
- Plugs into Control Panel
- Provides 2-way GSM radio communication
- Enrolls with cellular service provider

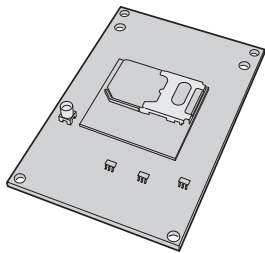

2GIG-ANT1

Internal GSM Antenna

- Antenna installs inside Control Panel
- Plugs into GSM module
- Small size
- Locking connector

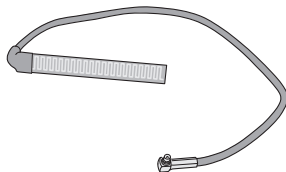

2GIG-ANT1X

External In-wall GSM Antenna

- Antenna installs in the wall behind Control Panel
- 2-foot cable
- Plugs into GSM module
- Locking connector

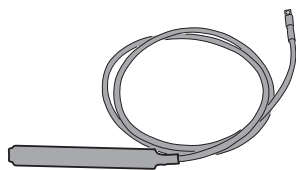

2GIG-ANT2X

External Attic Mount GSM Antenna

- Antenna installs in attic above Control Panel
- 10-foot cable
- Plugs into GSM module
- Locking connector

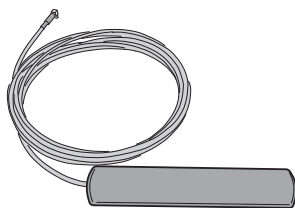

2GIG-ANT4X

External In-wall GSM Antenna

- Antenna installs in the wall behind Control Panel
- 2-foot cable
- Plugs into GSM module
- Locking connector

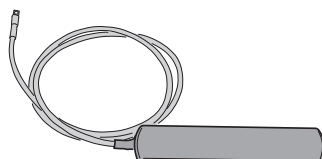

2GIG-BATT1

Standard Battery Pack

- Standard battery supplied with Control Panel
- Also available as a replacement item
- Nickel metal hydride (NiMH) battery

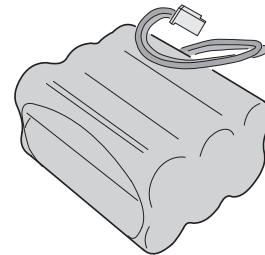

2GIG-BATT1X

Extended Battery Pack

- Optional extra capacity battery
- Replaces standard internal Control Panel battery
- Required for UL985 fire warning system listing
- Nickel metal hydride (NiMH) battery

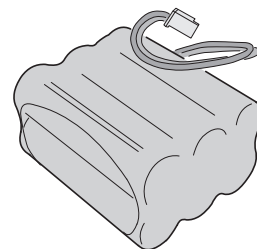

2GIG-AC1

Replacement Power Supply

- High efficiency switching power supply
- 120 VAC @ 60 Hz input
- 14 VDC @ 1700 mA output
- Screw terminals for wiring connecting to the Control Panel
- Includes retaining bracket for standard and Decora style outlets.

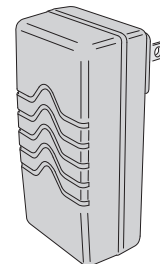

Installation

Control Panel Mounting Plate

The Control Panel should be mounted on the wall in an easy location for the subscriber to operate the system.

1. Remove the locking screw from the top of the Control Panel case and remove the mounting plate.
2. Use the mounting plate as a template to mark the wall for the wiring cutout slot. Use a drywall saw to cut the slot. If using the optional Model 2GIG-GSMx GSM module with the external Model 2GIG-ANT1X or Model 2GIG-ANT2X antenna, remove the plastic knockout labeled "EXTERNAL ANTENNA" on the mounting plate. Mark and cut a slot in the drywall for the external antenna.
3. Attach the mounting plate to the wall using three screws.

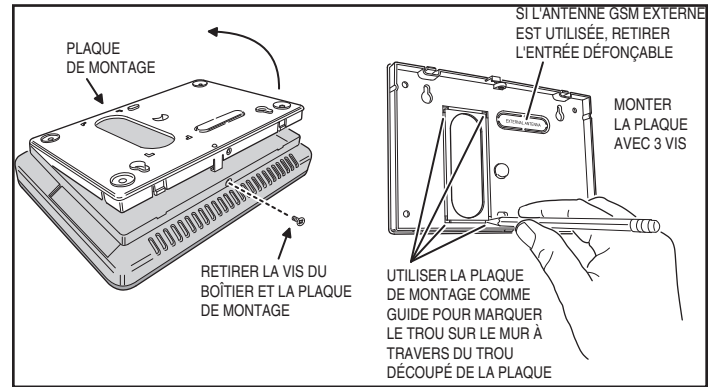

Figure 7. Wall Mounting Template

Wireless Sensors

Each wireless sensor needs to be installed at its desired location.

1. Following the instructions included with each wireless sensor, install each sensor at its desired location.
2. Use the Installation Log to document each sensor's ID number and location.

Hardwired Loops

Hardwired loops can be programmed either normally open (N/O) or normally closed (N/C). End-of-line resistors (EOLR) can also be used to supervise the loops.

Only contacts should be used with the hardwired loops. The Control Panel does not support powering external devices (PIR's, etc.).

✓ **NOTE: HARDWIRED LOOPS CANNOT BE USED FOR A CO OR FIRE SENSOR LOOP.**

1. If either of the two hardwired loops are going to be used, install the contacts and route the loop wire to the Control Panel's wall cutout.
2. If end-of-line supervision is required for the loop, install a 2.2K ohm resistor (not supplied) as shown in the loop illustration.

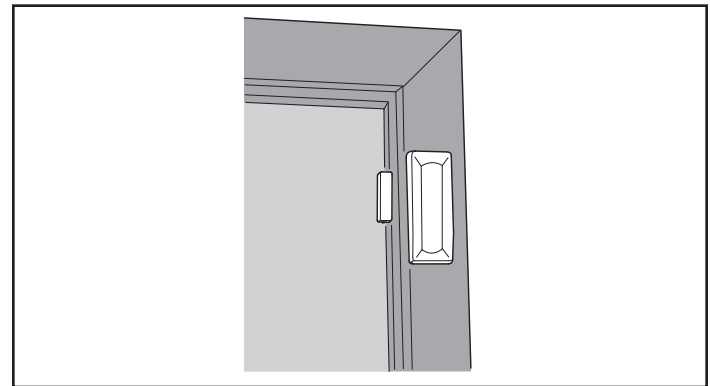

Figure 8. Typical Door Sensor Installation

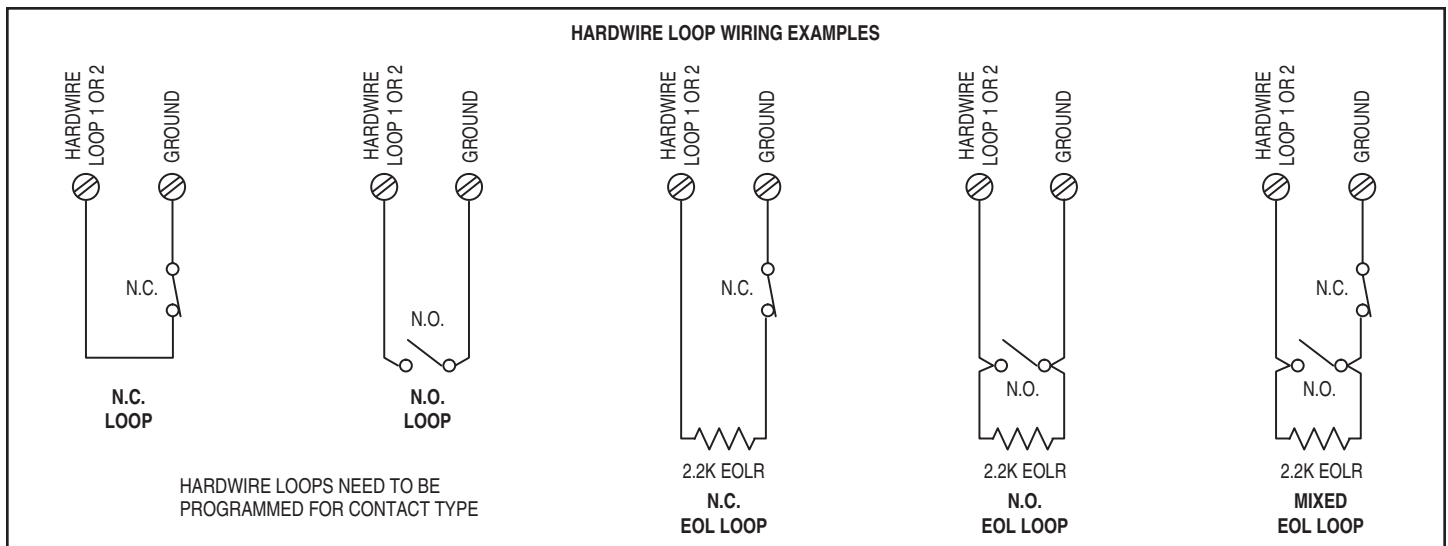

Figure 9. Hardwired Loop Wiring

Remote Alarm Sounder

The Control Panel provides two terminals for an optional connection to a remote electronic alarm sounder. **DO NOT CONNECT AN ELECTROMECHANICAL BELL TO THESE TERMINALS.** The bell terminals can be supervised. If bell trouble reporting is enabled and the wire between the Control Panel and sounder is cut, the Control Panel will report bell trouble.

1. Install the remote sounder in a secure location where it can easily be heard.
2. Route wiring from the remote sounder location to the Control Panel's wall cutout.

Solid State Output

The Control Panel provides one solid state output that can be programmed to activate during various conditions. The output can switch up to 250 Ma @ 16 VDC to ground. Refer to Figure 11 for examples of devices wired to the output.

This output will only function while the Control Panel is receiving power from the wall power supply.

1. Install the device to be controlled by the solid state output.
 2. Route wiring from the device location to the Control Panel's wall cutout.
- **WARNING:** Do not connect an electromechanical bell to these terminals. Damage to the output will occur.

Communicator Telephone Line

Both an incoming telephone line and an outgoing telephone line will be connected to the Control Panel. When the communicator activates, all local telephones will be disconnected to prevent an off-hook telephone on the premises from blocking the communicator's call. See Figure 12 for RJ31X jack wiring details.

1. Run a 4-conductor telephone cable from the telephone company demarcation box to the Control Panel mounting plate.
2. At the demarcation box, disconnect the house telephones that are wired to the box output. **DO NOT DISTURB THE TELCO INPUT "DROP" SIDE OF THE BOX OR ANY EARTH GROUNDS.**
3. At the demarcation box, connect the **RED** cable wire to the box **RING**, and the **GREEN** cable wire to the box **TIP**.
4. At the demarcation box, connect the **BLACK** cable wire to the house telephone **RING** wire(s), and the **YELLOW** cable wire to the house telephone **TIP** wire(s).
5. At the Control Panel, connect the cable's **RED** wire to the RJ31X jack's **RING IN** terminal, and the **GREEN** wire to the RJ31X jack's **TIP IN** terminal.
6. At the Control Panel, connect the cable's **BLACK** wire to the RJ31X jack's **RING OUT** terminal, and the **YELLOW** wire to the RJ31X jack's **TIP OUT** terminal.
7. Snap the cover on the jack. Plug one end of the modular cable into the jack and slide it through the hole in the mounting plate into the wall.

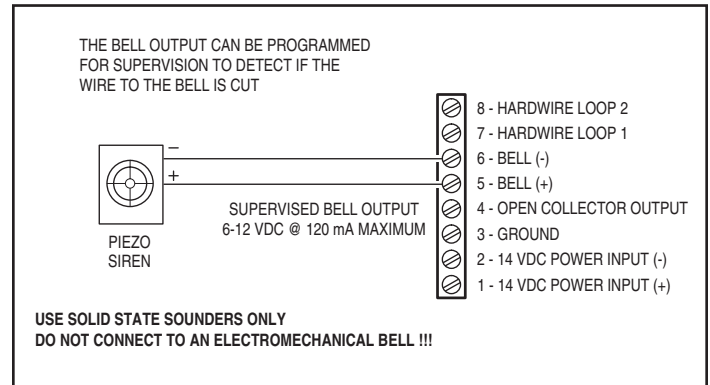

Figure 10. Remote Sounder Wiring

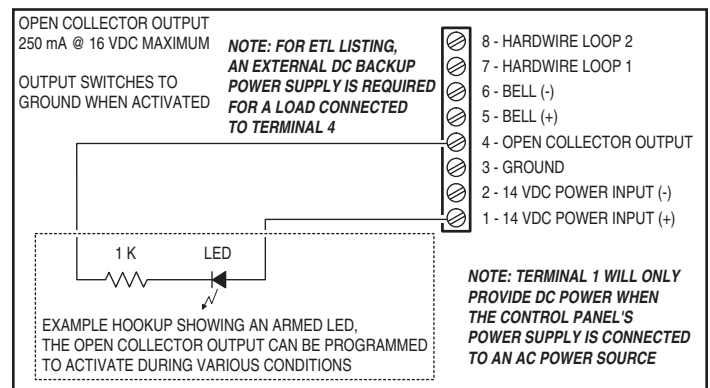

Figure 11. Solid State Output Wiring

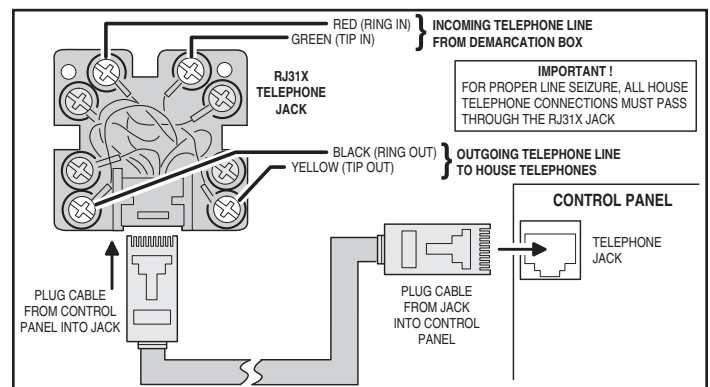

Figure 12. Telephone Jack Wiring

Installation

Optional GSM Module Installation

If using the optional GSM module and one of the GSM antennas. Refer to the following steps:

1. Plug the GSM module into the connector on the Control Panel's circuit board. Secure it with the two screws.
- 2A. If using the Model 2GIG-ANT1 internal antenna, remove the antenna access cover. Route the antenna lead through the opening in the case and place the flat antenna into the slot. Route the antenna wire under the clip behind the speaker and plug the antenna connector into the GSM module. Replace the antenna access cover. See Figure 13.
- ✓ **NOTE:** The routing of the GSM antenna wire is very critical. Route the wire as directed or GSM radio interference will occur inside the Control Panel.
- 2B. If using one of the external antennas, simply plug the antenna connector into the GSM module. The antenna will drop into the wall or mount in the attic with the cable passing through the slot in the Control Panel's mounting plate. See Figures 14 & 15.
- ✓ **NOTE:** The GSM SIM card should have been pre-activated by the factory; if not, contact your service provider. For the GSM module to function with the system, it will have to be activated before it can be enrolled by creating an account with the service provider.

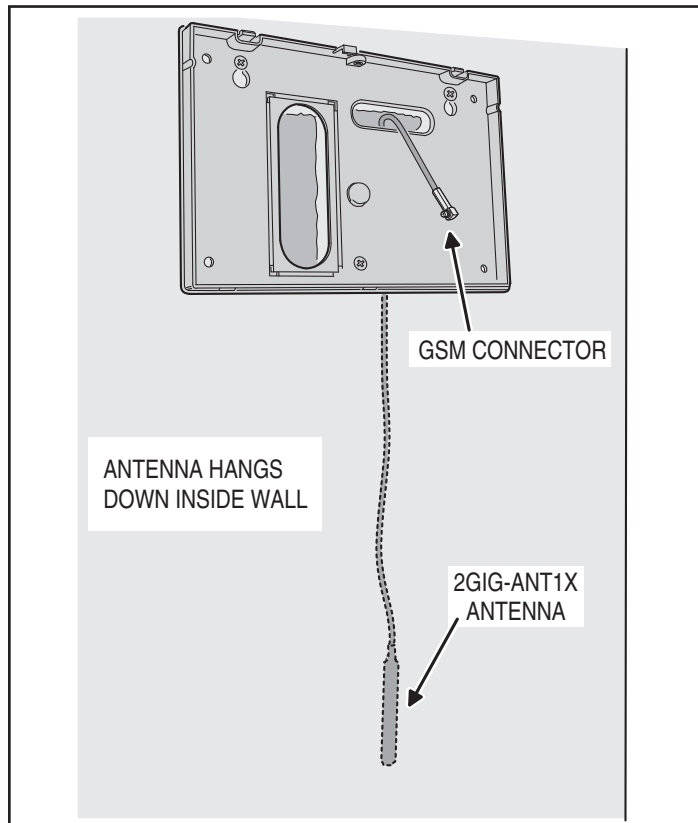

Figure 14. ANT1X In-wall GSM Antenna Installation

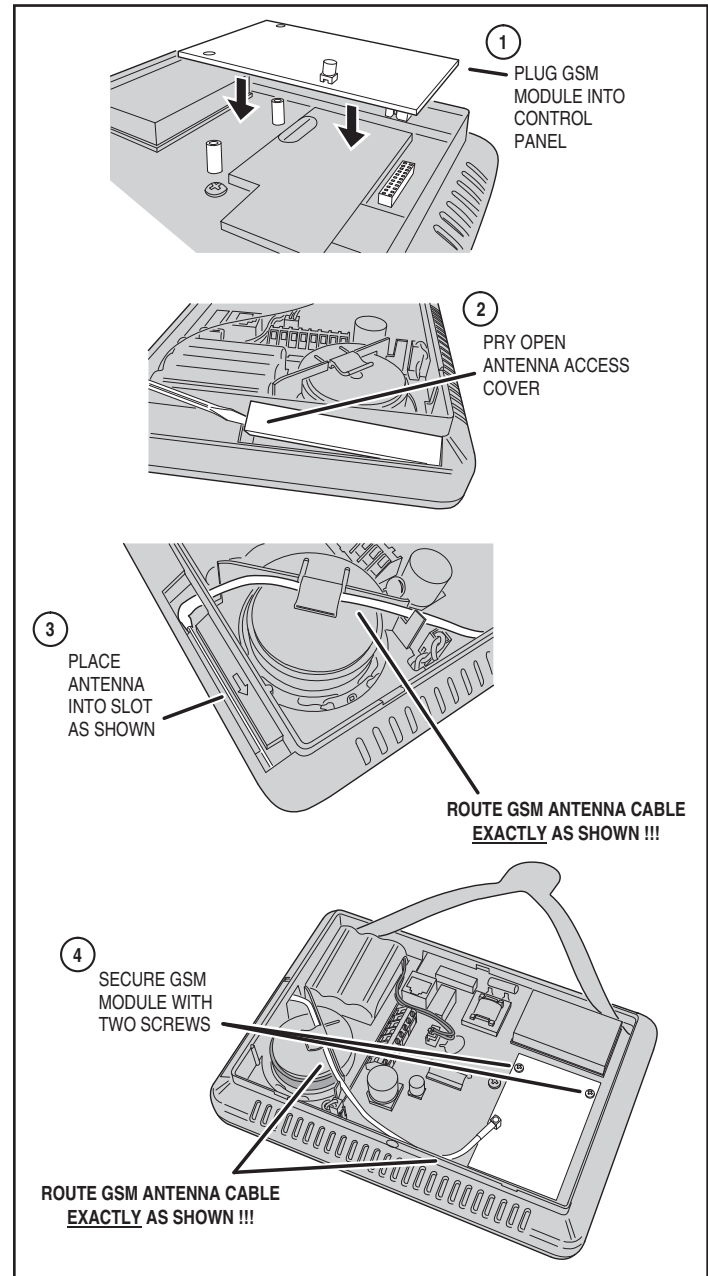

Figure 13. Optional GSM Module Installation

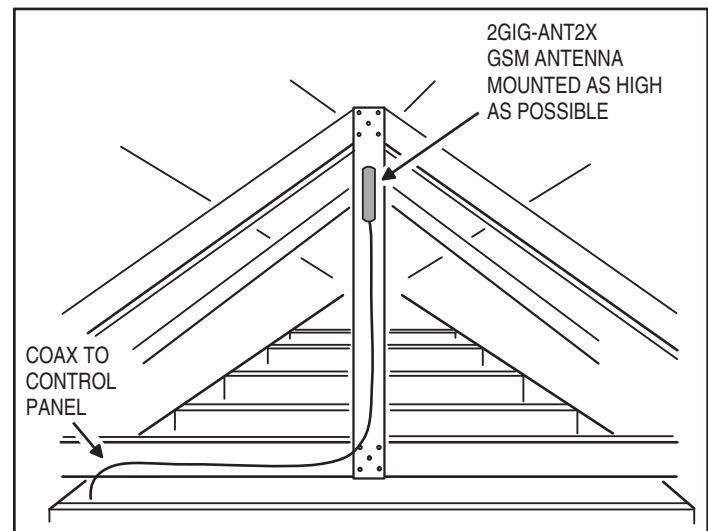

Figure 15. ANT2X Attic GSM Antenna Installation

Control Panel Wiring

The Control Panel includes a “third hand” plastic strap that allows the unit to hang on the mounting plate during installation.

1. Hang the Control Panel on the mounting plate using the “third hand” strap (see Figure 16).
2. Connect the hardwire loop, external sounder, and open collector output wiring (if used) to the Control Panel's terminal block.
3. Plug the telephone line (if used) into the connector on the Control Panel's circuit board.

Backup Battery Connection and Power Supply Wiring

The backup battery connects to the Control Panel's circuit board with a two-pin header assembly.

The power supply features a two-position terminal block for connecting the power supply to the Control Panel power terminals (connection wire not included).

1. Determine a good location where there's a 120 VAC outlet for the plug-in power supply. The 120 VAC outlet must be un-switched (an outlet not controlled by a wall switch). **DO NOT CONNECT THE POWER SUPPLY TO A RECEPTACLE CONTROLLED BY A SWITCH.**
2. Route 2-conductor 18 AWG wire from the power supply location to the Control Panel mounting plate.
3. **BEING CAREFUL TO OBSERVE POLARITY**, connect the power supply's DC + and DC - terminals to the 18 AWG wire. **DO NOT PLUG IN THE POWER SUPPLY YET.**
4. **BEING CAREFUL TO OBSERVE POLARITY**, connect the 18 AWG wire to the Control Panel +14 VDC Terminal #1 (+) and -14 VDC Terminal #2 (-) power input terminals.

✓ **NOTE:** Grounding of the Control Panel is **NOT** required for proper operation.

5. Plug the backup battery pack's connector into the connector on the Control Panel's circuit board. (The Control Panel will not recognize that the battery is connected until AC power is connected to the power supply.)

★ **IMPORTANT:** Applicable regulatory agencies require installation of the extended life backup battery (P/N 2GIG-BATT1X) inside the Control Panel for UL985 Household Fire applications.

Control Panel and Power Supply Mounting

With all the wiring complete, the Control Panel is ready to power up.

1. Swing the Control Panel up, placing the bottom over the lip of the mounting bracket. Push the top of the Control Panel into the mounting bracket until it snaps into place, then secure it with the retaining screw.
2. Peel off the adhesive backing from the power supply retaining bracket and attach the bracket to the outlet with a wall plate screw. Note the orientation for a standard or Decora style outlet (see Figure 19).
3. Spread the retaining bracket ears and plug the Control Panel's power supply into the **un-switched** 120 VAC outlet. Slots are provided on the bracket to secure the power supply with a zip-tie.
4. After about five seconds, the Control Panel will indicate that power has been applied. **IF THE CONTROL PANEL DOES NOT POWER UP, CHECK THE POWER SUPPLY POLARITY!!!**

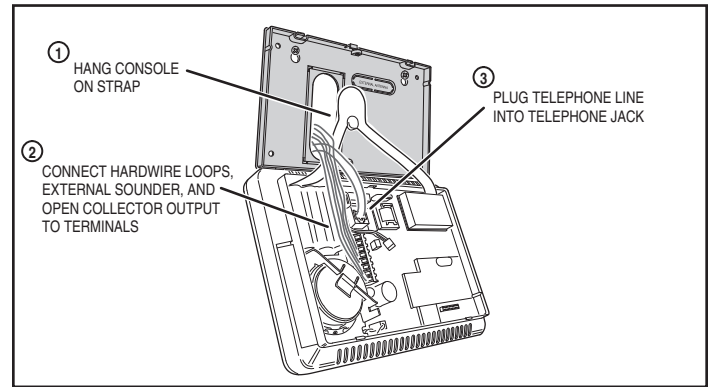

Figure 16. Control Panel Mounting

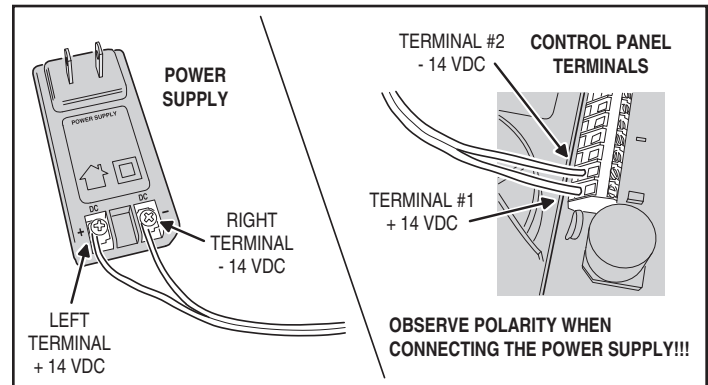

Figure 17. Power Supply Wiring

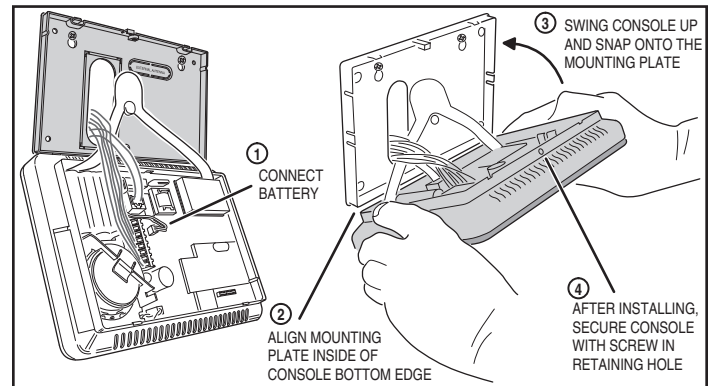

Figure 18. Connecting Battery and Closing Panel

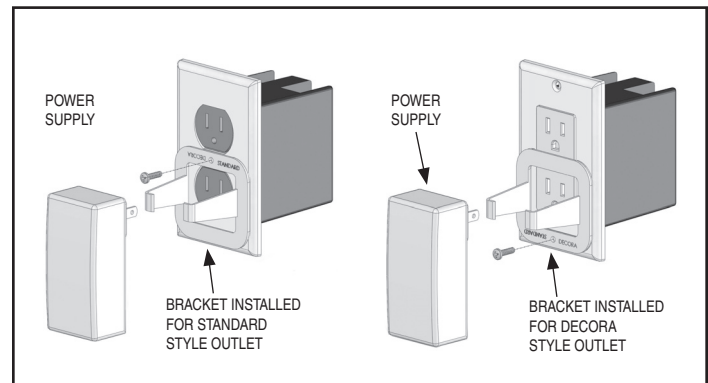



Figure 19. Securing the Power Supply

Main Display Screens

The Control Panel is programmed and operated using the color touch-screen display. The display will show various buttons, indicators, and text to guide the installer and user.

Home Screen

The Home Screen is the top level screen. It shows the system status with icons to indicate system conditions. It also displays the time and date. System information scrolls along the top of the display. The Home Screen displays the **SECURITY** and **SERVICES** buttons. The Silent Control and Display Off buttons are also displayed. When the system is operating, pressing the  button on the Control Panel will display the Home Screen.

Security Screen

The Security Screen shows the system status and offers three buttons for **ARM**, **MENU**, and **STATUS**. The Silent Control button and the time and date are also displayed. If messages, alarm, or trouble alerts are pending, the Security Screen will display buttons indicating the number of pending messages or issues.

Arming Screen

The Arming Screen is used to arm the security portion of the system. It displays the system status and arming buttons for **STAY** and **AWAY**.

An option check box for **ENTRY DELAY** and a Silent Control button are displayed. To arm the system without an entry delay, un-check the **ENTRY DELAY** check box. To arm silently without sounding the Exit Delay beeps, press the Silent Control button. Stay Mode arming always has a silent exit.

Menu Screen

The Menu Screen shows the system status and offers buttons for **ARM** and **TOOLBOX**. If any of the 24-hour emergency options are enabled, an **EMERGENCY** button is displayed. Two option check box buttons for **CHIME** and **VOICE** are displayed.

Installer setup can be accessed using the **TOOLBOX** button.

The **CHIME** button enables/disables chimes for the entire system (chimes can be independently enabled or disabled for each sensor number from the Toolbox).

The **VOICE** button enables/disables voice announcements for the entire system (voice announcements can be independently enabled or disabled for each sensor number from the Toolbox). **Voice announcements always sound during alarm conditions.**

Status Screen

The Status Screen lists system status and any alerts. The date and time of alerts are listed in the displayed log.

One option button for **SILENCE** is displayed; it temporarily stops the voice announcement of the system status during the status display.



Figure 20. The Home Screen



Figure 21. The Security Screen

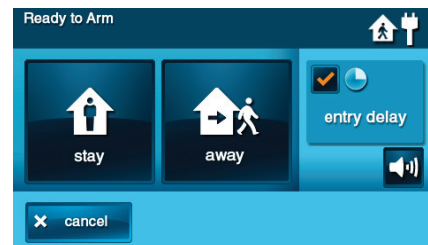

Figure 22. The Arming Screen



Figure 23. The Menu Screen

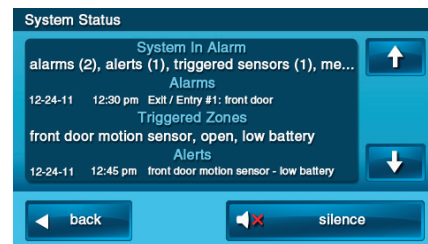

Figure 24. The Status Screen

The Control Panel is programmed using the “toolbox” screens. Users can access basic programming functions. Installers can access basic and Installer Toolbox functions. Users and installers must enter a valid code to access the programming functions in the toolbox. Other functions do not require entering a code.

Toolbox Screens

From the Menu Screen, when the **TOOLBOX** button is pressed, the system will ask for a User Code then display Toolbox Screen one. The arrow button displays Toolbox Screens two and three. Each Toolbox Screen shows option buttons that display sub-menus.

Installer Code Entry Screen

The **INSTALLER TOOLBOX** button goes to the main programming area of the Control Panel and can only be accessed by the installer **while the system is disarmed** by entering a correct access code. **THE INSTALLER CODE CANNOT DISARM THE SYSTEM.**

The system features a special shortcut to help the installer access the Installer Toolbox quickly. Pressing the lower right corner of the Home Screen while the system is disarmed will immediately display a code entry screen. When the correct Installer Code is entered, the system will go directly to the Installer Toolbox.

Installer Toolbox Screen

The Installer Toolbox Screen displays system setup and testing buttons. Main programming is accessed using the **SYSTEM CONFIGURATION** button. The other buttons support system tests and resetting the Control Panel to its programming default values.

System Configuration Screen

When the **SYSTEM CONFIGURATION** button is pressed, the Control Panel will display questions for each programming step. To help the installer program the Control Panel quickly, the programming questions are arranged so that the commonly set values appear early in the question order.

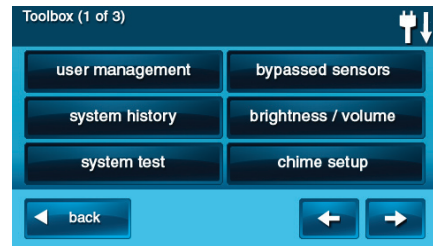

Figure 25. Toolbox Screen One



Figure 26. Toolbox Screen Two

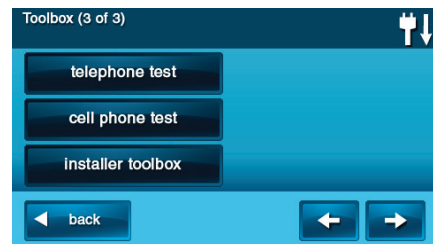

Figure 27. Toolbox Screen Three



Figure 28. Installer Toolbox Code Entry Screen

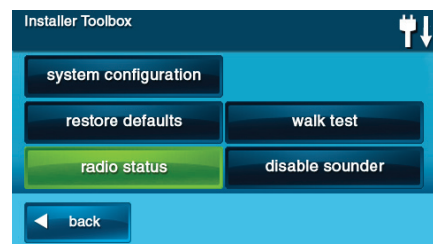

Figure 29. Installer Toolbox Screen

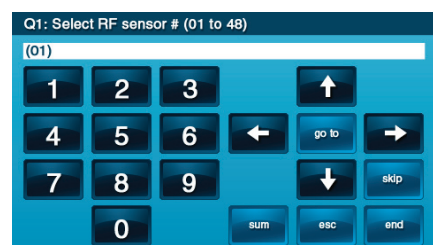

Figure 30. System Configuration Question “Q-1”

System Status Icons

The top line of the Control Panel's display is the status bar that shows the current system mode, the status of the sensors, and any current system trouble alerts. Special icons are displayed to visually show the system's current condition.

AC Power Icon

The AC power icon indicates the Control Panel's AC line power status. The icon displays a white plug when the AC power is present; the icon will display with a red "X" over the white plug when AC power is absent.

Phone Line Failure Icon

If the Control Panel detects that the telephone line is disconnected, the phone line failure icon will be displayed.

Sounder Disable Icon

If the system's internal sounder has been lowered and external sounder has been disabled by the installer for testing, the sounder disable icon will be displayed. Also flashes to indicate silent arming.

Backup Battery Status Icon

If the Control Panel's backup battery tests low, the low backup battery icon will be displayed.

Test Mode Icon

When the system is being tested in Walk Test Mode, the test mode icon will be displayed on the status bar.

Touch Screen Keypad Traffic Icon

When the Control Panel is communicating to a touch screen keypad the up arrow icon is displayed. When a touch screen keypad communicates to the Control Panel the down arrow icon is displayed.

GSM Radio Icon

If the system's optional GSM radio modem is installed, the GSM radio icon will be displayed while the Control Panel is receiving over-the-air firmware updates.

Interior Sensor Open Icon

If an interior sensor is open (or a motion detector has just been activated) the house icon will be displayed on the status bar. As a warning, the icon flashes during arming.

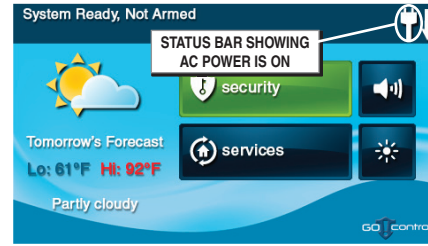

Figure 31. System Status Bar



Figure 32. AC Power Icons



Figure 33. Phone Line Failure Icon



Figure 34. Sounder Disable Icon



Figure 35. Backup Battery Status Icon



Figure 36. Test Mode Icon



Figure 37. Touch Screen Keypad Traffic Icon



Figure 38. GSM Radio Icon



Figure 39. Interior Sensor Open Icon

When the installer is using the System Configuration menus, the Control Panel will present each programming question sequentially. Most programming questions have a single numeric value response or a simple enabled/disabled selection. Some programming questions have sub-options that can be set. These sub-options are displayed for the question selected and can be accessed through navigation keys on the display.

Navigation Arrows & Go To Button

The programming question screens display up, down, left, and right navigation arrows. They are used to move through the programming questions and sub-options.

The **GO TO** button is used to jump directly to a programming question. Pressing **GO TO** will prompt the installer for the two-digit question number to jump to. The **GO TO** button changes to **CANCEL** while waiting for a question number, press **CANCEL** to back out.

Questions without Sub-options

Most of the programming questions do not have sub-options. They navigate as follows. **Questions without sub-options do not display a SKIP button.**

- The ↑ & ↓ arrows select the next or previous programming question.
- The ← & → arrows choose values for the question or move the cursor left and right along the white data entry field.

Questions with Sub-options

Some of the programming questions have sub-options. They navigate as follows. **Questions with sub-options display a SKIP button during the question.**

- The **SKIP** button advances to the next programming question/section.
- The ↑ & ↓ arrows select the next or previous programming sub-question.
- The ← & → arrows choose values for the question or move the cursor left and right along the white data entry field.

Questions with Data to Enter

Some of the programming questions require entering numeric or alphabetic data. For devices that can be named, the Control Panel contains a large vocabulary with words to choose from (see Pg. 19).

- The **INSERT** button displays a word from the vocabulary. The words can be scrolled through using the ← & → arrows, or selected by entering their 3-digit index number.
- The **⌫** (backspace) button moves the cursor to the left, deleting the one character at a time.
- The **⌴** (delete) button deletes a character to the right of the cursor, or any characters that are highlighted.
- The **FWD** (forward) button highlights the next word in multi-word data fields.
- The **BACK** button highlights the previous word in multi-word data fields. The **BACK** button displays the previous screen in some cases.
- When the **SHIFT** button is displayed, pressing it will display alternate characters on the keypad that can be used for data entry.

Other Buttons Displayed

Depending on the programming question, other buttons may be displayed.

- The **ESC** (escape) button serves as an “undo”. Pressing **ESC** restores the value that was previously stored for the question or sub-question.
- The **SUM** (summary) button displays a summary of the values stored for the programming question and sub-options.
- The **END** button displays a summary of the values stored for the entire Control Panel memory.
- The **LEARN** button is used to set the system to receive a sensor’s serial number when transmitted during programming the wireless sensors.
- The **PASTE** button repeats the last sensor serial number entered.
- The **EXIT** button exits programming.

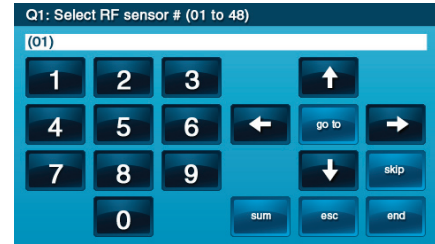

Figure 40. Navigation Arrows & Go To Button

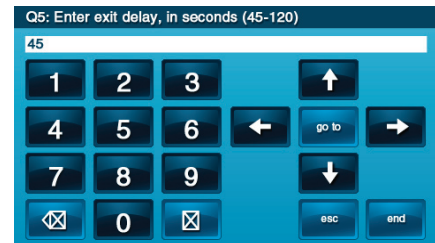

Figure 41. Questions without Sub-options

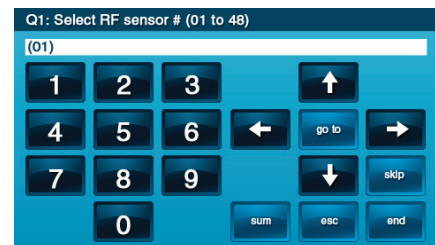

Figure 42. Questions with Sub-options



Figure 43. Questions with Data to Enter

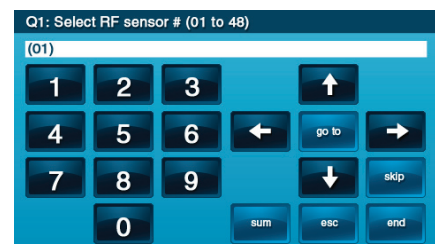

Figure 44. Other Buttons Displayed

Programming Outline

Each system installed will require programming. Most installations being performed by the professional alarm installer for a specific organization will have common values set in every Control Panel reporting to the same Central Station. Other programming values, such as the account number and sensor setup, will be unique for each installation.

Following is an outline to guide the professional alarm installer through the programming of the Control Panel.

If you don't read anything else, read this outline!

Use the following outline in conjunction with this copy of the Installation and Programming Instructions to guide you through the installation.

Because of the many programming options available with this Control Panel, thoroughly reading this manual is very important. Understanding the Control Panel's programming structure will help to save time during each installation.

At this stage, all the wireless and hardwired sensors should be installed, and the Control Panel should be mounted, connected, and powered-up.

1. Start at the Home Screen.
2. Press the logo at the lower right corner of the screen. (The Installer Toolbox can also be accessed via the third screen of the System Toolbox.)
3. Enter the Installer Code (default = 1561) to display the Installer Toolbox.
4. Press **SYSTEM CONFIGURATION** and begin programming as described on Page 18.
5. **USE THE INSTALLATION LOG SHEET TO RECORD PROGRAMMED VALUES FOR THE SYSTEM.**
6. After setting all the required programming values for the sensors and the Control Panel, press **END**, then **EXIT**, to save the changes.
7. After the Control Panel restarts, press **SECURITY, MENU, TOOLBOX**, enter the Master User Code (default = 1111), press **USER MANAGEMENT** and setup the user's codes. Be sure to set a Duress Code as User #8. Press **BACK** when finished.
8. Press **BRIGHTNESS / VOLUME** and set the levels for the installation. The volume setting DOES NOT affect the volume of alarm sounds.
9. Press → to view the second toolbox screen.
10. Press **BACKLIGHT TIMEOUT** and set the display lighting timeout.
11. Press **SET DATE** and **SET TIME** and set the calendar and clock. (If the GSM module is installed, the date and time are set automatically.)
12. Press the ⏪ button to return to the Home Screen.

After all setup and programming, refer to the Operation and User's Guide for details on operating the system. **Check off the programmed options for the system in the User's Guide.**

Be sure to instruct the subscriber on the proper operation of the system, and leave the User's Guide at the installation site for reference.

SIA CP01 Defaults

Several system programmable options have the defaults pre-set to provide compliance with the Security Industry Association CP01 Standard. All other system settings and functions that are required to comply with SIA CP01 are permanently programmed into the Console and cannot be changed. Refer to the table for each programmable option that has a required SIA CP01 programming default.



Figure 45. The Home Screen

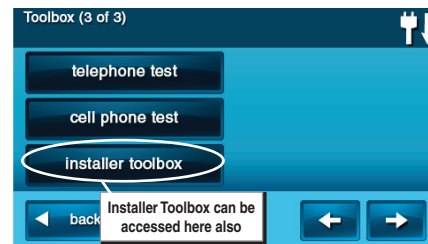

Figure 46. Toolbox Screen Three

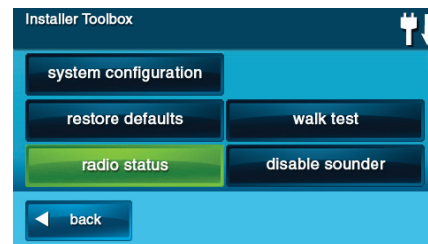

Figure 47. Installer Toolbox Screen

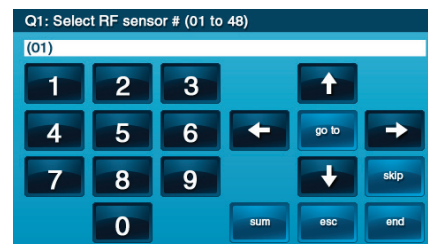

Figure 48. System Configuration Question "Q-1"

PROGRAMMING QUESTION	SIA CP01 DEFAULT	RANGE
Q-1 Wireless Sensor Dialer Delay	30 Seconds	On or Off
Q-2 Wired Sensor Dialer Delay	30 Seconds	On or Off
Q-5 Exit Delay	60 Seconds	45-120 Seconds
Q-6 Entry Delay #1	30 Seconds	30-240 Seconds
Q-7 Entry Delay #2	45 Seconds	30-240 Seconds
Q-10 Call Waiting Disable Code	No Default Code	0-6 Digits
Q-20 Swinger Shutdown Count	1 Trip	1-2 Trips
Q-26 Auto Stay	Enabled	Enabled or Disabled
Q-27 Exit Delay Restart	Enabled	Enabled or Disabled
Q-31 Cancel Time	5 Minutes	6-254 Minutes
Q-32 Cancel Display	Enabled	Enabled or Disabled
Q-35 Abort Window Dialer Delay	30 Seconds	15 or 45 Seconds

Programming Question Table

Q #	QUESTION	DEFAULT
Q-1 SUB-QUESTIONS	Select RF sensor # (01-48)	
	Select RF sensor (#) type	(00) unused
	Select RF sensor (#) equipment type	Varies by RF sensor type (Only shown for some sensor types)
	Select RF sensor (#) equipment code	(0000) other
	Enter RF sensor (#) other equipment code (0-9999)	0 (Only shown if other is selected)
	Enter RF sensor (#) serial number (7 digits)	0000000
	Select RF sensor (#) equipment age (0-1)	(0) new
	Select RF sensor (#) loop number (1-3)	Varies with sensor model selected
	Select RF sensor (#) dialer delay (0-1) ‡	(1) enabled (except for fire & CO)
	Construct RF sensor (#) voice descriptor	No default
	Select RF sensor (#) reports (0-1)	(1) enabled
	Select RF sensor (#) supervised (0-1)	(1) enabled
	Select RF sensor (#) chime (0-5)	(0) disabled
	Q-2 SUB-QUESTIONS	Select wired sensor # (1-2)
Select wired sensor (#) type		(00) unused
Select wired sensor (#) equipment type		Varies by wired sensor type (Only shown for some sensor types)
Enter wired sensor (#) equipment code (0-9999)		0
Select wired sensor (#) equipment age (0-1)		(0) new
Select wired sensor (#) normal state		(0) not used
Select wired sensor (#) dialer delay (0-1) ‡		(1) enabled
Construct wired sensor (#) voice descriptor		No default
Select wired sensor (#) reports (0-1)		(1) enabled
Select wired sensor (#) chime (0-5)		(0) disabled
Q-3 SUB-QUESTIONS	Select fob # (1-8)	
	Select fob (#) used (0-1)	(0) unused
	Select fob (#) equipment code (0000)	(0000) other
	Enter fob (#) other equipment code (0-9999)	0 (Only shown if other is selected)
	Enter fob (#) serial number (7 digits)	0000000
	Select fob (#) equipment age (0-1)	(0) new
	Select fob (#) emergency key (0-4)	(0) disabled
	Select fob (#) key 2 can disarm (0-1)	(1) enabled
	Construct fob (#) voice descriptor	keyfob #
	Select fob (#) arm no delay (0-1)	(0) disabled
Q-4 SUB-QUESTIONS	Select RF keypad # (1-4)	
	Select RF keypad (#) used (0-1)	(0) unused
	Select RF keypad (#) equipment code	(0000) other
	Enter RF keypad (#) other equipment code (0-9999)	0 (Only shown if other is selected)
	Enter RF keypad (#) serial number (7 digits)	0000000
	Select RF keypad (#) equipment age (0-1)	(0) new
	Select RF keypad (#) emergency keys (0-1)	(1) enabled
	Construct RF keypad (#) voice descriptor	keypad #
Q-5	Enter exit delay, in seconds (45-120) ‡	60 seconds
Q-6	Enter entry delay 1, in seconds (30-240) ‡	30 seconds
Q-7	Enter entry delay 2, in seconds (30-240) ‡	45 seconds
Q-8	Select dialer (0-1)	(0) disabled
Q-9	Enter dialing prefix (0-4 digits)	No default
Q-10	Enter call waiting disable code (0-6 digits) ‡	No default
Q-11	Enter CS #1 phone number (0-25 digits)	No default
Q-12	Enter CS #1 account number (4 digits)	No default
Q-13	Select 2-way voice (0-2)	(1) stay on line
Q-14	Select silent panic/burglary listen only (0-1)	(1) enabled
Q-15	Select dialing type (0-1)	(0) touch tone
Q-16	Select police emergency key (0-2)	(1) audible
Q-17	Select fire emergency key (0-1)	(1) audible
Q-18	Select emergency key (0-1)	(1) audible
Q-19	Select quick arming (0-1)	(1) enabled
Q-20	Select swinger shutdown count (1-2) ‡	(1) one trip
Q-21	Select siren supervision time (0-3)	(0) disabled
Q-22	Enter CS lack of usage notification time (0-255)	7 Days
Q-23	Enter radio modem network failure time (0-255)	30 minutes
Q-24	Select radio modem network failure causes trouble (0-1)	(1) enabled
Q-25	Select radio modem network failure reports (0-1)	(1) enabled
Q-26	Select auto stay (0-1) ‡	(1) enabled
Q-27	Select exit delay restart (0-1) ‡	(1) enabled

Q #	QUESTION	DEFAULT
Q-28	Select quick exit (0-1)	(1) enabled
Q-29	Enter periodic test, in days (0-255)	30 days
Q-31	Enter cancel time, in minutes (5-255) ‡	5 minutes
Q-32	Select cancel display (0-1) ‡	(1) enabled
Q-33	Select cross sensor 47-48 (0-1)	(0) disabled
Q-34	Enter cross sensor timeout, in seconds (10-120)	10 seconds
Q-35	Select abort window dialer delay (0-2) ‡	(1) 30 seconds
Q-36	Select burglary bell cutoff (0-4)	(0) 4 minutes
Q-37	Select fire bell cutoff (0-4)	(0) 4 minutes
Q-38	Enter time to detect AC loss, in minutes (0-30)	10 minutes
Q-39	Select random AC loss report time (0-1)	(1) enabled
Q-40	Enter CS #2 phone number (0-25 digits)	No default
Q-41	Enter CS #2 account number (4 digits)	No default
Q-42	Select remote control phone (0-3)	(3) data and voice
Q-43	Enter installer code (4 digits)	1561
Q-44	Select lock installer programming (0-2)	(0) disabled
Q-45	Select lock default programming (0-2)	(0) default all
Q-46	Select trouble doesn't sound at night (0-1) ◆	(1) enabled
Q-47	Select trouble resound after holdoff (0-7)	(0) disabled
Q-48	Enter download csid (6 digits)	000000
Q-49	Select programming mode entry reports to CS (0-1)	(0) disabled
Q-50	Select trouble reports to CS (0-1)	(1) enabled
Q-51	Select manual bypass reports to CS (0-1)	(0) disabled
Q-52	Select AC loss reports to CS (0-1)	(1) enabled
Q-53	Select system low battery reports to CS (0-1)	(1) enabled
Q-54	Select RF low battery reports to CS (0-1)	(1) enabled
Q-55	Select opening reports to CS (0-1)	(0) disabled
Q-56	Select closing reports to CS (0-1)	(0) disabled
Q-57	Select alarm restore reports to CS (0-1)	(0) disabled
Q-58	Select trouble restore reports to CS (0-1)	(1) enabled
Q-59	Select bypass restores reports to CS (0-1)	(0) disabled
Q-60	Select AC restore reports to CS (0-1)	(1) enabled
Q-61	Select system low battery restore reports to CS (0-1)	(1) enabled
Q-62	Select RF low battery restores reports to CS (0-1)	(1) enabled
Q-63	Select phone fail detect (0-1)	(0) disabled
Q-64	Select smart test reports (0-1)	(0) disabled
Q-65	Select RF jam causes trouble (0-1)	(0) disabled
Q-66	Select daylight saving (0-1)	(1) enabled
Q-67	Select daylight saving start month (01-12)	(03) March
Q-68	Select daylight saving start Sunday (1-7)	(2) 2nd
Q-69	Select daylight saving end month (01-12)	(11) November
Q-70	Select daylight saving end Sunday (1-7)	(1) 1st
Q-71	Select system tamper causes trouble (0-1)	(1) enabled
Q-72	Select quick bypass (0-1)	(0) disabled
Q-73	Select disarming keyfob after alarm (alert) (0-1)	(0) disabled
Q-74	Select keyfob arm / disarm confirmation (0-1)	(0) disabled
Q-75	Select auto unbypass for manual bypass (0-1)	(1) enabled
Q-76	Select force bypass reports (0-1)	(0) disabled
Q-77	Select event log (0-3)	(3) all events
Q-78	Select output (00-10) ‡	(11) follows internal sounder alarm
Q-79	Select Z-Wave feature (0-3)	(1) disabled but visible
Q-80	Select Z-Wave switches feature (0-1)	(0) disabled
Q-81	Select Z-Wave thermostats feature (0-1)	(0) disabled
Q-82	Select Z-Wave door locks feature (0-1)	(0) disabled
Q-83	Select temperature display units (0-1)	(0) degrees Fahrenheit
Q-84	Select services require master code (0-1)	(0) disabled
Q-85	Select master user access to zwave toolbox (0-1)	(0) disabled
Q-86	Select disable siren after two-way audio (0-1)	(0) disabled

‡ Default set for SIA CP01 compliance

◆ For UL985 installations, this feature must be disabled

System Sensor Types

Each sensor (wireless or wired) installed in the system is programmed to a specific sensor number and sensor type (zone).

The *sensor number* identifies the specific sensor when it is displayed on the Control Panel, recorded in the event log, or reported to the Central Station. This allows pin-point information about any sensor in the system.

The *sensor type* determines how and when the Control Panel responds to signals from the sensor. Some sensors are armed all the time, others are armed only in certain arming levels, some cause Central Station reports any time they are activated. The sensor's type, along with other programming options, determine this.

Sensor Types (Zones)

(00) Unused

This is the setting for unused sensor numbers that do not have a sensor programmed into them. No system action occurs at any time from this sensor type.

(01) Exit/Entry 1

This sensor type is reserved for doors that are used for exit and entry of the protected premises. When the system is armed in the Away Mode or Stay Mode, the Exit Delay timer starts. There is an Exit Delay regardless of whether the system is armed in Stay Mode or Away Mode. When the Exit Delay timer expires, the system is fully armed.

With the system fully armed, when this type of sensor is triggered, the Entry Delay #1 timer starts. The system must be disarmed before the Entry Delay #1 time expires, or an alarm will occur.

If the Entry Delay is turned off during arming, the exit/entry delay sensors will act as non-delayed instant sensors at the end of Exit Delay.

(02) Exit/Entry 2

This sensor type operates the same as the Exit/Entry 1 sensor type except it will start the Entry Delay #2 timer. This provides a method of having a longer Entry Delay on certain openings, such as a garage door, to provide the user more time to disarm the system.

(03) Perimeter

This sensor type is for perimeter doors and windows that will not be used to enter or exit the protected premises while the system is armed.

An instant alarm will occur when this type of sensor is triggered with the system armed in either the Stay Mode or Away Mode.

(04) Interior Follower

This sensor type is for interior sensors such as motion detectors, mat switches, interior doors, and other sensors that detect human presence inside the protected premises.

This type of sensor is called a "follower" due to its action when the system is armed in the Away Mode. After the Exit Delay expires and the system is armed, if an interior follower sensor is triggered, an instant alarm will occur. If an exit/entry delay sensor is triggered first, the interior follower sensor will also be delayed.

Interior follower sensors are always bypassed and not active when the system is armed in Stay Mode. This allows the premises to be occupied while still protecting the perimeter.

(05) Day Zone

This sensor type is the same as a perimeter zone, except when the system is disarmed, a violation displays a trouble alert on the Console's display.

Common uses for this sensor type are protection of sensitive areas that require notification and possibly a Central Station trouble report, but not an alarm when the system is disarmed.

(06) 24-hour Silent Alarm

This sensor type is active independent of the system arming status. The code for silent panic is sent to the Central Station, but for safety, there are no visual or audible indications locally that this sensor type has been triggered.

(07) 24-hour Audible Alarm

This sensor type is continuously armed 24-hours a day. A sensor programmed to this type will trigger a local alarm and the bell output regardless of the mode the system is in. Typical use would be an audible panic alarm.

(08) 24-hour Auxiliary Alarm

This sensor type is continuously armed 24-hours a day. A sensor programmed to this type will trigger an alarm regardless of the mode the system is in. The bell output will not activate, but the local sounder will continue until it's acknowledged at the Control Panel. Typical use would be for a monitoring device such as a flood or temperature sensor. There is no timeout for the internal sounder, it will continue until a User Code is entered.

(09) 24-hour Fire †

This sensor type is continuously armed 24-hours a day. A sensor programmed to this type will trigger the local alarm fire sounder and the bell output regardless of the mode the system is in. Typical use would be for wireless smoke detectors. This sensor type is always active and cannot be bypassed.

(10) Interior with Delay

This sensor type operates as a delayed sensor when the system is armed in the Away Mode, and when triggered, will start the Entry Delay #1 timer. If the system is armed in Away Mode with no Entry Delay (armed instant), this sensor type will trigger an instant alarm.

If the system is armed in Stay Mode (or Stay Mode with no Entry Delay), this sensor type will be bypassed.

(14) 24-hour Carbon Monoxide †

This sensor type is continuously armed 24-hours a day. A sensor programmed to this type will trigger the local alarm pulse sounder and the bell output regardless of the mode the system is in. Typical use would be for wireless carbon monoxide detectors. This sensor type is always active and cannot be bypassed.

(16) 24-hour Fire with Verification †

This sensor type is continuously armed 24-hours a day. A sensor programmed to this type can trigger the local alarm fire sounder and the bell output regardless of the mode the system is in. Typical use would be for wireless smoke detectors. This sensor type is always active and cannot be bypassed.

For verification, this sensor type must be violated twice in two minutes, or remain violated for 30 seconds. If any other fire sensor (verified sensor type or not) violates within two minutes, both sensors will cause a fire alarm.

(23) No Response Type

This sensor type is a special zone that can be monitored for activity or inactivity by the Central Station. It does not affect security system status.

(24) Silent Burglary

This sensor type is for silent triggering the burglary alarm with perimeter doors and windows that will not be used to enter or exit the protected premises while the system is armed. The Control Panel's sounder and the bell output will not activate.

An instant silent alarm will occur when this type of sensor is triggered with the system armed in either the Stay Mode or Away Mode.

† Indicates Sensor types that are not allowed for hardwired loops.

System Vocabulary Table

#	WORD
002	ABORT
003	AC
004	ACCESS
005	ALARM
006	AND
007	ANNOUNCEMENT
008	AREA
009	ARM
010	ARMED
011	ARMING
012	AT
013	ATTIC
014	AUDIO
015	AUTO
016	AUTOMATION
017	AUXILIARY
018	AWAY
019	BABY'S
020	BACK
021	BASEMENT
022	BATHROOM
023	BATTERY
024	BEDROOM
025	BONUS
026	BREAK
027	BUTTON
028	BYPASS
029	BYPASSED
030	CABINET
031	CANCEL
032	CARBON MONOXIDE
033	CELLAR
034	CELLULAR
035	CELL RADIO
036	CENTER
037	CHECK
038	CHEST
039	CHILDREN'S
040	CHIME
041	CLOSET
042	CODE
043	COMMUNICATIONS
044	COMPUTER
045	CONTROL
046	COOL
047	CRAWL
048	CURRENT
049	DAY
050	DEGREES
051	DEN
052	DETECTOR
053	DIM
054	DINING
055	DISARM
056	DISARMED
057	DOCK
058	DOOR
059	DOWNSTAIRS
060	DRIVEWAY
061	EAST
062	EIGHT
063	EIGHTEEN
064	EIGHTY
065	ELECTRIC

#	WORD
066	ELEVEN
067	EMERGENCY
068	ENTER
069	ENTRANCE
070	ENTRY
071	ERROR
072	EXERCISE
073	EXIT
074	EXIT NOW
075	EXTERIOR
076	EXTERNAL
077	FAILURE
078	FAMILY
079	FAN
080	FIFTEEN
081	FIFTY
082	FIRE
083	FIRE ALERT
084	FIRE DETECTOR
085	FIRST
086	FIVE
087	FLOOD
088	FLOOR
089	FLUID
090	FOIL
091	FOR
092	FORTY
093	FOUR
094	FOURTEEN
095	FOURTH
096	FREEZE
097	FREEZER
098	FRONT
099	FURNACE
100	GAME
101	GARAGE
102	GAS
103	GLASS
104	GLASS BREAK
105	GUEST
106	GUN
107	HALL
108	HALLWAY
109	HANGING
110	HANG UP
111	HEAT
112	HIGH
113	HOME
114	HOUSE
115	ICE
116	INSIDE
117	INSTANT
118	INTERIOR
119	INTRUSION
120	IS
121	KEY
122	KEYFOB
123	KEYPAD
124	KIDS
125	KITCHEN
126	LAUNDRY
127	LEFT
128	LEVEL
129	LIBRARY

#	WORD
130	LIGHT
131	LIGHTS
132	LIQUOR
133	LIVING
134	LOADING
135	LOCK
136	LOFT
137	LOW
138	MAIN
139	MAINTENANCE
140	MASTER
141	MEDICAL
142	MEDICINE
143	MENU
144	MIDDLE
145	MONITOR
146	MOTION
147	MOTION DETECTOR
148	MUD
149	NINE
150	NINETEEN
151	NINETY
152	NORTH
153	NOT
154	NOT READY
155	NO DELAY
156	NO ENTRY DELAY
157	NURSERY
158	OFF
159	OFFICE
160	ON
161	ONE
162	ONE HUNDRED
163	OUTPUT
164	OUTSIDE
165	PANEL
166	PANIC
167	PANTRY
168	PATIO
169	PERIMETER
170	PHONE LINE
171	PLAY
172	POLICE
173	POOL
174	POUND
175	POWER
176	PRESS
177	PREVIOUS
178	PUMP
179	RADIO
180	READY
181	REAR
182	RELAY
183	REMOTE
184	REPEAT
185	RF JAM
186	RIGHT
187	ROOM
188	SAFE
189	SECOND
190	SECURITY
191	SENSOR
192	SENSORS
193	SESSION

#	WORD
194	SET
195	SEVEN
196	SEVENTEEN
197	SEVENTY
198	SHED
199	SHOP
200	SIDE
201	SILENT
202	SIREN
203	SIX
204	SIXTEEN
205	SIXTY
206	SKYLIGHT
207	SLIDING
208	SMOKE
209	SOUNDER
210	SOUTH
211	SPACE
212	SPARE
213	STAIRS
214	STAR
215	STATUS
216	STAY
217	STOP
218	STORAGE
219	STUDY
220	SUMP
221	SUPERVISION
222	SYSTEM
223	TAMPER
224	TEMPERATURE
225	TEN
226	TERMINATED
227	THERMOSTAT
228	THIRD
229	THIRTEEN
230	THIRTY
231	THREE
232	TO
233	TOOL
234	TRANSMITTED
235	TRANSMITTER
236	TROUBLE
237	TURN
238	TWELVE
239	TWENTY
240	TWO
241	UNLOCK
242	UPPER
243	UPSTAIRS
244	USER
245	UTILITY
246	VALVE
247	VOICE
248	WALL
249	WATER
250	WEST
251	WINDOW
252	WIRELESS
253	YARD
254	ZERO
255	ZONE

Installer Programming

RF Sensor Programming

RF Sensor Programming Outline

The Control Panel can be programmed with up to 48 RF sensors of different types. In addition to the 48 multi-purpose RF sensors, eight RF remote control key fobs and four RF remote control keypads can be programmed into the system.

Programming the RF sensors into the Control Panel involves selecting the sensor number for a particular device, selecting the RF sensor type, setting or learning the RF sensor's serial number, and selecting the other options for the sensor.

- RF sensors #1 - #48 report as system sensors #1 - #48

Refer to Figure 49 for an outline of the steps required to program RF sensors into the Control Panel. The options that can be set for each RF sensor are:

- **Sensor Number** — Sensor number 01-48
- **Sensor Type** — Exit/entry, perimeter, interior, etc.
- **Sensor Equipment Type** — Certain sensor types will ask for equipment type
- **Sensor Equipment Code** — Sensor model (door/window, PIR, smoke detector, etc.)
- **Sensor Other Equipment Code** — Enter special equipment code (only shown for sensors set as “other”)
- **Sensor Serial #** — Serial number labeled on sensor; manually enter or “learn” by sending signal
- **Sensor Equipment Age** — New install or existing sensor
- **Sensor Loop Number** — Built-in contacts or external contacts on DW10 door/window sensor
- **Sensor Dialer Delay** — Delayed or instant communicator reports for the sensor (delay time is set by dialer abort window)
- **Sensor Voice Descriptor** — Name assigned to the sensor
- **Sensor Reports** — Communicator reports or no communicator reports for the sensor
- **Sensor Supervised** — Control Panel checks for status reports from the sensor, or does not check for status reports
- **Sensor Chime** — Select voice announcement and chime options for the sensor

Q-1 SUB-QUESTIONS

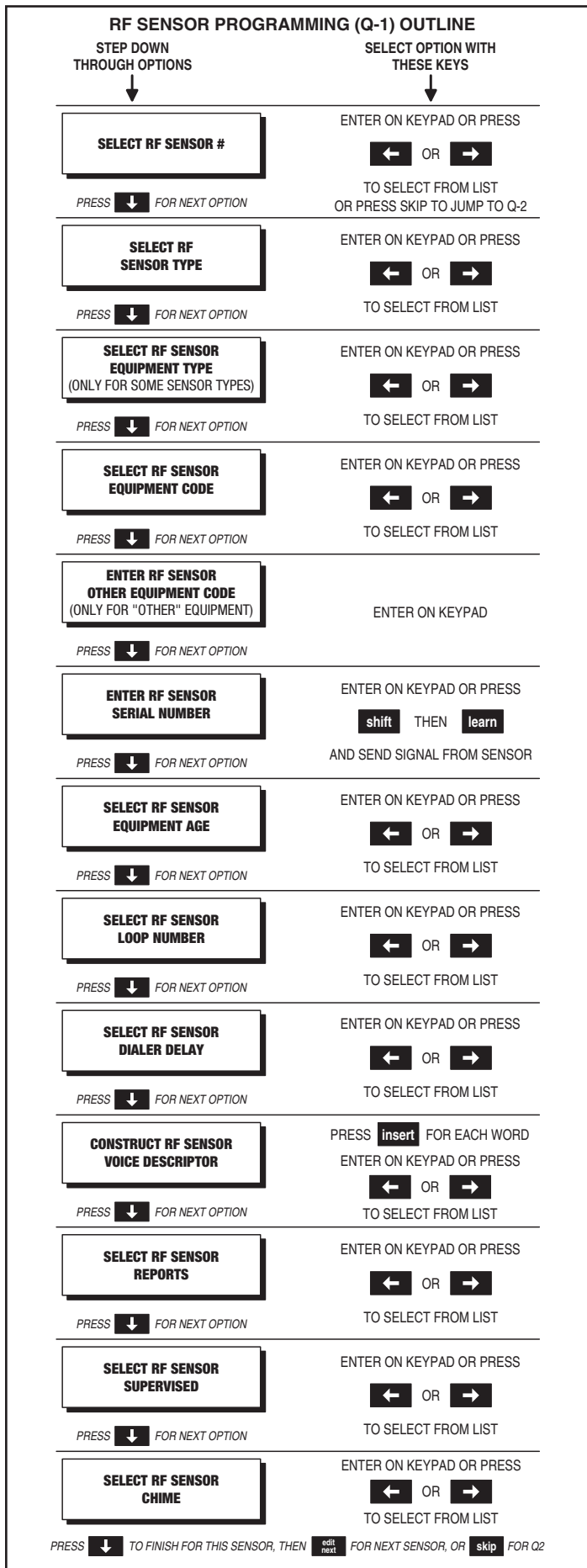

Figure 49. RF Sensor Programming Outline

RF Sensor Summary Screen

After setting all the options for a sensor, the RF sensor summary screen is displayed. The screen can also be displayed for programmed sensors during RF sensor program editing by pressing the **SUM** button.

- The ← and → arrow buttons step through the RF sensor numbers.
- The **EDIT CURRENT** and **EDIT NEXT** buttons return to sensor programming.
- Pressing **SKIP** goes to question number Q-2 (wired sensor programming).



Figure 50. RF Sensor Summary Screen

Installer Programming

RF Sensor Programming Steps

Q-1 Select RF sensor # (01-48)

Up to 48 wireless RF sensors can be used with each Control Panel. The options for each sensor are programmed with sub-option questions.

- Begin by entering the RF sensor number or select it using the ← or → arrows.
 - After selecting the sensor number, program the sensor details by using the ↑ and ↓ arrows to select each of the sub-options.
- ✓ *NOTE: To skip RF sensor programming, press **SKIP** to jump from question Q-1 to question Q-2 (wired sensor programming).*

Select RF sensor (#) type DEFAULT: Unused (00)

Each RF sensor needs to be assigned to a sensor type. The sensor type determines how and when the Control Panel responds to signals from the sensor.

Use this step to assign the sensor to a sensor type (zone).

- Select the sensor type that matches the sensor's function using the ← or → arrows, or enter the sensor type number directly on the keypad.

SENSOR TYPES
(00) unused
(01) exit/entry 1
(02) exit/entry 2
(03) perimeter
(04) interior follower
(05) day zone
(06) 24-hour silent alarm
(07) 24-hour audible alarm
(08) 24-hour auxiliary alarm
(09) 24-hour fire
(10) interior with delay
(14) 24-hour carbon monoxide
(16) 24-hour fire with verification
(23) no response type
(24) silent burglary

Select RF sensor (#) equipment type DEFAULT: Varies by RF sensor type

- ✓ *NOTE: This question is only displayed when certain sensor types are selected. The equipment type selection will affect the sensor's extended reporting code.*

The following sensor types require equipment type selection:

SENSOR TYPE	EQUIPMENT TYPES AVAILABLE
(04) interior follower	(1) = motion (2) = contact
(06) 24-hour silent alarm	(1) = contact (11) = emergency
(07) 24-hour audible alarm	(1) = contact (11) = emergency
(08) 24-hour auxiliary alarm	(1) = contact (6) = freeze (8) = water (10) = temperature (11) = emergency
(10) interior with delay	(1) = motion (2) = contact
(23) no response type	(1) = contact (2) = motion

- Select the equipment type that matches the sensor equipment using the ← or → arrows, or enter the equipment type number directly on the keypad.

Select RF sensor (#) equipment code

DEFAULT: (0000) other

The equipment code is a 4-digit code that is assigned to the model of sensor being used. The Control Panel will display a list of sensor models and their associated 4-digit equipment code.

- Select the model of RF sensor being programmed for this sensor number using the ← or → arrows, or enter the equipment code number directly on the keypad.
- Select "(0000) other" if the sensor model is not shown on the list. The equipment code for the sensor can be entered using the next sub-question.

SENSOR EQUIPMENT CODES
(0000) other
(0862) DW10-345 thin door/window contact
(0863) DW20R-345 recessed door contact
(0869) PIR1-345 PIR with pet immunity
(0864) GB1-345 glass break detector
(0895) SMKT2-345 GE smoke/heat detector (USA/Canada)
(1058) SMKT3-345 2gig smoke detector
(0872) SMKE1-345 smoke detector (USA)
(0871) SMKE1-345C smoke detector (Canada)
(0868) PANIC1-345 panic button remote
(0860) CO1-345 CO detector (USA)
(0859) CO1-345C CO detector (Canada)
(1026) CO3-345 2gig CO detector (USA/Canada)
(0873) TAKE-345 takeover module
(0637) HW D/W "5816"
(0470) HW R-D/W "5818MNL"
(0533) HW PIR "5890"
(0530) HW PIR "5894PI"
(0519) HW Glass Break "5853"
(0589) HW Smoke "5808W3"
(0557) HW Heat Sensor "5809"
(0624) HW Flood Sensor "5821"
(0491) HW Panic Pendant "5802MN2"
(0655) Existing door/window contact
(0609) Existing motion detector
(0475) Existing glass break detector
(0616) Existing smoke detector
(0692) Existing CO detector
(0708) Existing heat sensor
(0556) Existing flood/temp sensor
(1061) GARAGE01 Resolution Products tilt sensor

Enter RF sensor (#) other equipment code (0-9999)

DEFAULT: 0

- ✓ *NOTE: This question is only displayed if "(0000) other" is selected for a sensor's equipment code.*

The equipment code is a 4-digit code that is assigned to the model of sensor being used. If new equipment becomes available, the new equipment code should be entered here if the new equipment is not listed in the Sensor Equipment Codes table above.

- Enter the equipment code number directly on the keypad for the RF sensor. (Enter "0" if the new equipment code is unknown.)

Enter RF sensor (#) serial number (7 digits)

DEFAULT: 0000000

RF sensor serial numbers can be manually entered or learned from the sensor.

- For manual entry, enter the sensor number that was logged for the sensor being programmed. Use the **SHIFT** button to access alpha characters.
- For automatic entry, press **SHIFT**, then press **LEARN**. The Control Panel will wait for a sensor transmission. Trigger the sensor being programmed and the Control Panel will beep four times and learn the sensor's serial number.

If the sensor being learned is already in memory, the Control Panel will display a sensor learning failure screen when the programming changes are being saved.

For certain sensors with more than two loops, the tamper switch must be used to send a signal to the Control Panel during sensor learning. First press of tamper switch will learn as Loop #1, the second press of tamper switch will learn as Loop #2, the third press of tamper switch will learn as Loop #3. **Wait 15 seconds between each press of the tamper switch.** The programmed loop number of the sensor in the Control Panel may need changing to suit the operation of the device. See the Installation Instructions of the sensor for details.

Select RF sensor (#) equipment age (0-1)

DEFAULT: New (0)

The Control Panel can be used with new or existing RF sensors.

- If this RF sensor is new for the installation, leave the default of new (0).
- If this RF sensor is already installed, select existing (1).

✓ *NOTE: If the RF sensor has more than one loop and is being programmed into multiple sensor numbers to support the loops, set only one loop as "new" and the other loops as "existing". This will prevent incorrect inventory of the installed sensors.*

Select RF sensor (#) loop number (1-3)

DEFAULT: Varies with sensor model selected

2GIG-DW10 door/window sensors have two inputs: an internal magnetic contact and an external normally closed hardwired input. Either or both sensor inputs can be used. **Some sensors have three loop inputs.**

When using both the internal magnetic contact AND the external input, **THE MAGNETIC CONTACT AND THE EXTERNAL CONTACT NEED TO BE ASSIGNED A DIFFERENT RF SENSOR NUMBER. BOTH SENSOR NUMBERS WILL SHARE THE SAME SENSOR SERIAL NUMBER.**

- When programming the sensor to use the built-in magnetic contact, set the loop number to (2).
- When programming the sensor to use its hardwired input, set the loop number as (1).
- When programming a 3-loop sensor to use an additional input, set the loop number as (3).
- When entering the sensor number for the sensor's loop two or three, the **PASTE** button can be used to recall the last programmed sensor's serial number. (The sensor number will be filled in automatically if **LEARN** is used.)

Select RF sensor (#) dialer delay (0-1)

DEFAULT: Enabled (1) (Required SIA CP01 Default)

RF sensors can trigger the communicator immediately or after a delay. The delay time is set by the abort window dialer delay programming question Q-35 (the default delay is 30 seconds).

- The default (1) causes delayed dialing for this RF sensor number.
- For immediate dialing for this RF sensor number, select disabled (0).

✓ *NOTE: This setting for CO and smoke detectors is automatically set to disabled (0), and this sub-question is skipped for these sensor types.*

✓ *NOTE: This default can be changed without affecting SIA CP01 compliance.*

Construct RF sensor (#) voice descriptor

DEFAULT: No default

The voice descriptors are the words the Control Panel will announce for this RF sensor if this sensor is programmed for voice annunciation. Up to five words are allowed.

- Press **INSERT** to place a word from the vocabulary into the data entry field.
- Use the ← or → arrows to scroll through the words, or enter the word's 3-digit index number (see vocabulary table on Page 19).
- Press **INSERT** again for the next word. Up to five words are allowed.
- To move between words, press the **FWD** and **BACK** buttons.
- To remove a word, press **DELETE**.

Select RF sensor (#) reports (0-1)

DEFAULT: Enabled (1)

RF sensors can trigger a report to the Central Station or not.

- The default (1) enables reporting for this RF sensor number.
- To prevent reporting for this RF sensor number, select disabled (0).

Select RF sensor (#) supervised (0-1)

DEFAULT: Enabled (1)

When a sensor is set to supervised, the Control Panel will expect regular timed signals from this sensor or else a sensor supervisory trouble alert will occur.

- The default (1) allows supervision for this RF sensor.
- To turn off supervision for this RF sensor, select disabled (0).

✓ *NOTE: Portable sensors such as panic buttons should not be set as supervised if the sensor will be removed from the premises at times.*

Select RF sensor (#) chime (0-5)

DEFAULT: Disabled (0)

Each RF sensor can be set to sound a "ding-dong" chime and/or sound its voice descriptor when the sensor is triggered. This step determines the initial setting for the sensor. The end user can change the chime setting for sensors using **CHIME SETUP** in the User Toolbox.

- The default (0) disables the chime for this RF sensor.
- If a chime and/or voice is required for this RF sensor, choose one of the other chime options:

RF SENSOR CHIME
(0) disabled
(1) voice only
(2) voice with ding-dong #1
(3) ding-dong #2
(4) voice with ding-dong #2
(5) ding-dong #1

Installer Programming

Wired Sensor Programming

Wired Sensor Programming Outline

The Control Panel can be programmed with up to two wired sensors. The wired sensors are hardwired contact loops connected to the loop input terminals on the Control Panel's terminal strip.

✓ **NOTE: WIRED SENSORS CANNOT BE USED FOR A CO OR FIRE SENSOR LOOP!!!**

Programming the wired sensors into the Control Panel involves selecting the sensor number (1 or 2), selecting the wired sensor type, setting the equipment code, loop type (open, closed, or end-of-line resistor), and selecting the other options for the sensor.

- Wired sensors #1 & #2 report as system sensors #49 & #50

WIRED SENSOR REPORTING CODES	
Wired sensor #1	Reports as sensor #49
Wired sensor #2	Reports as sensor #50

Refer to Figure 52 for an outline of the steps required to program wired sensors into the Control Panel. The options that can be set for each wired sensor are:

- Wired Sensor Number** — Sensor number 1 or 2
- Wired Sensor Type** — Exit/entry, perimeter, interior, etc.
- Wired Sensor Equipment Type** — Certain sensor types will ask for equipment type
- Wired Sensor Equipment Code** — 4-digit equipment code that matches installed sensor
- Wired Sensor Equipment Age** — New install or existing sensor
- Wired Sensor Normal State** — normally open, closed, or end-of-line resistor loop
- Wired Sensor Dialer Delay** — Delayed or instant communicator reports for the sensor (delay time is set by dialer abort window)
- Wired Sensor Voice Descriptor** — Name assigned to the sensor
- Wired Sensor Reports** — Communicator reports or no communicator reports for the sensor
- Wired Sensor Chime** — Select voice announcement and chime options for the sensor

Wired Sensor Summary Screen

After setting all the options for a sensor, the wired sensor summary screen is displayed. The screen can also be displayed for programmed sensors during wired sensor program editing by pressing the **SUM** button.

- The ← and → arrow buttons step through the wired sensor numbers.
- The **EDIT CURRENT** and **EDIT NEXT** buttons return to sensor programming.
- Pressing **SKIP** goes to question Q-3 (key fob programming).

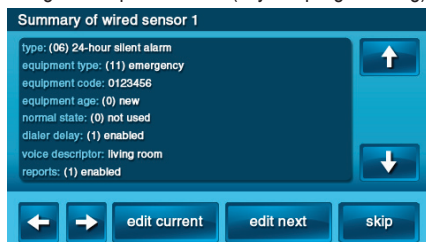

Figure 51. Wired Sensor Summary Screen

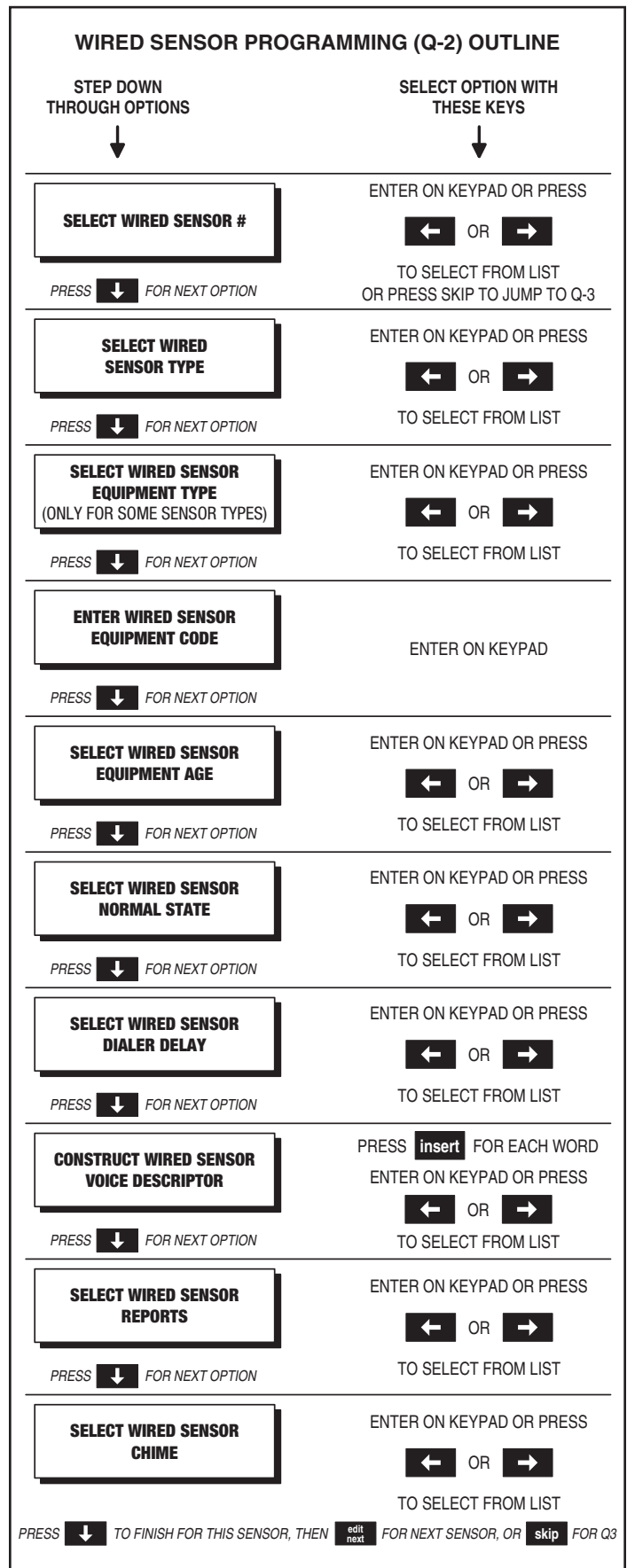

Figure 52. Wired Sensor Programming Outline

Wired Sensor Programming Steps

Q-2 Select wired sensor # (1-2)

Two hardwired loops can be used as sensors with each Control Panel. The options for each wired sensor are programmed with sub-option questions.

- Begin by entering the wired sensor number or select it using the ← or → arrows.
- After selecting the wired sensor number, program the wired sensor details by using the ↑ and ↓ arrows to select each of the sub-options.

✓ *NOTE: To skip wired sensor programming, press **SKIP** to jump from question Q-2 to question Q-3 (RF key fob programming).*

Select wired sensor (#) type

DEFAULT: Unused (00)

Each wired sensor needs to be assigned to a sensor type.

- Select the sensor type that matches the wired sensor's function using the ← or → arrows or enter the sensor type number directly on the keypad.

SENSOR TYPES
(00) unused
(01) exit/entry 1
(02) exit/entry 2
(03) perimeter
(04) interior follower
(05) day zone
(06) 24-hour silent alarm
(07) 24-hour audible alarm
(08) 24-hour auxiliary alarm
(10) interior with delay
(23) no response type
(24) silent burglary

Select wired sensor (#) equipment type

DEFAULT: Varies by wired sensor type

✓ *NOTE: This question is only displayed when certain sensor types are selected. The equipment type selection will affect the sensor's extended reporting code.*

The following sensor types require equipment type selection:

SENSOR TYPE	EQUIPMENT TYPES AVAILABLE
(04) interior follower	(1) = contact (2) = motion
(06) 24-hour silent alarm	(1) = contact (11) = emergency
(07) 24-hour audible alarm	(1) = contact (11) = emergency
(08) 24-hour auxiliary alarm	(1) = contact (6) = freeze (8) = water (10) = temperature (11) = emergency
(10) interior with delay	(1) = contact (2) = motion
(23) no response type	(1) = contact (2) = motion

- Select the equipment type that matches the sensor equipment using the ← or → arrows, or enter the equipment type number directly on the keypad.
- ✓ *NOTE: This Control Panel does not provide auxiliary accessory output power. Connecting a hardwire PIR using equipment type "motion" will require an external stand-alone battery backed-up power supply for the PIR.*

Select wired sensor (#) equipment code (0-9999)

DEFAULT: (0)

The wired sensor equipment code defines the sensor's manufacturer and type.

- Enter the 4-digit equipment code for the sensor.

Select wired sensor (#) equipment age (0-1)

DEFAULT: New (0)

The Control Panel can be used with new or existing wired sensors.

- If this wired sensor is new for the installation, leave the default of new (0).
- If this wired sensor is already installed, select existing (1).

Select wired sensor (#) normal state

DEFAULT: Not used (0)

The two hardwired loops can be wired for normally open (N/O) or normally closed (N/C) contacts, or for end-of-line (EOL) resistor.

- The default (0) disables this wired sensor.
- To use this wired sensor, select the way the loop is wired:

WIRED SENSOR NORMAL STATE
(0) not used
(1) closed
(2) open
(3) end-of-line resistor

Select wired sensor (#) dialer delay (0-1)

DEFAULT: Enabled (1) (Required SIA CP01 Default)

Wired sensors can trigger the communicator immediately or after a delay. The delay time is set by the abort window dialer delay programming question Q-35 (the default delay is 30 seconds).

- The default (1) causes delayed dialing for this wired sensor number.
- For immediate dialing for this wired sensor number, select disabled (0).

✓ *NOTE: This default can be changed without affecting SIA CP01 compliance.*

Construct wired sensor (#) voice descriptor

DEFAULT: No default

The voice descriptors are the words the Control Panel will announce for this wired sensor if this wired sensor is programmed for voice annunciation. Up to five words are allowed.

- Press **INSERT** to place a word from the vocabulary into the data entry field.
- Use the ← or → arrows to scroll through the words, or enter the word's 3-digit index number (see vocabulary table on Page 19).
- Press **INSERT** again for the next word. Up to five words are allowed.
- To move between words, press the **FWD** and **BACK** buttons.
- To remove a word, press **DELETE**.

Select wired sensor (#) reports (0-1)

DEFAULT: Enabled (1)

Wired sensors can trigger a report to the Central Station or not.

- The default (1) enables reporting for this wired sensor number.
- To prevent reporting for this wired sensor number, select disabled (0).

Select wired sensor (#) chime (0-5)

DEFAULT: (0) Disabled

Each wired sensor can be set to sound a "ding-dong" chime and/or sound its voice descriptor when the sensor is triggered.

- The default (0) disables the chime for this wired sensor.
- If a chime and/or voice is required for this wired sensor, choose one of the other chime options:

WIRED SENSOR CHIME
(0) disabled
(1) voice only
(2) voice with ding-dong #1
(3) ding-dong #2
(4) voice with ding-dong #2
(5) ding-dong #1

Installer Programming

RF Key Fob Programming

RF Key Fob Programming Outline

The Control Panel can be programmed with up to eight RF remote control key fobs.

Programming the RF key fobs into the Control Panel involves selecting the sensor number for a particular device, setting or learning the RF key fob's serial number, and selecting the other options for the sensor.

- RF key fobs #1 - #8 report as system sensors #51 - #58 for opening/closing, emergency, and low battery reports.

RF KEY FOB REPORTING CODES	
RF key fob #1	Reports as sensor #51
RF key fob #2	Reports as sensor #52
RF key fob #3	Reports as sensor #53
RF key fob #4	Reports as sensor #54
RF key fob #5	Reports as sensor #55
RF key fob #6	Reports as sensor #56
RF key fob #7	Reports as sensor #57
RF key fob #8	Reports as sensor #58

Refer to Figure 54 for an outline of the steps required to program RF key fobs into the Control Panel. The options that can be set for each RF key fob are:

- Key Fob Number** — Key fob number 1-8
- Key Fob Used** — Key fob used or not
- Key Fob Equipment Code** — Key fob model
- Key Fob Other Equipment Code** — Enter special equipment code (only shown for key fobs set as "other")
- Key Fob Serial #** — Serial number labeled on key fob; hand enter or "learn" by sending signal
- Key Fob Equipment Age** — New unit or existing key fob
- Key Fob Emergency Key** — Choose function of double-press on top buttons
- Key Fob Can Disarm** — Choose whether a key fob is allowed to disarm the system
- Key Fob Voice Descriptor** — Name assigned to the key fob
- Key Fob Arm No Delay** — Choose if key fob will arm instantly without an Exit Delay
- Key Fob Key 4 Output** — Select action for key fob auxiliary button

RF Key Fob Summary Screen

After setting all the options for a sensor, the key fob summary screen is displayed. The screen can also be displayed for programmed key fobs during key fob program editing by pressing the **SUM** button.

- The ← and → arrow buttons step through the key fob numbers.
- The **EDIT CURRENT** and **EDIT NEXT** buttons return to key fob programming.
- Pressing **SKIP** goes to question Q-4 (RF keypad programming).

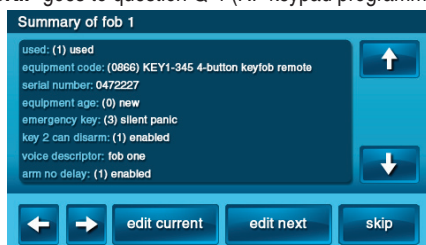

Figure 53. Key Fob Summary Screen

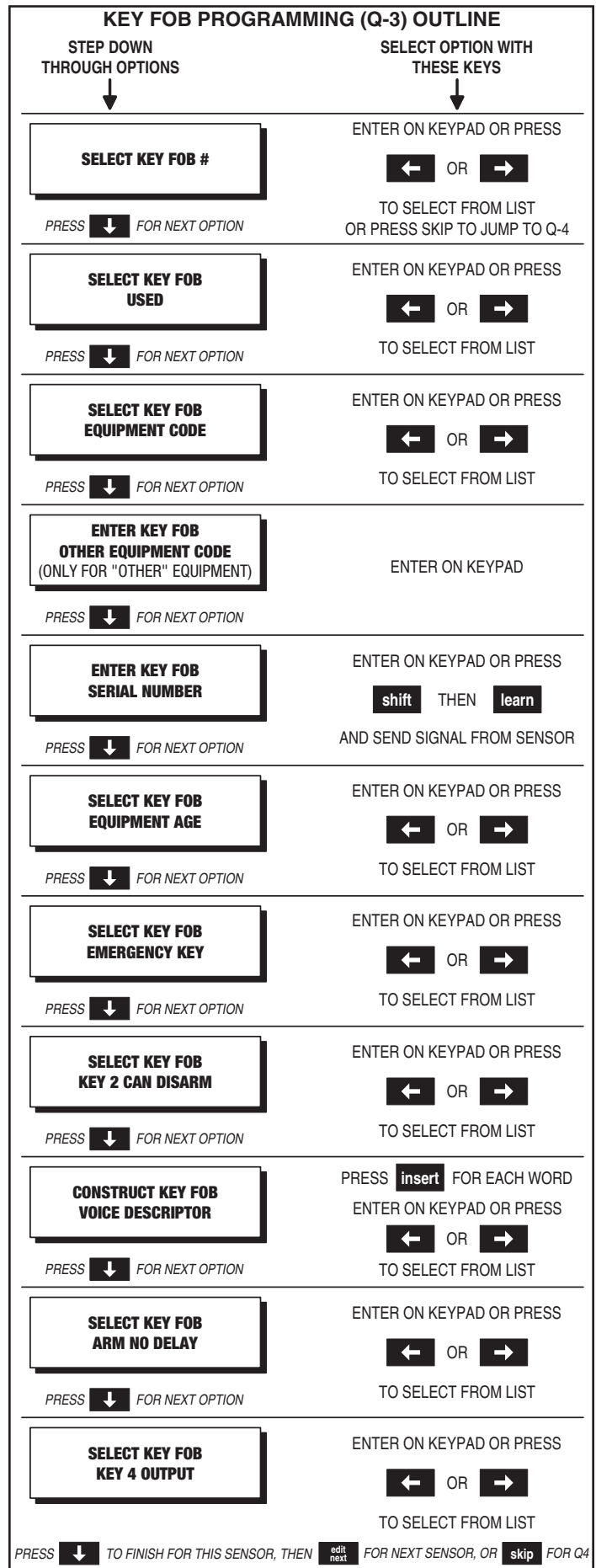

Figure 54. Key Fob Programming Outline

RF Key Fob Programming Steps

Q-3 Select fob # (1-8)

Up to eight wireless 4-button key fobs can be used with each Control Panel. Key fobs reports as sensors 51-58. The options for each fob are programmed with sub-option questions.

- Begin by entering the fob number or select it using the ← or → arrows.
- Program the key fobs by using ↑ and ↓ arrows to select the sub-options.

✓ *NOTE: To skip RF key fob programming, press **SKIP** to jump from question Q-3 to question Q-4 (RF keypad programming).*

Select fob (#) used (0-1)

DEFAULT: Unused (0)

Key fobs can be used with the Control Panel or not.

- The default (0) sets all key fobs as unused (0).
- To enable programming for this key fob, select used (1).

Select key fob (#) equipment code (0-9999)

DEFAULT: (0000) other

The key fob equipment code defines the sensor's manufacturer and type.

- The default is (0000) other.
- Select (0866) KEY1-345 4-button keyfob remote for a 2GIG-KEY1 key fob remote.
- Select (0577) Existing keyfob remote for an existing key fob remote.

✓ *NOTE: Only 2GIG-KEY1 key fobs can be used with this system.*

Enter key fob (#) other equipment code (0-9999)

DEFAULT: 0

✓ *NOTE: This question is only displayed if "(0000) other" is selected for a key fob's equipment code.*

The equipment code is a 4-digit code that is assigned to the model of key fob being used.

- Enter the equipment code number for the key fob.

Enter fob (#) serial number (7 digits)

DEFAULT: 0000000

Key fob serial numbers can be manually entered or learned from the fob.

- For manual entry, enter the fob number that was logged for the fob being programmed. Use the **SHIFT** button to access alpha characters.
- For automatic entry, press **SHIFT**, then press **LEARN**. The Control Panel will wait for a fob transmission. Trigger the fob being programmed and the Control Panel will learn the fob's serial number.

Select fob (#) equipment age (0-1)



DEFAULT: New (0)

The Control Panel can be used with new or existing key fobs.

- If this fob is new for the installation, leave the default of new (0).
- If this fob is already installed, select existing (1).

Select fob (#) emergency key (0-4)

DEFAULT: Disabled (0)

Pressing the  and  buttons on a key fob at the same time for five seconds can trigger an emergency alarm.

- The default (0) disables the emergency function for this fob.
- To enable the emergency function for this fob, select one of the four options:

FOB EMERGENCY KEY FUNCTION
(0) disabled
(1) auxiliary alarm
(2) audible alarm
(3) silent panic
(4) fire

Select fob (#) key 2 can disarm (0-1)

DEFAULT: Enabled (1)

Key fobs can be set to allow disarming the Control Panel with the fob's  button or not. If using a key fob as a stationary wall fob, it can be set to prevent someone from using it to disarm the system.

- The default (1) allows this fob to disarm the system.
- To not allow this fob to disarm the system, select disabled (0).

Construct fob (#) voice descriptor

DEFAULT: Keyfob (#)

The voice descriptor is the words the Control Panel will use for this fob for low battery announcements and log entries. Up to five words are allowed.

- Press **INSERT** to place a word from the vocabulary into the data entry field.
- Use the ← or → arrows to scroll through the words, or enter the word's 3-digit index number.
- Press **INSERT** again for the next word. Up to five words are allowed.
- To remove a word, press **DELETE**.

Select fob (#) arm no delay (0-1)

DEFAULT: Disabled (0)

Key fobs can be set to arm the Control Panel with or without an Entry Delay.

- The default (0) sets this fob to arm the system with an Entry Delay.
- To set this fob to arm the system without an Entry Delay, select enabled (1).

Select fob (#) key 4 output (0-2)

DEFAULT: Disabled (0)

The key fob's auxiliary  button can be used to trigger the Control Panel's open collector output.

- The default (0) disables this fob's auxiliary button.
- To use this fob's auxiliary button, select the output function.

FOB KEY 4 OUTPUT
(0) disabled
(1) toggle output
(2) momentary output

Installer Programming

RF Keypad Programming

RF Keypad Programming Outline

The Control Panel can be programmed with up to four RF remote control keypads or wireless touch screen keypads.

Programming RF keypads into the Control Panel involves selecting the sensor number for a particular device, setting or learning the keypad's serial number, and selecting the other options for the keypad.

- RF keypads #1 - #4 report as system sensors #59 - #62 for emergency, and low battery reports.

RF KEYPAD REPORTING CODES	
RF keypad #1	Reports as sensor #59
RF keypad #2	Reports as sensor #60
RF keypad #3	Reports as sensor #61
RF keypad #4	Reports as sensor #62

- User Codes #1 - #8 are reported for openings and closings.
- User Code #0 is reported for Quick Arming.

Refer to Figure 56 for an outline of the steps required to program RF remote control keypads into the Control Panel. The options that can be set for each RF remote control keypad are:

- RF Keypad Number** — Keypad number 1-4
- RF Keypad Used** — Keypad used or not
- RF Keypad Equipment Code** — Sensor model
- RF Keypad Other Equipment Code** — Enter special equipment code (only shown for sensors set as "other")
- RF Keypad Serial #** — Serial number labeled on keypad; hand enter or "learn" by sending signal
- RF Keypad Equipment Age** — New unit or existing keypad
- RF Keypad Emergency Keys** — Enable or disable keypad emergency keys
- RF Keypad Voice Descriptor** — Name assigned to the keypad

RF Keypad Summary Screen

After setting all the options for a sensor, the RF keypad summary screen is displayed. The screen can also be displayed for programmed RF keypads during RF keypad program editing by pressing the **SUM** button.

- The ← and → arrow buttons step through the RF keypad numbers.
- The **EDIT CURRENT** and **EDIT NEXT** buttons return to RF keypad programming.
- Pressing **SKIP** goes to question Q-5 (Control Panel programming).



Figure 55. RF Keypad Summary Screen

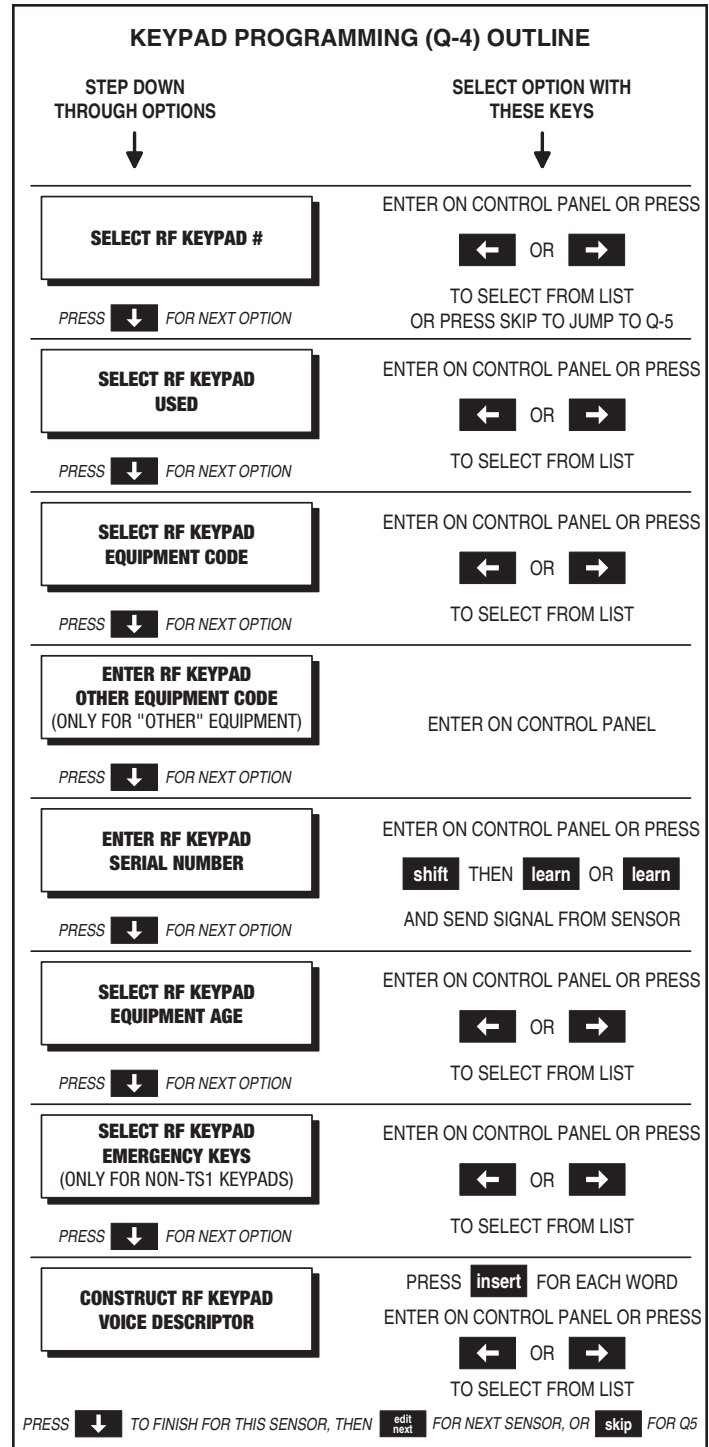

Figure 56. RF Keypad Programming Outline

RF Keypad Programming Steps

Q-4 Select RF keypad # (1-4)

Up to four wireless keypads can be used with each Control Panel. The options for each sensor are programmed with sub-option questions.

- Begin by entering the RF keypad number or select it using the ← or → arrows.
 - Program the RF keypads by using the ↑ and ↓ arrows to select the sub-options.
- ✓ *NOTE: To skip RF keypad programming, press **SKIP** to jump from question Q-4 to question Q-5 (Exit Delay programming).*

Select RF keypad (#) used (0-1)

DEFAULT: Unused (0)

RF keypads can be used with the Control Panel or not.

- The default (0) sets all RF keypads as unused.
- To enable programming for this RF keypad, select used (1).

Select RF keypad (#) equipment code (0-9999)

DEFAULT: (0000) other

The RF keypad equipment code defines the sensor's manufacturer and type.

- The default is (0000) other.
- Select (867) PAD1-345 wireless keypad for a 2GIG-PAD1 RF keypad.
- Select (1059) TS-1 wireless touchscreen keypad for a 2GIG-TS1 Wireless Touch Screen Keypad.

✓ *NOTE: The TS-1 wireless keypad is not for UL985 installations.*

Enter RF keypad (#) other equipment code (0-9999)

DEFAULT: 0

✓ *NOTE: This question is only displayed if "(0000) other" is selected for an RF keypad's equipment code.*

The equipment code is a 4-digit code that is assigned to the model of keypad being used.

- Enter the equipment code number for the RF keypad.

Enter RF keypad (#) serial number (7 digits)

DEFAULT: 0000000

or

RF keypad (#) keypad id (read-only)

RF keypad serial numbers for standard keypads can be manually entered or learned from the RF keypad. Model 2GIG-TS1 wireless touch screen keypads serial numbers can only be learned from the keypad.

Standard Keypads:

- For manual entry, enter the RF keypad number that was logged for the RF keypad being programmed. Use the **SHIFT** button to access alpha characters.
- For automatic entry, press **SHIFT** then press **LEARN**. The Control Panel will wait for an RF keypad transmission. Trigger the RF keypad being programmed, and the Control Panel will learn the RF keypad's serial number.

TS1 Wireless Touch Screen Keypads:

- For 2GIG-TS1 Wireless Touch Screen Keypads press **LEARN**. The Control Panel will display "Pair with TS-1. Initiating learning process." Press the TS1 keypad's **PAIR WITH PANEL** button. Both the TS1 and the Control Panel will display "The learn operation succeeded" when complete.
 - The Control Panel will display "RF keypad (#1-4)" for keypad identification.
 - The TS1 will display "Network ID: xxxx" which is the unique serial number identifying the specific keypad.
 - Press **OK** on both the Control Panel and TS1 to continue.
- ✓ *NOTE: The Model 2GIG-TS1 wireless touch screen keypad will display "The security system is temporarily not operational" after learning the keypad. This is normal, and will be displayed anytime the Control Panel is in system configuration (programming) mode.*

Select RF keypad (#) equipment age (0-1)

DEFAULT: New (0)

The Control Panel can be used with new or existing RF keypads.

- If this RF keypad is new for the installation, leave the default of new (0).
- If this RF keypad is already installed, select existing (1).

Select RF keypad (#) emergency keys (0-1)

DEFAULT: Enabled (1)

✓ *NOTE: This step is not displayed for Model 2GIG-TS1 keypads.*

Standard RF keypads have 24-hour emergency buttons labeled **FIRE** and **POLICE**.

- The default (1) enables this RF keypad's emergency keys.
- To disable this RF keypad's emergency keys, select disabled (0), the keys will not be able to trigger an alarm or report.

✓ *NOTE: The RF keypad's POLICE button will trigger a silent alarm if programming question Q-16 is set to silent panic.*

TO ENSURE SENDING A SIGNAL, BE SURE TO INSTRUCT THE END USER TO PRESS THE RF KEYPAD EMERGENCY KEYS UNTIL THE KEYPAD'S INDICATOR LIGHTS.

Construct RF keypad (#) voice descriptor

DEFAULT: Keypad (#)

The voice descriptor is the words the Control Panel will announce for this RF keypad. Up to five words are allowed.

- Press **INSERT** to place a word from the vocabulary into the data entry field.
- Use the ← or → arrows to scroll through the words, or enter the word's 3-digit index number.
- Press **INSERT** again for the next word. Up to five words are allowed.
- To remove a word, press **DELETE**.

Installer Programming

Control Panel Programming Questions

Q-5 Enter exit delay, in seconds (45-120)

DEFAULT: 60 seconds (Required SIA CP01 Default)

The Exit Delay can be set from 45 to 120 seconds.

- The default (60) sets the Exit Delay to 60 seconds.
 - To change the Exit Delay, enter a value from (45-120) seconds.
- ✓ *NOTE: This default can be changed without affecting SIA CP01 compliance.*

Q-6 Enter entry delay 1, in seconds (30-240)

DEFAULT: 30 seconds (Required SIA CP01 Default)

The Entry Delay #1 can be set from 30 to 240 seconds.

- The default (30) sets the Entry Delay #1 to 30 seconds.
 - To change the Entry Delay #1, enter a value from (30-240) seconds.
- ✓ *NOTE: Per SIA CP01, the combination of the Abort Window Dialer Delay (Q-35) and the Entry Delay (Q-6 or Q-7) cannot exceed one minute.*

Q-7 Enter entry delay 2, in seconds (30-240)

DEFAULT: 45 seconds (Required SIA CP01 Default)

The Entry Delay #2 can be set from 30 to 240 seconds.

- The default (45) sets the Entry Delay #2 to 45 seconds.
 - To change the Entry Delay #2, enter a value from (30-240) seconds.
- ✓ *NOTE: Per SIA CP01, the combination of the Abort Window Dialer Delay (Q-35) and the Entry Delay (Q-6 or Q-7) cannot exceed one minute.*

Q-8 Select dialer (0-1)

DEFAULT: Disabled (0)

The dialer (digital communicator) can be enabled for a monitored system or disabled for a local alarm or when the GSM module is used exclusively for reporting.

- The default (0) sets the dialer as disabled.
 - To turn on the dialer, select enabled (1).
- ✓ *NOTE: If the dialer is disabled with this programming question, telephone line failure detection is also disabled regardless of the setting of the telephone fail detection question Q-63.*

Q-9 Enter dialing prefix (0-4 digits)

DEFAULT: No default

Some telephone PBX systems require a dialing prefix to acquire a dial tone.

- If the telephone system that the Control Panel is connected to requires a dialing prefix, enter up to four digits.
- The **SHIFT** button accesses the pound and star symbols. The **P** button adds a 3-second pause to the dialing.

Q-10 Enter call waiting disable code (0-6 digits)

DEFAULT: No default (Required SIA CP01 Default)

If the subscriber's telephone line has call waiting, incoming call tones on the line could interfere with a communicator report to the Central Station. To prevent this, the communicator can send the call waiting disable code before making a report.

- If call waiting is active on the telephone line, enter the call waiting disable code.
- The **SHIFT** button accesses the pound and star symbols. The **P** button adds a 3-second pause to the dialing.

✓ *NOTE: If the first attempt fails, this code will be ignored on the rest of the attempts.*

Q-11 Enter CS #1 phone number (0-25 digits)

DEFAULT: No default

The telephone number for Central Station #1 can be up to 25 digits.

- Enter the Central Station #1 telephone number.
 - The **SHIFT** button accesses the pound and star symbols. The **P** button adds a 3-second pause to the dialing.
- ✓ *NOTE: If a second Central Station telephone number is programmed with question Q-41, the Control Panel will alternate between the two Central Station telephone numbers. After two failed telephone dialing attempts, the Control Panel will try to connect using the GSM radio module if it is installed. If the GSM radio module is not installed, the Control Panel will make eight dialing attempts.*

Q-12 Enter CS #1 account number (4 digits)

DEFAULT: No default

The account number for Central Station #1 is always four digits and can include some alpha characters.

- Enter four digits for the Central Station #1 account number.
- The **SHIFT** button accesses B, C, D, E, and F characters.

Q-13 Select 2-way voice (0-2)

DEFAULT: Stay on line (1)

The Control Panel supports 2-way voice communications between the subscriber and the Central Station operator over the telephone line or the GSM cellular radio (if installed) after an alarm has been reported.

- The default (1) allows 2-way audio over the telephone line or GSM radio.
- Selecting (2) allows 2-way audio over the telephone line or GSM radio during fire and CO alarms.
- To turn off the 2-way audio feature, select disabled (0).

When the Control Panel connects with the operator, it will beep once per second (every six seconds with a GSM connection). The beep alternates between two tones and indicates the panel is waiting for a session command. If the operator fails to issue a command within one minute (three minutes with a GSM connection), the call is terminated. Once the operator presses a command option, the beeps will stop and a 5-minute audio session will start (3-minute audio session with a GSM connection).

When 2-way voice communications have been established, the Central Station operator can use the following telephone keys to control the communications. Each time the operator uses a command key, the session is extended for five additional minutes (three minutes with a GSM connection). During the last minute of communications, the system will beep twice every 15 seconds to indicate that time is running out.

- Pressing **1** enables Talk Mode one-way communication from the CS to the Premises and allows the operator to talk.
- Pressing **2** enables VOX Mode two-way communications from the CS to the premises.
- Pressing **3** enables Listen Mode one-way communication from the premises to the CS.
- Pressing **7** extends the session five minutes without changing the mode of operation.
- Pressing **9** causes the audio session to end and terminates the call.

Q-14 Select silent panic/burglary listen only

DEFAULT: Enabled (1)

The Control Panel supports audio listen-in of the subscriber premises from the Central Station over the telephone line after a silent panic (police emergency), silent burglary, or duress alarm has been reported.

- The default (1) enables audio listen-in after a silent panic, silent burglary, or duress alarm.
- This option is permanently set and cannot be disabled.

Q-15 Select dialing type (0-1)

DEFAULT: Touch tone (0)

The digital communicator can dial using tones or pulse.

- The default (0) is for touch tone (DTMF) dialing.
- For rotary dialing, select pulse (1).

Q-16 Select police emergency key (0-2)

DEFAULT: Audible (1)

The Control Panel's panic emergency button action can be programmed. The panic emergency button is displayed by pressing the Control Panel's  button.

- The default (1) allows the panic emergency button to sound an audible alarm.
- For silent activation, select silent panic (2).
- To disable and not display the panic emergency button, select disabled (0).

✓ *NOTE: Setting this programming question for silent panic (2) will make the POLICE button on all RF keypads silent also.*

Q-17 Select fire emergency key (0-1)

DEFAULT: Audible (1)

The Control Panel's fire emergency button can be enabled or disabled. The fire emergency button is displayed by pressing the Control Panel's  button.

- The default (1) allows the fire emergency button to sound an audible alarm.
- To disable and not display the fire emergency button, select disabled (0).

Q-18 Select emergency key (0-1)

DEFAULT: Audible (1)

The Control Panel's emergency button can be enabled or disabled. The panel's emergency button is displayed by pressing the Control Panel's  button.

- The default (1) allows the emergency button to sound an audible alarm.
- To disable and not display emergency button, select disabled (0).

✓ *NOTE: If all three emergency buttons are disabled, pressing the Control Panel's  button will display a message that the emergency buttons are disabled.*

Q-19 Select quick arming (0-1)

DEFAULT: Enabled (1)

Quick arming allows the subscriber to arm the system without having to enter their User Code. (Quick arming reports as User 0 if open/close reports are sent.)

- The default (1) allows quick arming.
- To turn off quick arming, select disabled (0).

Q-20 Select swinger shutdown count (1-2)

DEFAULT: One trip (1) (Required SIA CP01 Default)

An unwanted series of multiple faults (usually caused by a bad contact or sensor) is called a "swinger". Swinger shutdown sets the maximum number of alarms that any sensor or hardwire loop can trigger during a single arming period.

✓ *NOTE: CO and smoke detector alarms are not limited by the swinger shutdown count. Other types of 24-hour zones are limited by the swinger shutdown count.*

- The default (1) sets the swinger shutdown count at one trip.
- To set the swinger shutdown count to two trips, select (2).

✓ *NOTE: This default can be changed without affecting SIA CP01 compliance.*

Q-21 Select siren supervision time (0-3)

DEFAULT: Disabled (0)

The wiring connection to the external sounder can be supervised. If the wiring to the sounder is cut for 15, 30, or 45 seconds, a bell trouble report can be sent to the Central Station.

- The default (0) disables external sounder supervision.
- To supervise the external sounder wiring, select (1) for 15 seconds; (2) for 30 seconds; or (3) for 45 seconds.

Q-22 Enter CS lack of usage notification time (0-255)

DEFAULT: Seven days (7)

Inactivity reports can be sent to the Central Station if the system has not been armed for a period of days.

- The default (7) sets the lack of usage feature at seven days.
- To change the lack of usage feature duration, select (1-255) days.
- To turn off the lack of usage feature, select disabled (0).

Q-23 Enter radio modem network failure time (0-255)

DEFAULT: 30 minutes

✓ *NOTE: GSM Module must be installed to use this function.*

Sets the amount of time required for triggering a trouble condition if the system detects that the optional GSM radio modem has lost its cellular connection. (After cellular service has been restored for five minutes, the trouble condition will clear.)

- The default (30) sets the failure detection time at 30 minutes.
- To disable radio modem failure detection, select disabled (0).
- To choose a different failure detection time, select (1-255) minutes.

Q-24 Select radio modem network failure causes trouble (0-1)

DEFAULT: Enabled (1)

✓ *NOTE: GSM Module must be installed to use this function.*

Selects whether the control panel will sound and display trouble if the optional GSM radio modem has lost its cellular connection. The trouble sounder can be silenced by the user at the Control Panel (GSM trouble is logged regardless of this setting). When the GSM radio modem connection is restored, the trouble indications will automatically clear.

- The default (1) allows radio modem failure trouble indications.
- To turn off radio modem failure trouble indications, select disabled (0).

Q-25 Select radio modem network failure reports (0-1)

DEFAULT: Enabled (1)

✓ *NOTE: GSM Module must be installed to use this function.*

If the optional GSM radio modem loses its cellular connection, the Control Panel can report the fault and restore via land-line if telephone reporting is enabled.

- The default (1) allows radio modem failure/restore reporting.
- To turn off radio modem failure/restore reporting, select disabled (0).

Q-26 Select auto stay (0-1)

DEFAULT: Enabled (1) (Required SIA CP01 Default)

When auto stay is enabled and the system is armed in the Away Mode, if an exit entry sensor is not violated during the Exit Delay, the system will arm in the Stay Mode.

- The default (1) enables the auto stay feature.
- To turn off the auto stay feature, select disabled (0).

✓ *NOTE: The auto stay feature will not switch the system to Stay Mode if the system is armed to Away Mode using a key fob remote or remotely armed via telephone or computer.*

Installer Programming

Q-27 Select exit delay restart (0-1)

DEFAULT: Enabled (1) (Required SIA CP01 Default)

When Exit Delay restart is enabled, re-entering the premises through an exit/entry door during the Exit Delay will restart the Exit Delay. The restart of the Exit Delay will only occur one time; further violations of an exit/entry sensor will not extend the Exit Delay.

- The default (1) enables the Exit Delay restart feature.
- To turn off the Exit Delay restart feature, select disabled (0).

Q-28 Select quick exit (0-1)

DEFAULT: Enabled (1)

The quick exit feature allows the user to start the Exit Delay while the system is armed. When this feature is enabled, a **QUICK EXIT** button will appear on the Security Screen. Pressing **QUICK EXIT** while the system is armed allows the user to leave through an exit/entry door. After the Exit Delay expires, the system will return to being armed in the mode it was in before (either Stay or Away Mode).

- The default (1) enables the quick exit feature.
- To turn off the quick exit feature, select disabled (0).

Q-29 Enter periodic test, in days (0-255)

DEFAULT: 30 days

Automatic test reports can be sent to the Central Station every certain number of days.

- The default (30) sends an automatic test report every 30 days.
- To set a different period for automatic test reports, select (1-255) days.
- To disable automatic test reports, select (0).

Q-31 Enter cancel time, in minutes (5-255)

DEFAULT: 5 minutes (Required SIA CP01 Minimum)

A cancel report will be sent to the Central Station after an alarm, if the system is disarmed within the programmed time.

- The default (5) sets the cancel time at five minutes.
- For a longer cancel time, select (6-254) minutes.
- To have the Control Panel always send a cancel report when the system is disarmed after an alarm, select (255).

✓ *NOTE: See Q-32 for information on displaying when a cancel report is sent.*

✓ *NOTE: This default can be changed without affecting SIA CP01 compliance.*

Q-32 Select cancel display (0-1)

DEFAULT: Enabled (1) (Required SIA CP01 Default)

A cancel report will be sent to the Central Station after an alarm, if the system is disarmed within the programmed time. The Control Panel can also show on the display that a cancel report was sent.

- The default (1) enables the cancel display feature.
- To turn off the cancel display feature, select disabled (0).

✓ *NOTE: See Q-31 for information on setting the cancel report trigger time.*

✓ *NOTE: This default can be changed without affecting SIA CP01 compliance.*

Q-33 Select cross sensor 47-48 (0-1)

DEFAULT: Disabled (0)

The Control Panel can be programmed so sensors 47 and 48 must both be violated during a set time to trigger an alarm. This is called "cross sensor" verification. When enabled, if only one sensor (47 or 48) is violated, the alarm will **not** trigger, but a trouble report will be sent for the sensor that triggered.

✓ *NOTE: CO and fire zone cannot be used for cross sensors.*

- The default (0) disables the cross sensor feature.
- To use the cross sensor feature, select enabled (1).

✓ *NOTE: See Q-34 for information on setting the cross sensor timeout.*

Q-34 Enter cross sensor timeout, in seconds (10-120)

DEFAULT: 10 seconds

The cross sensor timeout is the maximum period of time allowed between violation of sensors 47 and 48 that will trigger an alarm. If both sensors are violated within this time period, an alarm will be triggered. If both sensors are **not** violated within this time period, an alarm will **not** be triggered.

✓ *NOTE: Cross sensor verification must be enabled with Q-33 for this feature to function.*

- The default (10) sets the cross sensor timeout at 10 seconds.
- To change the cross sensor timeout duration, select (11-120) seconds.

Q-35 Select abort window dialer delay (0-2)

DEFAULT: 30 seconds (1) (Required SIA CP01 Default)

The Control Panel's dialer (digital communicator) delays calling the Central Station to allow the user enough time to cancel a false alarm before it is reported.

- The default (1) sets the dialer delay at 30 seconds.
- To change the dialer delay, select (0) for 15 seconds or (2) for 45 seconds.

✓ *NOTE: Per SIA CP01, the combination of the Abort Window Dialer Delay (Q-35) and the Entry Delay (Q-6 or Q-7) cannot exceed one minute.*

✓ *NOTE: The dialer delay can be disabled per sensor without affecting SIA CP01 compliance. See sensor programming.*

Q-36 Select burglary bell cutoff (0-4)

DEFAULT: 4 minutes (0)

When a burglary alarm is triggered, the bell will sound until the burglary bell cutoff time expires.

- The default (0) sets the burglary bell cutoff time to 4 minutes.
- To change the burglary bell cutoff time, select (1), (2), (3), or (4):

BURGLARY BELL CUTOFF TIME
(0) 4 minutes
(1) 8 minutes
(2) 12 minutes
(3) 16 minutes
(4) Unlimited time

✓ *NOTE: The 24-hour Auxiliary Alarm Zone (08) does not follow the burglary bell cutoff time and will sound the Control Panel's local alarm until a user code is entered. The Auxiliary Alarm Zone does not trigger the external siren (if used).*

Q-37 Select fire bell cutoff (0-4)

DEFAULT: 4 minutes (0)



When a fire alarm is triggered, the bell will sound until the fire bell cutoff time expires.

- The default (0) sets the fire bell cutoff time to 4 minutes.
- To change the fire bell cutoff time, select (1), (2), (3), or (4):

FIRE BELL CUTOFF TIME
(0) 4 minutes
(1) 8 minutes
(2) 12 minutes
(3) 16 minutes
(4) Unlimited time

Q-38 Enter time to detect AC loss, in minutes (0-30)

DEFAULT: 10 minutes (10)

AC power loss will cause an AC power loss alert  to be displayed, and the length of time before it's displayed can be set. **When power returns, the time required before the AC power loss alert  automatically clears is fixed at one minute.**

- The default (10) sets the AC power loss alert display time to ten minutes.
- To change the AC power loss alert display time, enter (0-30) minutes.

✓ *NOTE: After the AC power alert  is displayed or clears, the AC power loss report or AC power restore report can be sent to the Central Station immediately, or at a random time, see Q-39.*

✓ *NOTE: The Control Panel's AC power icon displays the power status immediately. A red "X" over the icon indicates no AC power.*

Q-39 Select random AC loss report time (0-1)

DEFAULT: Enabled (1)

This feature allows the system to report AC power loss and AC power restore at a random time of up to 45 minutes after the event occurs. This helps to reduce Central Station congestion due to a wide-spread power outage affecting many Control Panels at once. The random AC power status report timer is triggered based on the time set by Q-38.

- The default (1) allows random timed AC power reports.
- To turn off random timed AC power reports, select disabled (0).

Q-40 Enter CS #2 phone number (0-25 digits)

DEFAULT: No default

The telephone number for Central Station #2 can be up to 25 digits. Central Station telephone #2 is dialed as backup in case telephone #1 does not connect.

- Enter the Central Station #2 telephone number.
- The **SHIFT** button accesses the pound and star symbols.
The **P** button adds a 3-second pause to the dialing.

Q-41 Enter CS #2 account number (4 digits)

DEFAULT: No default

The account number for Central Station #2 is always four digits and can include some alpha characters.

- Enter four digits for the Central Station #2 account number.
- The **SHIFT** button accesses B, C, D, E, and F characters.

Q-42 Select remote control phone (0-3)

DEFAULT: Data and voice (3)

This setting controls remote telephone access to the system.

The data option is for the installer. It allows access for programming and operating the system with custom PC downloader software.

The voice option is for the subscriber. It allows the subscriber to call the system from an off-site phone, to get the status of the system, and to perform remote commands. These commands are executed by entering touch tones. The status is reported back via voice prompts. A valid User Code is required for remote telephone access. The user will be able to perform the following functions: arm in any mode, disarm, bypass, get system status, and turn on or turn off the open collector output.

If voice access is enabled, to connect to the panel, the subscriber will need to call the telephone number that the Control Panel is connected to, wait for one or two rings, then hang up. The subscriber needs to call again, **within 10-45 seconds**, and the Control Panel will answer the call.

When the panel answers the phone, the user will be prompted to enter their code. If a valid code is entered, the system will announce the current system status. If an invalid code is entered, the panel will ask for the code again. After two invalid attempts, the panel will disconnect. After two calls, with two invalid attempts each, the panel will lock out. The lock out will last for 30 minutes.

- The default (3) enables data and voice access.
- For data only (PC downloader) access, select (1).
- For voice access only, select (2).
- To disable remote access, select (0).

REMOTE CONTROL PHONE MODE
(0) disabled (no remote control phone)
(1) data only
(2) voice only
(3) data and voice

TELEPHONE KEY	REMOTE CONTROL COMMAND
1	System status report
2	Arm the system in Away Mode
3	Arm the system in Stay Mode
4	Disarm the system
5	Turn on the auxiliary output
6	Turn off the auxiliary output
7	Stop the system status report
8	Disconnect (hang up)
9	Repeat command menu
#	Bypass all open sensors and arm system

✓ *NOTE: Remotely arming the system to Away Mode will not start an Exit Delay or activate Auto Stay Mode (if enabled).*

Q-43 Enter installer code (4 digits)

DEFAULT: 1561

The Installer Code is the code required to enter the Installer Toolbox.

- **The default for the Installer Code is 1561.**
- To change the Installer Code, enter a new 4-digit code.
BE SURE TO WRITE DOWN THE NEW CODE !!!

✓ *NOTE: The Installer Code must be unique from any User Codes.*

Installer Programming

Q-44 Select lock installer programming (0-2)

DEFAULT: Disabled (0)

The installer programming lockout feature is provided to prevent takeovers. The Control Panel can be set to limit an installer's access to programming questions after a period of 48 hours. The 48 hour lockout timer starts when the installer exits system configuration mode.

Three options are available: unlimited full access to programming (no lockout), limited access to programming after 48 hours, or no access to programming after 48 hours.

- The default (0) selects unlimited full access to programming (no lockout).
- To deny access to programming after 48 hours, select no access to programming (1).
- To select limited access to programming after 48 hours, select (2). After the system has run for 48 hours, installer will be able to view, but not change, the Central Station phone number, Central Station account number, lock installer programming, download ID, and default lockout fields.

After the 48 hour lockout timer has locked out the system, the timer can be reset through the GSM radio or PC downloader by remotely setting this question Q-44 to (0) or (2). Setting the option to (0) or (2) will restart the 48 hour lockout timer.

Q-45 Select lock default programming (0-2)

DEFAULT: Default all (0)

The Control Panel may be able to be hard reset (or soft reset from the Installer Toolbox) to its factory default values depending on the value entered for this programming question.

The Control Panel is hard reset by pressing and holding the  and  buttons while applying power to the Control Panel.

The default lockout feature is provided to prevent takeovers. Three options are available: allow default of all options, allow default of some but not all options, not allow default of any options.

- The default setting of default all (0) allows resetting the Control Panel to all its factory defaults.
- To allow resetting the Control Panel to all its factory defaults except the Central Station phone number, Central Station account number, lock installer programming, download ID, and default lockout fields, select (1).
- To deny hard and soft resetting of the Control Panel, select default none (2).

If option (1) or (2) is selected, the option will take effect after the system has run for 48 hours. This allows the installer to go back and make changes if required.

Q-46 Select trouble doesn't sound at night (0-1)

DEFAULT: Enabled (1)

The Control Panel will sound trouble beeps caused by AC loss, system low battery, sensor low battery or RF supervision, failure to communicate, Control Panel tamper while disarmed, and GSM radio faults.

To prevent annoying the subscriber, the system can be set to suppress trouble beeps from sounding from 10 pm to 9 am. The trouble(s) will still be displayed and immediately reported to the Central Station, and can be acknowledged, but they won't sound beeps until after 9 am.

If the trouble condition(s) self-clear or are acknowledged before 9 am, no trouble beeps will sound after 9 am (the conditions will still be recorded in the event log).

- The default (1) suppresses trouble beeps from 10 pm to 9 am.
- To allow trouble beeps at any time, select disabled (0).

✓ **NOTE: For UL985 Installations, this feature must be disabled.**

Q-47 Select trouble resound after holdoff (0-7)

DEFAULT: Disabled (0)

Fire and CO sensors are required to re-sound trouble beeps every four hours until the trouble is resolved, even if the trouble is acknowledged at the Control Panel. The Control Panel can be set to delay re-sounding these types of trouble beeps for 1-7 days.

✓ **NOTE: This feature is *not* allowed in UL 985 installations. The setting must be disabled (0) in this grade of installation.**

- The default (0) allows trouble beeps for CO and fire sensors to re-sound every four hours after being acknowledged.
- To delay re-sounding trouble beeps for CO and fire sensors, select (1-7) days.

Q-48 Enter download csid (6 digits)

DEFAULT: 000000

The system supports a 6-digit CSID code that is used for remote telephone programming of the Control Panel. This code is verified when the Control Panel connects with the downloading software. If the CSID code doesn't match the downloading software, the Control Panel will deny the connection.

- The CSID code can be entered manually with this programming question.
- If this field is left with the default (000000), the first time the downloading software connects with the Control Panel, the field will be filled with the software's CSID.

Q-49 Select programming mode entry reports to CS (0-1)

DEFAULT: Disabled (0)

A report can be sent to the Central Station any time installer programming mode is entered and exited.

- The default (0) prevents reporting programming mode entry and exit.
- To report programming mode entry and exit, select enabled (1).

✓ **NOTE: This report can only be sent through the telephone dialer. It is not supported through the GSM radio.**

Q-50 Select trouble reports to CS (0-1)

DEFAULT: Enabled (1)

Trouble reports can be sent to the Central Station when any sensor trouble condition occurs.

- The default (1) allows reporting sensor trouble conditions.
- To not report sensor trouble conditions, select disabled (0).

✓ **NOTE: This setting does not affect trouble reports caused by Control Panel conditions, only trouble reports caused by sensors.**

Q-51 Select manual bypass reports to CS (0-1)

DEFAULT: Disabled (0)



Manual bypass reports can be sent to the Central Station when any sensor has been manually bypassed by the user.

- The default (0) prevents sending manual bypass reports.
- To allow sending manual bypass reports, select enabled (1).

Q-52 Select AC loss reports to CS (0-1)

DEFAULT: Enabled (1)

AC power loss reports can be sent to the Central Station if the Control Panel loses AC power.

- The default (1) allows AC power loss reports.
 - To turn off AC power loss reports, select disabled (0).
- ✓ *NOTE: The AC power will have to be absent from the Control Panel for the time set by programming question Q-38 before the AC power loss trouble alert  is displayed (the default is 10 minutes). If programming question Q-39 is enabled, the actual AC power loss report will occur at a random time of up to four hours after the AC power loss trouble alert  is displayed.*
- ✓ *NOTE: The Control Panel's AC power icon displays the power status immediately. A red "X" over the icon indicates no AC power.*

Q-53 Select system low battery reports to CS (0-1)

DEFAULT: Enabled (1)

Low battery reports can be sent to the Central Station if the Control Panel's battery tests low.

- The default (1) allows Control Panel low battery reports.
- To turn off Control Panel low battery reports, select disabled (0).

Q-54 Select RF low battery reports to CS (0-1)

DEFAULT: Enabled (1)

Sensor low battery reports can be sent to the Central Station if a sensor battery tests low and sends a low battery transmission to the Control Panel.

- The default (1) allows sensor low battery reports.
- To turn off sensor low battery reports, select disabled (0).

Q-55 Select opening reports to CS (0-1)

DEFAULT: Disabled (0)

Opening reports can be sent to the Central Station each time the system is disarmed. The user or key fob number is indicated in the opening report.

- The default (0) prevents opening reports.
- To allow opening reports, select enabled (1).

Q-56 Select closing reports to CS (0-1)

DEFAULT: Disabled (0)

Closing reports can be sent to the Central Station each time the system is armed. The user or key fob number is indicated in the closing report. If Quick Arming is enabled, User #0 is indicated for the closing report.

- The default (0) prevents closing reports.
- To allow closing reports, select enabled (1).

Q-57 Select alarm restore reports to CS (0-1)

DEFAULT: Disabled (0)

Alarm restore reports can be sent to the Central Station after an alarm when either the bell timeout has been reached or the system is disarmed.

If alarm restores are enabled and swinger shutdown is set to two, a restore will be reported if the sensor is closed (normal state) at bell cutoff or becomes closed after bell cutoff. If swinger shutdown is set to one, a restore will only be sent if the sensor is closed at the time of disarm. Restores are not sent if a sensor is in swinger shutdown until the time of disarm and the sensor is closed.

- The default (0) prevents alarm restore reports.
- To allow alarm restore reports, select enabled (1).

Q-58 Select trouble restore reports to CS (0-1)

DEFAULT: Enabled (1)

Trouble restore reports can be sent to the Central Station when any sensor trouble condition clears.

- The default (1) allows trouble restore reports.
- To turn off trouble restore reports, select disabled (0).

Q-59 Select bypass restores reports to CS (0-1)

DEFAULT: Disabled (0)



Bypass restore reports can be sent to the Central Station when any sensor that was force bypassed or manually bypassed gets restored.

- The default (0) prevents bypass restore reports.
- To allow bypass restore reports, select enabled (1).

Q-60 Select AC restore reports to CS (0-1)

DEFAULT: Enabled (1)

AC power restore reports can be sent to the Central Station when the Control Panel regains AC power after an AC power loss.

- The default (1) allows AC power restore reports.
 - To turn off AC power restore reports, select disabled (0).
- ✓ *NOTE: The AC power will have to be restored to the Control Panel for one minute before the AC power loss trouble alert  automatically clears. If programming question Q-39 is enabled, the actual AC power restore report will occur at a random time of up to four hours after the AC power loss trouble alert  has cleared.*
- ✓ *NOTE: The Control Panel's AC power icon displays the power status immediately. A red "X" over the icon indicates no AC power.*

Q-61 Select system low battery restore reports to CS (0-1)

DEFAULT: Enabled (1)

Control Panel low battery restore reports can be sent to the Central Station if the Control Panel battery had tested low and is now OK.

- The default (1) allows Control Panel low battery restore reports.
- To turn off Control Panel low battery restore reports, select disabled (0).

Q-62 Select RF low battery restores reports to CS (0-1)

DEFAULT: Enabled (1)

Sensor low battery restore reports can be sent to the Central Station if a sensor battery had tested low and is now OK.

- The default (1) allows sensor low battery restore reports.
- To turn off sensor low battery restore reports, select disabled (0).

Q-63 Select phone fail detect (0-1)

DEFAULT: Disabled (0)

The system can monitor the telephone line connected to the Control Panel. If the telephone line is shorted or cut, the Control Panel will indicate telephone line trouble by sounding trouble beeps and displaying the no-phone icon.

If the optional GSM radio modem is installed, the telephone line failure will still be reported if this question is enabled.

- The default (0) disables this feature.
 - To turn on this feature, select enabled (1).
- ✓ *NOTE: If the dialer is disabled with programming question Q-8, telephone line failure detection is also disabled regardless of the setting of this programming question.*

Installer Programming

Q-64 Select smart test reports

DEFAULT: Disabled (0)

Smart test reports are a way to reduce Central Station traffic. If smart test reports are enabled and regular periodic test reports are enabled, any non-test report to the Central Station (alarm, restore, trouble, etc.) during the normal operation of the system will reset the periodic test report timer. Periodic test reports would only be sent if the Control Panel has not reported in any way to the Central Station.

- The default (0) prevents smart test reports.
- To allow smart test reports, select enabled (1).

Q-65 Select RF jam causes trouble (0-1)

DEFAULT: Disabled (0)

The system can monitor the Control Panel's sensor receiver and detect whether a transmitter is stuck on the air causing jamming. When jam detect is enabled, the Control Panel will indicate a trouble condition if RF jamming is detected.

- ✓ *NOTE: This programming question only functions if trouble reports are enabled with programming question Q-50.*
- The default (0) disables RF jam detection.
 - To turn on RF jam detection, select enabled (1).

Q-66 Select daylight saving (0-1)

DEFAULT: Enabled (1)

The Control Panel can adjust its displayed clock and internal clock for daylight saving time. If the GSM radio is used, the time will be automatically adjusted regardless of this setting. **The system default is set for post 2007 daylight saving changeover dates.** These dates can be modified in case the daylight saving changeover date moves again.

- The default (1) enables daylight saving time adjustment.
 - To turn off automatic daylight savings adjust, select disabled (0).
- ✓ *NOTE: If required, use programming questions Q-67, Q-68, Q-69, and Q-70 to modify the daylight saving start and stop dates.*

Q-67 Select daylight saving start month (01-12)

DEFAULT: March (03)

- The default (03) sets March as the daylight saving start month.
- To change the start month, enter the month, January - December (01-12), that the new daylight saving time will start.

Q-68 Select daylight saving start Sunday (1-7)

DEFAULT: 2nd Sunday (2)

- The default (2) sets the second Sunday as the daylight saving start week.
- To change the start week, enter the 1st, 2nd, 3rd, 4th, last, second from last, third from last (1-7) as the daylight saving start week.

Q-69 Select daylight saving end month (01-12)

DEFAULT: November (11)

- The default (11) sets November as the daylight saving end month.
- To change the end month, enter the month, January - December (01-12), that the custom daylight saving time will end.

Q-70 Select daylight saving end Sunday (1-7)

DEFAULT: 1st Sunday (1)

- The default (1) sets the first Sunday as the daylight saving end week.
- To change the end week, enter the 1st, 2nd, 3rd, 4th, last, second from last, third from last (1-7) as the daylight saving end week.

Q-71 Select system tamper causes trouble (0-1)

DEFAULT: Enabled (1)

The Control Panel's case has a tamper switch that detects if the case has been opened. The system can be programmed so that a tamper switch activation will cause a trouble indication if the system is disarmed, and an alarm if the system is armed.

- The default (1) allows the Control Panel tamper switch to trigger trouble when the system is disarmed, and alarm when the system is armed.
- To have the system ignore the Control Panel tamper switch, select disabled (0).

✓ *NOTE: The GSM radio does not report tamper when the system is disarmed.*

Q-72 Select quick bypass (0-1)

DEFAULT: Disabled (0)

Normally, sensors that are violated (open) at the time the system is armed will require the user to enter their code to force bypass them. The Control Panel can be programmed so that when the system is armed with open sensors, a code is **not** required to bypass the open sensor(s) and complete the arming.

- The default (0) requires entering a code to bypass sensors.
- To allow bypassing sensors without a code, select enabled (1).

Q-73 Select disarming keyfob after alarm (alert) (0-1)

DEFAULT: Disabled (0)

The system can produce a unique sound when it's disarmed with a key fob after an alarm has occurred. Four beeps will sound from the Control Panel's speaker, four chirps will sound from the external sounder (if installed). This feature serves as a safety alert to the user so they can enter the protected premises with caution.

- The default (0) will not cause a unique sound when disarming after an alarm.
- To cause unique sound when disarming after an alarm, select enabled (1).

Q-74 Select keyfob arm / disarm confirmation (0-1)

DEFAULT: Disabled (0)

The system can produce a unique sound when it's armed or disarmed with a key fob. The Control Panel's speaker will sound one beep when arming and two beeps when disarming. The external sounder (if installed) will sound one chirp when arming and two chirps when disarming (four beeps after an alarm if Q-73 is enabled). This feature indicates to the user that their key fob signal was received by the Control Panel in case other arm/disarm indications (armed LED, etc.) are not available or visible to the user.

- The default (0) will not cause a unique sound when controlled by a key fob.
- To cause a unique sound when controlled by a key fob, select enabled (1).

Q-75 Select auto unbypass for manual bypass (0-1)

DEFAULT: Enabled (1)

Violated (open) sensors can be *manually bypassed* by the user through the User Toolbox or *force bypassed* at the time of arming.

- ☞ Force bypassed sensors automatically have their bypasses removed when the system is disarmed.
- ☞ Manually bypassed sensors can have their bypass automatically removed at disarming or have their bypasses remain in place.
- The default (1) automatically removes bypasses from manually bypassed sensors when the system is disarmed.
- To have manually bypassed sensors remain bypassed when the system is disarmed, select disabled (0).

Q-76 Select force bypass reports (0-1)

DEFAULT: Disabled (0)

The system can report which sensors have been force bypassed by the user when the system is armed. Forced bypassed sensors are always recorded in the event log, regardless of the setting of this programming question.

- The default (0) prevents reporting forced bypassed sensors.
- To report forced bypassed sensors, select enabled (1).

Q-77 Select event log (0-3)

DEFAULT: All events (3)

To control the amount of event log entries, the events that get recorded into the system's event log can be selected by type. This setting filters the events that populate the event log.

- The default (3) records all events in the event log.
- For different event log filtering options, select (0), (1), or (2):

EVENT LOG FILTERS
(0) disabled (no events logged)
(1) all events except open, closing, and bypass
(2) all events except open and closing
(3) all events

Q-78 Select output (00-10)

DEFAULT: Follows internal sounder alarm (11)

(Required SIA CP01 Default)

The system's open collector output is available on the Control Panel's terminal block to connect to an external device. The conditions that will cause the open collector output to activate are programmable.

- Select one activation option for the Control Panel's open collector output:

OPEN COLLECTOR OUTPUT MODE
(00) disabled
(01) activated when armed
(02) activated when disarmed
(03) activated on FTC (failure to communicate)
(04) activated on siren supervision
(05) activated on radio fault
(06) activated on burglary alarm
(07) activated on fire alarm
(08) activated on any alarm
(09) activated on any system trouble
(10) Z-wave activation (Option #10 not currently active)
(11) follows internal sounder alarm
(12) follows exit/entry beeps

Q-79 Select Z-Wave feature (0-3)

DEFAULT: Disabled but visible (1)

The Z-Wave home services feature can be enabled or disabled with various remote control access options.

- The default (1) displays the **SERVICES** button, but will show a message that the feature is currently disabled and the user should call the installer.
- To hide the **SERVICES** button, select disabled and hidden (0).
- To show the **SERVICES** button and disable off-site remote control, select (2).
- To show the **SERVICES** button, with Z-Wave rules disabled and off-site remote control enabled, select (3).

Q-80 Select Z-Wave switches feature (0-1)

DEFAULT: Disabled (0)

Display of the Home Service's **SWITCHES** button can be enabled or disabled.

- ✓ *NOTE: This programming question only functions if the Z-Wave feature enable question Q-79 is set to (2) or (3).*
- The default (0) hides the **SWITCHES** button.
- To display the **SWITCHES** button, select enabled (1).

Q-81 Select Z-Wave thermostats feature (0-1)

DEFAULT: Disabled (0)

Display of the Home Service's **THERMOSTATS** button can be enabled or disabled.

- ✓ *NOTE: This programming question only functions if the Z-Wave feature enable question Q-79 is set to (2) or (3).*
- The default (0) hides the **THERMOSTATS** button.
- To display the **THERMOSTATS** button, select enabled (1).

Q-82 Select Z-Wave door locks feature (0-1)

DEFAULT: Disabled (0)

Display of the Home Service's **DOOR LOCKS** button can be enabled or disabled.

- ✓ *NOTE: This programming question only functions if the Z-Wave feature enable question Q-79 is set to (2) or (3).*
- The default (0) hides the **DOOR LOCKS** button.
- To display the **DOOR LOCKS** button, select enabled (1).

Q-83 Select temperature display units (0-1)

DEFAULT: Degrees Fahrenheit (0)

The Home Service's Z-Wave thermostat display screens can show the temperature in degrees Fahrenheit or degrees Celsius.

- ✓ *NOTE: This programming question only functions if the Z-Wave feature enable question Q-79 is set to (2) or (3) and the thermostat feature is enabled with Q-81.*
- The default (0) displays temperature in degrees Fahrenheit.
- To display temperature in degrees Celsius, select (1).

Installer Programming

Q-84 Select services require master code (0-1)

DEFAULT: Disabled (0)

The **SERVICES** button can be configured to require the use of the master code to access Services.

- The default (0) disables the requirement for the Master User Code to access the **SERVICES** menu.
- To require the use of the Master User Code to access the **SERVICES** menu, select enabled (1).

When enabled then the Master User Code is required to access the Services and the Z-wave device configurations. This keeps unauthorized users from being able to change Z-wave settings, such as temperature, lights and locks.

Q-85 Select master user access to zwave toolbox (0-1)

DEFAULT: Disabled (0)

The Z-Wave Toolbox menu can be set to require the use of the Master User Code or the Installer Code. By default, the Installer Code is required for users to access the Z-Wave Toolbox.

- The default (0) requires the use of the Installer Code to access the Z-Wave Toolbox menu and all of its features, including the Advanced Toolbox.
- To require the use of the Master User Code or the Installer Code to access the Z-Wave Toolbox menu, select enabled (1).

✓ *NOTE: When enabled (1) the Installer code will still be required to access the Advanced Toolbox menu. This prevents end users from adding or removing Z-Wave devices.*

Q-86 Select disable siren after two-way audio (0-1)

DEFAULT: Disabled (0)

This setting enhances system operation in personal emergency applications and also provides the dealer with the option of the siren sounding until the bell cut off or to the end of a two-way-voice session.

- The default (0) will cause the siren to resume after two-way audio (if the bell cut off timer has not expired).
- Enable (1) will cause the siren to shut off after a two-way audio session.

Exiting Programming

After programming the Control Panel, all the changes need to be saved in memory. After saving, the programmed settings will remain in memory, even after a total power loss.

1. After setting all the required programming values for the sensors and the Control Panel, press **END**.
2. Review the Control Panel Summary screen. Use the ↓ and ↑ arrows to scroll through the listing. Verify that each option is set correctly.
3. To save the programming changes, be sure the **SAVE CHANGES** option is checked. To exit *without* saving programming changes un-check the **SAVE CHANGES** option (for verification, an additional confirmation screen will display). Press **EXIT**. The Control Panel will take a few seconds to restart and display the Home Screen.

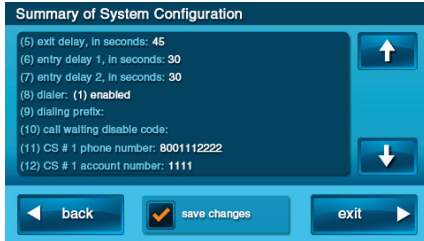

Figure 57. Programming Summary Screen

Customizing the Installation

After programming the Control Panel, go to the User Toolbox and customize the system to suit the installation.

1. After the Control Panel restarts, press **SECURITY, MENU, TOOLBOX** to access the User Toolbox. Enter the Master User Code (default = 1111).



Figure 58. User Toolbox Screen 1 of 3

2. Press **USER MANAGEMENT**.
 3. Setup the User Codes. Press a User button to add, change, or delete a User Code. The system will ask to confirm the code entered. Be sure to set a Duress Code as User #8.
- ✓ *NOTE: User codes 0000 and 0001 are not permitted.*
4. Setup each User Code with the User Access Option Screen. Each User Code can be set to be currently valid or not, or to have conditional validity depending on a time and date schedule. Refer to the User's Guide for details on setting User Code Access Schedules.
 5. Press **BACK** when finished.

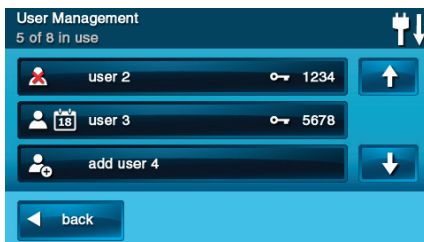

Figure 59. User Management Screen

6. Press **BRIGHTNESS / VOLUME**. Set the level for the display brightness. Set the chime & voice volume. Press **OK** when finished.

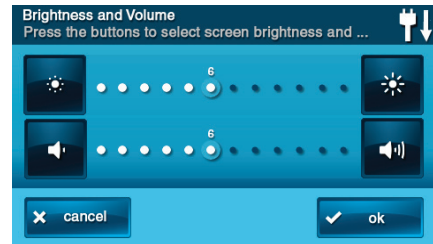

Figure 60. Brightness / Volume Screen

7. Press → to view the second User Toolbox screen.

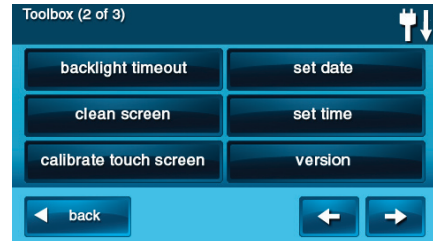

Figure 61. User Toolbox Screen 2 of 3

8. Press **BACKLIGHT TIMEOUT** and set the display lighting timeout. Choose the length of time that the display will remain lit after it is idle. Press **OK** when finished.



Figure 62. Backlight Timeout Screen

9. Press **SET DATE** and **SET TIME** to set the calendar and clock. On the Set Date screen, use the ↓ and ↑ arrows to set the month, day, and year. On the Set Time screen, use the ↓ and ↑ arrows to set the hours, minutes, and AM/PM. Press **OK** when finished. A confirmation screen will show. Verify the time and date, then Press **OK**.

✓ *NOTE: If the GSM radio module is installed and registered, the date and time will be set automatically.*

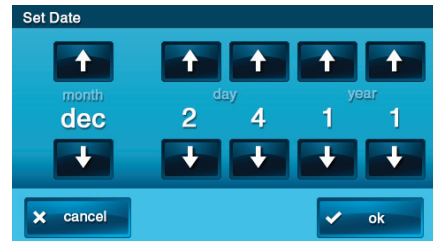

Figure 63. Set Date Screen

10. Press **BACK** to return to the Security Screen or press the ⏪ button to return to the Home Screen.

The installation and installer programming of the Control Panel is now complete. Continue to the next section to test the system.

Installer Testing

Testing the System

After the installation is complete and the Control Panel programming is complete, the system must be tested to ensure proper operation.

System testing is performed through the Installer Toolbox screen.

1. From the Home Screen, press the lower right corner of the screen.
2. Enter the Installer Code (default = 1561) to access the Installer Toolbox.

Sounder Disable/Enable

Since installer testing will cause the Control Panel's internal and external alarm sounder to activate, an option to lower the sounder is available.

1. From the Installer Toolbox Screen, press **DISABLE SOUNDER**.
2. A confirmation screen will be displayed. Press **OK**. Four beeps will sound from the internal sounder, and a short siren will sound from the external sounder. The external siren will be disabled and the internal sounder will be lowered for 30 minutes.
3. A second confirmation screen will be displayed to verify that the test sounds were produced. Press **OK**.
4. While the sounder is disabled, the sounder disable icon will be displayed on the status bar.

The sounder disable will automatically time out after 30 minutes, and the sounder will automatically become active again.

To re-enable the sounder manually, follow these steps:

1. From the Installer Toolbox Screen, press **ENABLE SOUNDER**.
2. A confirmation screen will be displayed. Press **OK**.

Zone Reporting Test

To verify that the Central Station will correctly receive reports from each zone type, perform the following tests:

1. Inform the Central Station that test signals will be sent.
2. Trigger a 24-hour fire sensor (if installed) or press the FIRE emergency button (if enabled), wait about 45 seconds for the report to complete, then disarm the Console.
3. Trigger a 24-hour panic sensor (if installed) or press the PANIC emergency button (if enabled), wait about 45 seconds for the report to complete, then disarm the Console.
4. Trigger a 24-hour emergency sensor (if installed) or press the EMERGENCY emergency button (if enabled), wait about 45 seconds for the report to complete, then disarm the Console.
5. Arm the system then trigger a burglary sensor, wait for the system to go into alarm, wait about 45 seconds for the report to complete then disarm the Console.
6. Check with the Central Station that each zone type was reported, then inform the Central Station that the testing is complete.

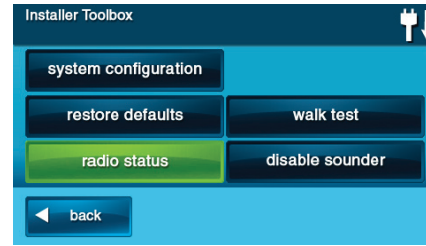

Figure 64. Installer Toolbox

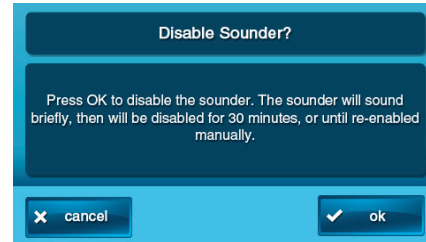

Figure 65. Sounder Disable Screen

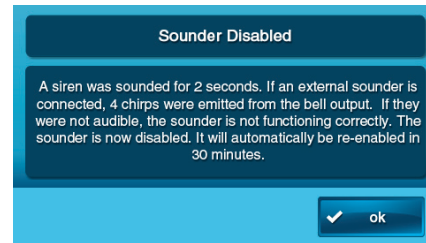

Figure 66. Sounder Disable Confirmation Screen

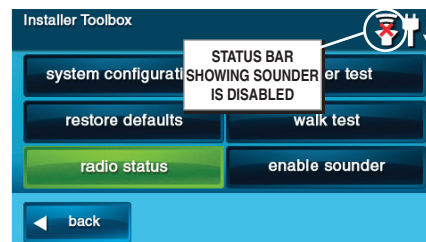

Figure 67. Sounder Disable Icon on Status Bar

Walk Test Mode

Walk Test Mode is for testing all the sensors. It verifies that each sensor is being received correctly by the Control Panel. The walk test also tests the Control Panel's indicators and sounder.

✓ **NOTE:** The Walk Test Mode will automatically end after 25 minutes.

Signal Strength Indicators

An important feature is the received signal strength indicators displayed by the Control Panel for each of the sensors. Even though the Control Panel's RF receiver is high-sensitivity, reception quality of sensors at the Control Panel can vary over time, depending on the amount of background RF noise on the receiver's operating frequency. The signal strength indicators are an important aid to the installer for determining the best location to mount the sensors and Control Panel.

During the walk test, the Control Panel will display the signal strength of the RF transmissions received from each of the sensors. This will help identify any sensors that are received with a weak signal at the Control Panel. Sensors with low signal strength might need to be re-mounted to a location that produces stronger reception at the Control Panel. The higher the sensor signal strength, the better.

During the test, the system will beep every 30 seconds to indicate that the system is in Walk Test Mode. During the last 5 minutes of the test, the system will beep two times every 30 seconds.

✓ **NOTE:** Entering the Walk Test Mode will send a "start test" report to the Central Station. Exiting the Walk Test Mode will send a "stop test" report to the Central Station.

To perform a walk test, follow these steps:

1. From the Installer Toolbox screen, press **WALK TEST**.
2. The **T** icon will display on the Control Panel's status bar and a beep will sound every 30 seconds to indicate that the system is in Walk Test Mode.
3. Each of the sensors and their status will be shown on the on the sensor test screen. Use the **↓** and **↑** arrows to scroll through the sensor list.
4. Activate the first sensor listed and view the result on the display:
 - When a sensor is received by the Control Panel, three beeps will sound and the display will light a green bar to the left of the sensor's name.
 - The received signal strength of the sensor will display as one to five green bars. The more bars, the higher the signal strength.
 - If the signal level is sufficient, a check mark will display for the sensor.
 - **For sensors with multiple loops, wait 15 seconds between triggering each loop.**
5. Continue testing with each of the other sensors listed.
6. After all the sensors have been tested, press the **OK** button to test the Control Panel's indicators and sounder.
7. Press each test item displayed, observe the Control Panel item being tested, and answer the yes/no question for the test.
8. Press **OK** when all items have been tested. The Control Panel will display a summary of the test results.
9. Press **OK** to return to the Installer Toolbox.

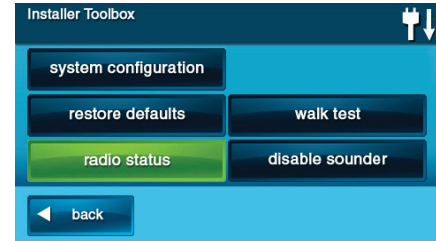

Figure 68. Installer Toolbox Screen

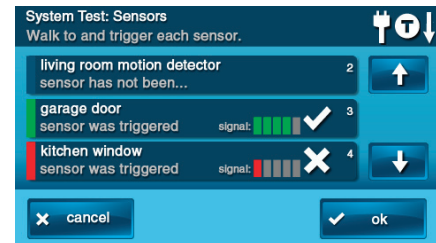

Figure 69. Sensor Test Screen During Testing

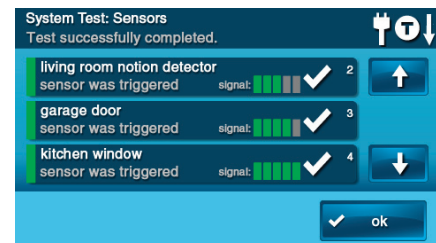

Figure 70. Sensor Test Screen Completed and Passed

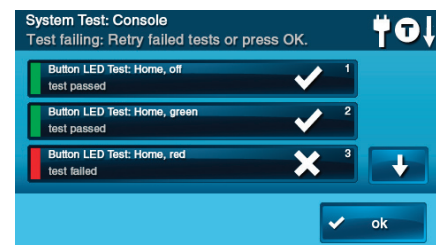

Figure 71. Indicator and Sounder Test Screen

Installer Testing

Radio Status Mode

✓ **NOTE:** GSM Module must be installed to use this function.

The GSM Radio Status screen displays data for the GSM radio (if installed). The screen displays signal strength, serial number, registration status, and other information about the GSM radio module status. The information may be helpful for radio installation troubleshooting.

Follow these steps to check the radio status:

1. From the Installer Toolbox screen, press the **RADIO STATUS** button.
2. The system will display the GSM Radio Info screen. Each test item is displayed, followed with its current condition. Scroll through the info screen with the ↓ and ↑ arrows.
 - Text is displayed in red if the tested signal strength is zero or too low, or the GSM module is not registered.
 - Text is displayed in orange if the connection is idle and the GSM module is registered.
 - Text is displayed in green if the signal strength is good and the GSM module is registered.

GSM Radio Test

A **RUN RADIO TEST** button is provided on the GSM Radio Status screen. Pressing this button will test the GSM cell phone connection to the Central Station.

The same test can also be run using the **CELL PHONE TEST** button on the User Toolbox screen #3.

Follow these steps to test the GSM radio:

1. From the Radio Status screen, press the **RUN RADIO TEST** button.
2. The system will display the Cell Phone Test screen. The top portion of the screen shows the actions that the Control Panel is taking. The bottom portion of the screen shows the results of the actions. Scroll through the status screen with the ↓ and ↑ arrows.
3. When the test is complete, press **OK** to return to the Installer Toolbox.

Telephone Test

The telephone test checks the land-line connection to the Central Station through the Control Panel's built-in digital communicator. The test is accessed through the User Toolbox screen #3.

Follow these steps to test the digital communicator:

1. On toolbox screen #3, press the **TELEPHONE TEST** button.
2. Enter the Master User Code, and the system will display the Telephone Test screen. The top portion of the screen shows the actions that the Control Panel is taking. The bottom portion of the screen shows the results of the actions. Scroll through the status screen with the ↓ and ↑ arrows.
3. When the test is complete, press **OK** to return to the User Toolbox.

Restoring Programming Defaults

To soft reset the Control Panel back to the factory defaults, use the Restore Default option in the Installer toolbox.

✓ **NOTE:** The Control Panel may also be "hard" reset to out-of-the-box factory defaults by pressing and holding the emergency and home buttons while applying power (if not disabled through programming questions Q-44 & Q-45).

Restore Defaults

The Restore Defaults screen provides a method to selectively reset the Control Panel to its default programming values instead of using a full "hard" reset.

Two check box options are available; one or both must be checked:

- If the **ZONES** box is checked, all data for the 48 sensors will be erased and replaced with the default values.
- If the **CONSOLE** box is checked, all the Control Panel programming questions (except Z-Wave questions Q79-Q83) will be erased and replaced with the default values. The User Codes will be erased, the backlight timeout is reset to five minutes, and the brightness/volume settings are reset.

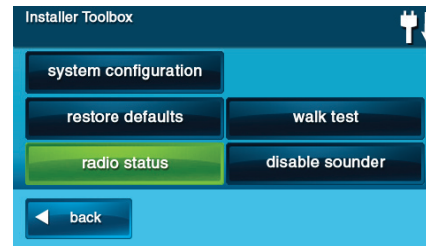

Figure 72. Installer Toolbox Screen

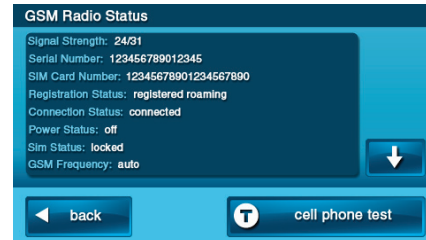

Figure 73. GSM Radio Info Screen

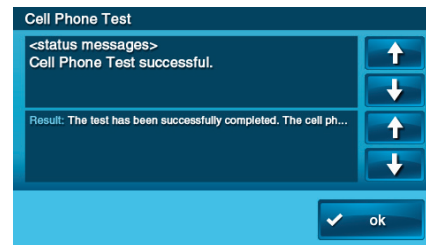

Figure 74. GSM Radio Test Screen

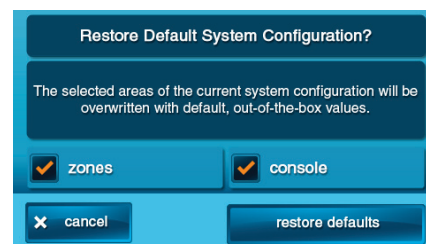

Figure 75. Restore Defaults Screen

Regulatory Information & Limited Warranty

Wireless Product Notice

Radio controls provide a reliable communications link and fill an important need in portable wireless signaling; however, there are some limitations which must be observed.

- For U.S. installations only: The radios are required to comply with FCC Rules and Regulations as Part 15 devices. As such, they have limited transmitter power and therefore limited range.
- A receiver cannot respond to more than one transmitted signal at a time and may be blocked by radio signals that occur on or near their operating frequencies, regardless of code settings.
- Changes or modifications to the device may void FCC compliance.
- Infrequently used radio links should be tested regularly to protect against undetected interference or fault.
- A general knowledge of radio and its vagaries should be gained prior to acting as a wholesale distributor or dealer, and these facts should be communicated to the ultimate users.

FCC Notice

This equipment generates and uses radio frequency energy and if not installed and used properly, that is, in strict accordance with the manufacturer's instructions, may cause interference to radio and television reception. It has been type tested and found to comply with the limits for a Class B computing device in accordance with Part 15 of FCC Rules, which are designed to provide reasonable protection against such interference in a residential installation. However, there is no guarantee that interference will not occur in a particular installation. If this equipment does cause interference to radio or television reception, which can be determined by turning the equipment off and on, the user is encouraged to try to correct the interference by one or more of the following measures:

- Relocate the Console away from the TV/radio receiver.
- Plug the Console into a different wall outlet so that the Console is on a different branch circuit.
- Re-orient the TV/radio antenna.
- If necessary, the user should consult the dealer or an experienced radio/television technician for additional suggestions.

FCC Telephone Rules and Regulations

The FCC requires that this alarm dialer system not make more than 15 repetitive dialing attempts to a single telephone number. There are no limitations when the calls are made sequentially to two or more alternative numbers, or when these calls are spaced 10 minutes apart to a single number. The FCC Rules and Regulations do not specify the re-attempt period as this can vary for specific applications. When setting this period, take into consideration local, interstate, foreign and special network call completion characteristics, network processing time, a sufficient number of rings and busy/don't answer modes.

Industry Canada Notices

NOTICE: The ringer equivalence number (REN) assigned to each terminal device provides an indication of the maximum number of terminals allowed to be connected to a telephone interface. The termination on an interface may consist of any combination of devices subject only to the requirement that the sum of the ringer equivalence numbers of all the devices does not exceed 5.

NOTICE: The Industry Canada label identifies certified equipment. This certification means that the equipment meets certain telecommunications network protective, operational and safety requirements. The Department does not guarantee the equipment will operate to the user's satisfaction.

Before installing this equipment, users should ensure that it is permissible to be connected to the facilities of the local telecommunications company. The equipment must also be installed using an acceptable method of connection. The customer should be aware that compliance with the above conditions may not prevent degradation of service in some situations.

Repairs to certified equipment should be made by an authorized Canadian maintenance facility designated by the supplier. Any repairs or alterations made by the user to this equipment, or equipment malfunctions, may give the telecommunications company cause to request the user to disconnect the equipment.

Users should ensure for their own protection that the electrical ground connections of the power utility, telephone lines and internal metallic water pipe system, if present, are connected together. This precaution may be particularly important in rural areas.

CAUTION: Users should not attempt to make such connections themselves, but should contact the appropriate electric inspection authority, or electrician, as appropriate.

Limited Warranty

This 2gig Technologies Inc. product is warranted against defects in material and workmanship for twelve (12) months. **This warranty extends only to wholesale customers** who buy through 2gig Technologies Inc. authorized distribution channels. **2gig Technologies Inc. does not warrant this product to consumers.** Consumers should inquire from their selling dealer as to the nature of the dealer's warranty, if any. **There are no obligations or liabilities on the part of 2gig Technologies Inc. for consequential damages arising out of or in connection with use or performance of this product or other indirect damages with respect to loss of property, revenue, or profit, or cost of removal, installation, or reinstallation.** All implied warranties, including implied warranties for merchantability and implied warranties for fitness, are valid only until the warranty expires. **This 2gig Technologies Inc. Warranty is in lieu of all other warranties express or implied.**

All products returned for warranty service require a Return Product Authorization Number (RPA#). Contact 2gig Technologies Inc. at 866-670-1591 for an RPA# and other important details.

Reference Programming Question Table

Q #	QUESTION	DEFAULT
Q-1 SUB-QUESTIONS	Select RF sensor # (01-48)	
	Select RF sensor (#) type	(00) unused
	Select RF sensor (#) equipment type	Varies by RF sensor type (Only shown for some sensor types)
	Select RF sensor (#) equipment code	(0000) other
	Enter RF sensor (#) other equipment code (0-9999)	0 (Only shown if other is selected)
	Enter RF sensor (#) serial number (7 digits)	0000000
	Select RF sensor (#) equipment age (0-1)	(0) new
	Select RF sensor (#) loop number (1-3)	Varies with sensor model selected
	Select RF sensor (#) dialer delay (0-1) ‡	(1) enabled (except for fire & CO)
	Construct RF sensor (#) voice descriptor	No default
	Select RF sensor (#) reports (0-1)	(1) enabled
	Select RF sensor (#) supervised (0-1)	(1) enabled
	Select RF sensor (#) chime (0-5)	(0) disabled
Q-2 SUB-QUESTIONS	Select wired sensor # (1-2)	
	Select wired sensor (#) type	(00) unused
	Select wired sensor (#) equipment type	Varies by wired sensor type (Only shown for some sensor types)
	Enter wired sensor (#) equipment code (0-9999)	0
	Select wired sensor (#) equipment age (0-1)	(0) new
	Select wired sensor (#) normal state	(0) not used
	Select wired sensor (#) dialer delay (0-1) ‡	(1) enabled
	Construct wired sensor (#) voice descriptor	No default
	Select wired sensor (#) reports (0-1)	(1) enabled
Select wired sensor (#) chime (0-5)	(0) disabled	
Q-3 SUB-QUESTIONS	Select fob # (1-8)	
	Select fob (#) used (0-1)	(0) unused
	Select fob (#) equipment code (0000)	(0000) other
	Enter fob (#) other equipment code (0-9999)	0 (Only shown if other is selected)
	Enter fob (#) serial number (7 digits)	0000000
	Select fob (#) equipment age (0-1)	(0) new
	Select fob (#) emergency key (0-4)	(0) disabled
	Select fob (#) key 2 can disarm (0-1)	(1) enabled
	Construct fob (#) voice descriptor	keyfob #
Select fob (#) arm no delay (0-1)	(0) disabled	
Select fob (#) key 4 output (0-2)	(0) disabled	
Q-4 SUB-QUESTIONS	Select RF keypad # (1-4)	
	Select RF keypad (#) used (0-1)	(0) unused
	Select RF keypad (#) equipment code	(0000) other
	Enter RF keypad (#) other equipment code (0-9999)	0 (Only shown if other is selected)
	Enter RF keypad (#) serial number (7 digits)	0000000
	Select RF keypad (#) equipment age (0-1)	(0) new
	Select RF keypad (#) emergency keys (0-1)	(1) enabled
Construct RF keypad (#) voice descriptor	keypad #	
Q-5	Enter exit delay, in seconds (45-120) ‡	60 seconds
Q-6	Enter entry delay 1, in seconds (30-240) ‡	30 seconds
Q-7	Enter entry delay 2, in seconds (30-240) ‡	45 seconds
Q-8	Select dialer (0-1)	(0) disabled
Q-9	Enter dialing prefix (0-4 digits)	No default
Q-10	Enter call waiting disable code (0-6 digits) ‡	No default
Q-11	Enter CS #1 phone number (0-25 digits)	No default
Q-12	Enter CS #1 account number (4 digits)	No default
Q-13	Select 2-way voice (0-2)	(1) stay on line
Q-14	Select silent panic/burglary listen only (0-1)	(1) enabled
Q-15	Select dialing type (0-1)	(0) touch tone
Q-16	Select police emergency key (0-2)	(1) audible
Q-17	Select fire emergency key (0-1)	(1) audible
Q-18	Select emergency key (0-1)	(1) audible
Q-19	Select quick arming (0-1)	(1) enabled
Q-20	Select swinger shutdown count (1-2) ‡	(1) one trip
Q-21	Select siren supervision time (0-3)	(0) disabled
Q-22	Enter CS lack of usage notification time (0-255)	7 Days
Q-23	Enter radio modem network failure time (0-255)	30 minutes
Q-24	Select radio modem network failure causes trouble (0-1)	(1) enabled
Q-25	Select radio modem network failure reports (0-1)	(1) enabled
Q-26	Select auto stay (0-1) ‡	(1) enabled
Q-27	Select exit delay restart (0-1) ‡	(1) enabled

Q #	QUESTION	DEFAULT
Q-28	Select quick exit (0-1)	(1) enabled
Q-29	Enter periodic test, in days (0-255)	30 days
Q-31	Enter cancel time, in minutes (5-255) ‡	5 minutes
Q-32	Select cancel display (0-1) ‡	(1) enabled
Q-33	Select cross sensor 47-48 (0-1)	(0) disabled
Q-34	Enter cross sensor timeout, in seconds (10-120)	10 seconds
Q-35	Select abort window dialer delay (0-2) ‡	(1) 30 seconds
Q-36	Select burglary bell cutoff (0-4)	(0) 4 minutes
Q-37	Select fire bell cutoff (0-4)	(0) 4 minutes
Q-38	Enter time to detect AC loss, in minutes (0-30)	10 minutes
Q-39	Select random AC loss report time (0-1)	(1) enabled
Q-40	Enter CS #2 phone number (0-25 digits)	No default
Q-41	Enter CS #2 account number (4 digits)	No default
Q-42	Select remote control phone (0-3)	(3) data and voice
Q-43	Enter installer code (4 digits)	1561
Q-44	Select lock installer programming (0-2)	(0) disabled
Q-45	Select lock default programming (0-2)	(0) default all
Q-46	Select trouble doesn't sound at night (0-1) ◆	(1) enabled
Q-47	Select trouble resound after holdoff (0-7)	(0) disabled
Q-48	Enter download csid (6 digits)	000000
Q-49	Select programming mode entry reports to CS (0-1)	(0) disabled
Q-50	Select trouble reports to CS (0-1)	(1) enabled
Q-51	Select manual bypass reports to CS (0-1)	(0) disabled
Q-52	Select AC loss reports to CS (0-1)	(1) enabled
Q-53	Select system low battery reports to CS (0-1)	(1) enabled
Q-54	Select RF low battery reports to CS (0-1)	(1) enabled
Q-55	Select opening reports to CS (0-1)	(0) disabled
Q-56	Select closing reports to CS (0-1)	(0) disabled
Q-57	Select alarm restore reports to CS (0-1)	(0) disabled
Q-58	Select trouble restore reports to CS (0-1)	(1) enabled
Q-59	Select bypass restores reports to CS (0-1)	(0) disabled
Q-60	Select AC restore reports to CS (0-1)	(1) enabled
Q-61	Select system low battery restore reports to CS (0-1)	(1) enabled
Q-62	Select RF low battery restores reports to CS (0-1)	(1) enabled
Q-63	Select phone fail detect (0-1)	(0) disabled
Q-64	Select smart test reports (0-1)	(0) disabled
Q-65	Select RF jam causes trouble (0-1)	(0) disabled
Q-66	Select daylight saving (0-1)	(1) enabled
Q-67	Select daylight saving start month (01-12)	(03) March
Q-68	Select daylight saving start Sunday (1-7)	(2) 2nd
Q-69	Select daylight saving end month (01-12)	(11) November
Q-70	Select daylight saving end Sunday (1-7)	(1) 1st
Q-71	Select system tamper causes trouble (0-1)	(1) enabled
Q-72	Select quick bypass (0-1)	(0) disabled
Q-73	Select disarming keyfob after alarm (alert) (0-1)	(0) disabled
Q-74	Select keyfob arm / disarm confirmation (0-1)	(0) disabled
Q-75	Select auto unbypass for manual bypass (0-1)	(1) enabled
Q-76	Select force bypass reports (0-1)	(0) disabled
Q-77	Select event log (0-3)	(3) all events
Q-78	Select output (00-10) ‡	(11) follows internal sounder alarm
Q-79	Select Z-Wave feature (0-3)	(1) disabled but visible
Q-80	Select Z-Wave switches feature (0-1)	(0) disabled
Q-81	Select Z-Wave thermostats feature (0-1)	(0) disabled
Q-82	Select Z-Wave door locks feature (0-1)	(0) disabled
Q-83	Select temperature display units (0-1)	(0) degrees Fahrenheit
Q-84	Select services require master code (0-1)	(0) disabled
Q-85	Select master user access to zwave toolbox (0-1)	(0) disabled
Q-86	Select disable siren after two-way audio (0-1)	(0) disabled

‡ Default set for SIA CP01 compliance

◆ For UL985 installations, this feature must be disabled

Reference System Vocabulary Table

#	WORD
002	ABORT
003	AC
004	ACCESS
005	ALARM
006	AND
007	ANNOUNCEMENT
008	AREA
009	ARM
010	ARMED
011	ARMING
012	AT
013	ATTIC
014	AUDIO
015	AUTO
016	AUTOMATION
017	AUXILIARY
018	AWAY
019	BABY'S
020	BACK
021	BASEMENT
022	BATHROOM
023	BATTERY
024	BEDROOM
025	BONUS
026	BREAK
027	BUTTON
028	BYPASS
029	BYPASSED
030	CABINET
031	CANCEL
032	CARBON MONOXIDE
033	CELLAR
034	CELLULAR
035	CELL RADIO
036	CENTER
037	CHECK
038	CHEST
039	CHILDREN'S
040	CHIME
041	CLOSET
042	CODE
043	COMMUNICATIONS
044	COMPUTER
045	CONTROL
046	COOL
047	CRAWL
048	CURRENT
049	DAY
050	DEGREES
051	DEN
052	DETECTOR
053	DIM
054	DINING
055	DISARM
056	DISARMED
057	DOCK
058	DOOR
059	DOWNSTAIRS
060	DRIVEWAY
061	EAST
062	EIGHT
063	EIGHTEEN
064	EIGHTY
065	ELECTRIC

#	WORD
066	ELEVEN
067	EMERGENCY
068	ENTER
069	ENTRANCE
070	ENTRY
071	ERROR
072	EXERCISE
073	EXIT
074	EXIT NOW
075	EXTERIOR
076	EXTERNAL
077	FAILURE
078	FAMILY
079	FAN
080	FIFTEEN
081	FIFTY
082	FIRE
083	FIRE ALERT
084	FIRE DETECTOR
085	FIRST
086	FIVE
087	FLOOD
088	FLOOR
089	FLUID
090	FOIL
091	FOR
092	FORTY
093	FOUR
094	FOURTEEN
095	FOURTH
096	FREEZE
097	FREEZER
098	FRONT
099	FURNACE
100	GAME
101	GARAGE
102	GAS
103	GLASS
104	GLASS BREAK
105	GUEST
106	GUN
107	HALL
108	HALLWAY
109	HANGING
110	HANG UP
111	HEAT
112	HIGH
113	HOME
114	HOUSE
115	ICE
116	INSIDE
117	INSTANT
118	INTERIOR
119	INTRUSION
120	IS
121	KEY
122	KEYFOB
123	KEYPAD
124	KIDS
125	KITCHEN
126	LAUNDRY
127	LEFT
128	LEVEL
129	LIBRARY

#	WORD
130	LIGHT
131	LIGHTS
132	LIQUOR
133	LIVING
134	LOADING
135	LOCK
136	LOFT
137	LOW
138	MAIN
139	MAINTENANCE
140	MASTER
141	MEDICAL
142	MEDICINE
143	MENU
144	MIDDLE
145	MONITOR
146	MOTION
147	MOTION DETECTOR
148	MUD
149	NINE
150	NINETEEN
151	NINETY
152	NORTH
153	NOT
154	NOT READY
155	NO DELAY
156	NO ENTRY DELAY
157	NURSERY
158	OFF
159	OFFICE
160	ON
161	ONE
162	ONE HUNDRED
163	OUTPUT
164	OUTSIDE
165	PANEL
166	PANIC
167	PANTRY
168	PATIO
169	PERIMETER
170	PHONE LINE
171	PLAY
172	POLICE
173	POOL
174	POUND
175	POWER
176	PRESS
177	PREVIOUS
178	PUMP
179	RADIO
180	READY
181	REAR
182	RELAY
183	REMOTE
184	REPEAT
185	RF JAM
186	RIGHT
187	ROOM
188	SAFE
189	SECOND
190	SECURITY
191	SENSOR
192	SENSORS
193	SESSION

#	WORD
194	SET
195	SEVEN
196	SEVENTEEN
197	SEVENTY
198	SHED
199	SHOP
200	SIDE
201	SILENT
202	SIREN
203	SIX
204	SIXTEEN
205	SIXTY
206	SKYLIGHT
207	SLIDING
208	SMOKE
209	SOUNDER
210	SOUTH
211	SPACE
212	SPARE
213	STAIRS
214	STAR
215	STATUS
216	STAY
217	STOP
218	STORAGE
219	STUDY
220	SUMP
221	SUPERVISION
222	SYSTEM
223	TAMPER
224	TEMPERATURE
225	TEN
226	TERMINATED
227	THERMOSTAT
228	THIRD
229	THIRTEEN
230	THIRTY
231	THREE
232	TO
233	TOOL
234	TRANSMITTED
235	TRANSMITTER
236	TROUBLE
237	TURN
238	TWELVE
239	TWENTY
240	TWO
241	UNLOCK
242	UPPER
243	UPSTAIRS
244	USER
245	UTILITY
246	VALVE
247	VOICE
248	WALL
249	WATER
250	WEST
251	WINDOW
252	WIRELESS
253	YARD
254	ZERO
255	ZONE

#'s

- 2GIG-AC1 replacement power supply 7
- 2GIG-ANT1 internal GSM antenna 7
- 2GIG-ANT1X external in-wall GSM antenna 7
- 2GIG-ANT2X external attic mount GSM antenna 7
- 2GIG-ANT4X 7
- 2GIG-BATT1 standard battery pack 7
- 2GIG-BATT1X extended battery pack 7
- 2GIG-DW10 thin door/window contact 6
- 2GIG-DW20R recessed door contact 6
- 2GIG-GB1 glass break detector 6
- 2GIG-GSMx GSM module 7
- 2GIG-KEY1 4-button key ring remote 6
- 2GIG-PANIC1 panic button remote 6
- 2GIG-PIR1 passive infrared motion detector 6
- 2GIG-SMKT2 smoke and heat detector 6
- 2GIG-TAKE-345 6
- 2GIG-TS1 Wireless touch screen keypad 6
- 2-way voice central station commands 30
- 2-way voice enable 30
- 4-button key ring remote 6
- 24-hour Audible Alarm sensor type 18
- 24-hour Auxiliary Alarm sensor type 18
- 24-hour Carbon Monoxide sensor type 18
- 24-hour Fire sensor type 18
- 24-hour Fire with Verification sensor type 18
- 24-hour Silent Alarm sensor type 18

A

- Abort window dialer delay 32
- AC loss detect time 33
- AC loss reports 35
- AC loss report time 33
- AC power icon 14
- AC restore reports 35
- Alarm restore reports 35
- Alarm sounder 9
- Alarm system permit 2
- Arming screen 12
- Auto stay 31

B

- BACK button 15
- Backlight timeout 39
- Backup battery connection 11
- Backup battery status icon 14
- Bell terminals 9
- BKSP button 15
- Block diagram 3
- Brightness / volume 39
- Burglary bell cutoff 32
- Bypass restore reports 35

C

- Call waiting disable code 30
- Cancel display 32
- Cancel time 32
- Central station #1 account number 30
- Central station #1 phone number 30
- Central station #2 account number 33
- Central station #2 phone number 33
- Central station commands for 2-way voice 30
- Closing reports 35
- Communicator telephone line 9
- Control panel external features 4
- Control panel features 4
- Control panel internal features 4
- Control panel location 5
- Control panel location height 5
- Control panel mounting 11
- Control panel mounting plate 8
- Control panel wiring 11
- Control panel wiring diagram 2
- Cross sensor 32
- Cross sensor timeout 32
- CS Lack of usage notification time 31

D

- Daylight saving end month 36
- Daylight saving end Sunday 36
- Daylight saving scheme 36
- Daylight saving start month 36
- Daylight saving start Sunday 36
- Day Zone sensor type 18
- DELETE button 15
- Dialer enable 30
- Dialing prefix 30
- Dialing type 31
- Disable siren after 2-way audio 38
- Disarming with key fob alert after alarm 36
- Download csid 34

E

- Emergency button 31
- END button 15
- Entry delay 1 30
- Entry delay 2 30
- ESC button 15
- ETL Listing 2
- Event log 37
- EXIT button 15
- Exit delay 30
- Exit delay restart 32
- Exit/Entry 1 sensor type 18
- Exit/Entry 2 sensor type 18
- Exiting programming 39
- Extended battery pack 7
- External attic mount GSM antenna 7
- External in-wall GSM antenna 7

F

- Fire bell cutoff 33
- Fire emergency key 31
- Force bypass reports 37
- FWD button 15

G

- Glass break detector 6
- GO TO button 15
- GSM module 7
- GSM module installation 10
- GSM radio icon 14
- GSM radio test 42

H

- Hardwired loops 8
- Home screen 12

I

- INSERT button 15
- Installation outline 5
- Installer code 33
- Installer code entry 13
- Installer programming 20, 22
- Installer toolbox 13
- Insurance discounts 2
- Interior follower sensor type 18
- Interior sensor open icon 14
- Interior with delay sensor type 18
- Internal GSM antenna 7

K

- Key fob # 27
- Key fob arm / disarm confirmation 36
- Key fob arm no delay 27
- Key fob emergency key 27
- Key fob equipment age 27
- Key fob equipment code 27
- Key fob key 2 can disarm 27
- Key fob key 4 output 27
- Key fob serial number 27
- key fob summary screen 26
- Key fob voice descriptor 27

L

- LEARN button 15
- Location of sensors 5
- Lock default programming 34
- Lock installer programming 34

M

- Manual bypass reports 34
- Master user access to Z-Wave Toolbox 38

Menu screen 12

N

Navigation arrows 15
 NFPA Standard #72 ii
 No response sensor type 18

O

Open collector output selection 37
 Opening reports 35

P

Panic button remote 6
 Passive infrared motion detector 6
 PASTE button 15
 Perimeter sensor type 18
 Periodic test timer 32
 Phone fail detect 35
 Phone line failure icon 14
 Police emergency key 31
 Power supply mounting 11
 Power supply wiring 11
 Programming mode entry reports 34
 Programming outline 16
 Programming question list 17

Q

Quick arming 31
 Quick bypass 36
 Quick exit 32

R

Radio modem network failure causes trouble 31
 Radio modem network failure reports 31
 Radio modem network failure time 31
 Radio status mode 42
 Recessed door contact 6
 Reference programming question table 44
 Reference system vocabulary 45
 Regulatory information 43
 Remote control phone enable 33
 Replacement power supply 7
 Restoring programming defaults 42
 RF jam causes trouble 36
 RF key fob programming 26
 RF key fob programming outline 26
 RF key fob programming steps 27
 RF key fob summary screen 26
 RF keypad # 29
 RF keypad emergency key 29
 RF keypad equipment age 29
 RF keypad equipment code 29
 RF keypad other equipment code 29
 RF keypad programming 28
 RF keypad programming outline 28
 RF keypad programming steps 29
 RF keypad serial number 29
 RF keypad summary screen 28
 RF keypad voice descriptor 29
 RF low battery reports 35
 RF low battery restore reports 35
 RF sensor # 22
 RF sensor chime 23
 RF sensor dialer delay 23
 RF sensor equipment age 23
 RF sensor equipment code 22
 RF sensor equipment type 22
 RF sensor loop number 23
 RF sensor other equipment code 22
 RF sensor programming 20
 RF sensor programming outline 20
 RF sensor programming steps 22
 RF sensor reports 23
 RF sensor serial number 23
 RF sensor summary screen 21
 RF sensor supervised 23
 RF sensor type 22
 RF sensor voice descriptor 23
 RJ31X telephone jack 9

S

Saving programming 39
 Security screen 12
 Sensor signal loss through materials 5
 Sensor types 18
 Sensor zones 18
 Services menu requires master code 38

Set date / time 39
 SET TIME button 39
 SHIFT button 15
 Signal strength indicators 41
 Silent burglary sensor type 18
 Silent panic/burglary listen only 30
 Siren supervision time 31
 SKIP button 15
 Smart test reports 36
 Smoke and heat detector 6
 Smoke detector location ii
 Solid state output 9
 Sounder disable/enable 40
 Sounder disable icon 14
 Standard battery pack 7
 Status screen 12
 SUM button 15
 Super switch wireless takeover module 6
 Swinger shutdown count 31
 System block diagram 3
 System configuration screen 13
 System low battery reports 35
 System low battery restore reports 35
 System sensor types 18
 System status icons 14
 System tamper causes trouble 36
 System vocabulary 19

T

Takeover module 6
 Telephone line 9
 Telephone test 42
 Temperature display units 37
 Testing the system 40
 Test mode icon 14
 Thin door/window contact 6
 Toolbox screens 13
 Touch screen keypad traffic icon 14
 Trouble doesn't sound at night 34
 Trouble reports 34
 Trouble resound after holdoff 34
 Trouble restore reports 35

U

Unused zone 18
 User Management 39

V

Vocabulary 19

W

Walk test mode 41
 Wall mounting control panel 8
 Wired sensor # 25
 Wired sensor chime 25
 Wired sensor dialer delay 25
 Wired sensor equipment code 25
 Wired sensor equipment type 25
 Wired sensor normal state 25
 Wired sensor programming 24
 Wired sensor programming outline 24
 Wired sensor programming steps 25
 Wired sensor reports 25
 Wired sensor summary screen 24
 Wired sensor type 25
 Wired sensor voice descriptor 25
 Wireless installation tips 5
 Wireless keypad 6
 Wireless sensor installation 8
 Wireless takeover module 6
 Wireless touch screen keypad 6
 Wiring diagram 2

Z

Zone reporting test 40
 Zone types 18
 Z-Wave door locks feature 37
 Z-Wave feature enable 37
 Z-Wave switches feature 37
 Z-Wave thermostats feature 37



Tech Support: 855.2GIG.TECH
855.244.4832
www.2gig.com